

# THE WORLD OF LAPP

Products for wind energy



**BASE**  
AUTOMAÇÃO



**LAPP GROUP**



## Welcome

To contact your local Lapp Group representative please visit [www.lappgroup.com/worldwide](http://www.lappgroup.com/worldwide)

# BASE AUTOMAÇÃO

 (11) 4456-4321  (11) 97885-1596

 [COMERCIAL@BASEAUTOMACAO.COM.BR](mailto:COMERCIAL@BASEAUTOMACAO.COM.BR)

 [WWW.BASEAUTOMACAO.COM.BR](http://WWW.BASEAUTOMACAO.COM.BR)











Image source title: PowerWind GmbH/J. Meier, Fotolia

07/1



## Welcome

To contact your local Lapp Group representative please visit [www.lappgroup.com/worldwide](http://www.lappgroup.com/worldwide)

	<b>Informations about the company</b>	<b>2</b>
	<b>Information on wind energy</b>	<b>6</b>
	<b>ÖLFLEX®</b> Power- and control cables	<b>17</b>
	<b>UNITRONIC®</b> Data communication systems	<b>62</b>
	<b>ETHERLINE®</b> Data communication systems for ETHERNET-Technology	<b>81</b>
	<b>HITRONIC®</b> Optical transmission systems	<b>87</b>
	<b>EPIC®</b> Industrial connectors	<b>94</b>
	<b>SKINTOP®</b> Cable glands	<b>97</b>
	<b>SILVYN®</b> Protective cable conduit- and cable carrier systems	<b>113</b>
	<b>FLEXIMARK®</b> Marking systems	<b>118</b>
	<b>Cable Accessories</b>	<b>121</b>

## Brand quality from Stuttgart



### **ÖLFLEX®** **Power- and control cables**

The world's first brand cable is available in the most varied of versions to match maximum requirements.

**Key features:** Oil-resistant, flexible and available to match almost any requirement or environmental condition – also free of halogens.

**Fields of application:** Multipurpose. Special variants are more and more in demand in the area of renewable energies.



### **EPIC®** **Industrial connectors**

The brand for strong and reliable connections.

**Key features:** Robust square and circular connectors. Flexible system consisting of housings, inserts, contacts and accessories – for every requirement, the tailor-made solution. Similarly, EPIC® SOLAR plugs for photovoltaics are also part of the extensive product range.

**Fields of application:** Mechanical and systems engineering, drive technology, Automation.

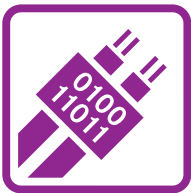

### **UNITRONIC®** **Data communication systems**

The ideal brand for fast, trend-setting and reliable data transfer.

**Key features:** UNITRONIC® are not only data lines, but also bus lines, which together with active sensor/actuator modules or gateways provide a perfect system for automation.

**Fields of application:** Measurement, control, regulation, bus or LAN networks.



### **SKINTOP®** **Cable glands**

The brand for multipurpose cable entries in line with the following: quickly fastened, centred and hermetically sealed.

**Key features:** Large clamping areas, optimum strain reliefs, the most diverse of versions such as SKINTOP® CLICK, COLD or CUBE.

**Fields of application:** Everywhere, where cables must be fastened reliably and quickly.

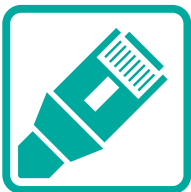

### **ETHERLINE®** **Data communication systems for ETHERNET-Technology**

The brands for network solutions, safety systems and firewalls in the industrial networking sector.

**Key features:** System solutions consisting hardware, software, consulting, network design and support.

**Fields of application:** Factory automation, Renewable Energy, Building technology, Structured cabling.



### **SILVYN®** **Protective cable conduit- and cable carrier systems**

The brand for all-round cable protection.

**Key features:** The product range includes SILVYN® cable protection hoses for perfect protection against mechanical and chemical loads, along with SILVYN® CHAIN energy supply chains for highly-dynamic applications.

**Fields of application:** Everywhere that cables have to be additionally protected or routed.



### **HITRONIC®** **Optical transmission systems**

The brand for split-second, fault-free, intercept-free data transport.

**Key features:** The HITRONIC® product range includes fibre optic cables in the most varied of versions, along with suitable accessories such as splice boxes, wall distributors or couplings.

**Fields of application:** Office and industrial sector, Renewable Energy.



### **FLEXIMARK®** **Marking systems**

The brand for permanent, clearly-arranged cable markings.

**Key features:** Comprehensive range – from manual labelling solutions onto digital identification. Withstands high chemical, thermal and mechanical loads.

**Fields of application:** All cable, single cores, control cabinets.

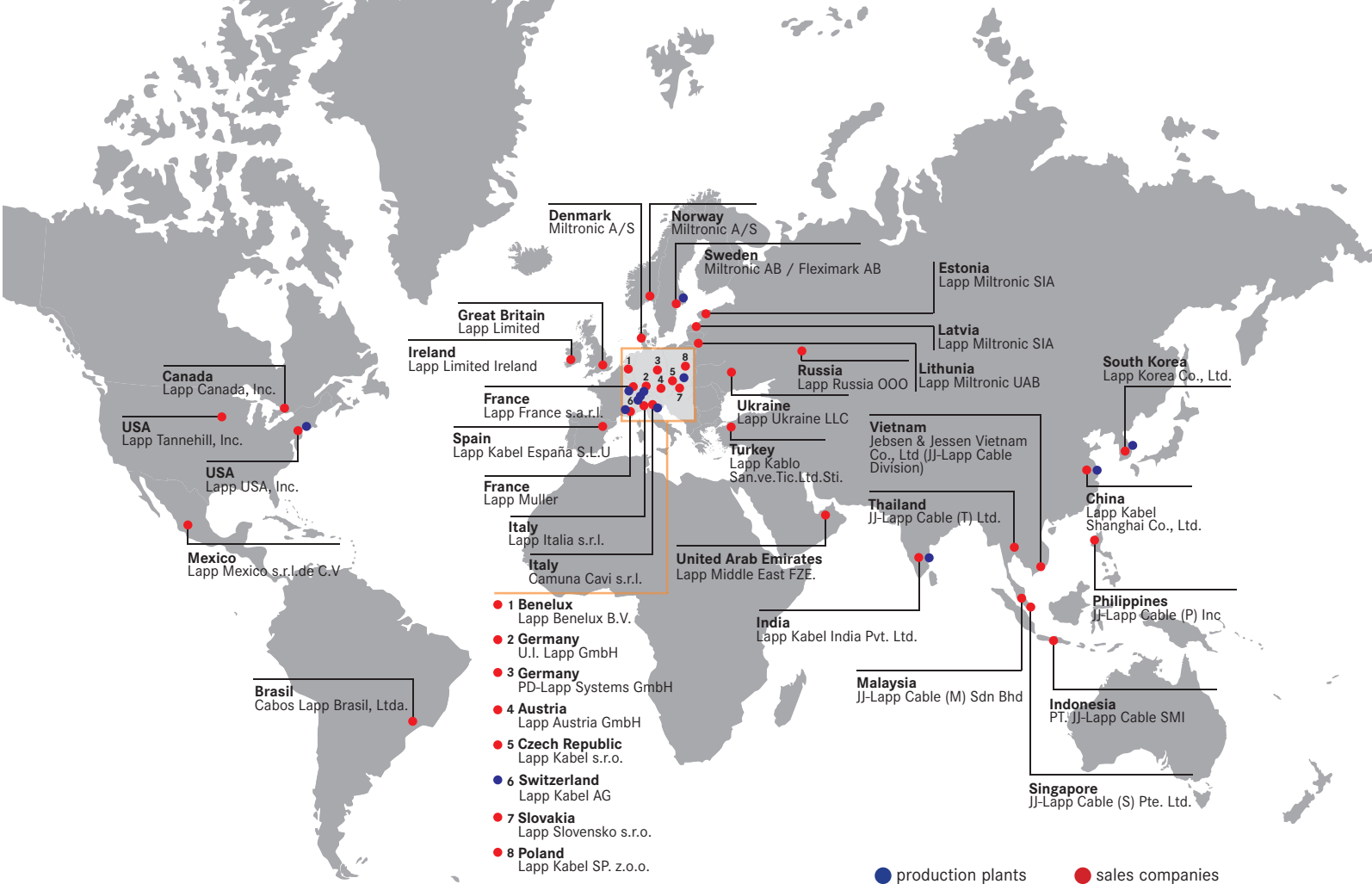

## At home in Stuttgart, but known all over the world

The World of Lapp is based in Stuttgart. This is where it all started for our company, which was founded in 1959 as U.I. Lapp KG (now U.I. Lapp GmbH). From its headquarters in Stuttgart we have determinedly evolved to become a global player – with currently 15 production plants in Europe, Asia and America, 41 sales companies and more than 100 sales partners, 3,000 employees. The larger Lapp companies such as Russia, India, China, Canada and Mexico have their own warehouses. The others are promptly supplied through our high-performance logistics centres. At our Lapp Centres we are also strongly committed to enhancing the knowledge of our employees and customers. After all, knowledge is the ink with which the future is written down.

One of our most successful “products” is that of proximity to our customers. On the one hand, we practice intensive dialogue with designers and planners, manufacturers and users. This enables us to identify new requirements and trends at a much earlier stage, to quickly provide you with suitable solutions. Innovation leadership put into active practice.

On the other hand, proximity to our customers really means something to us: our presence extends all round the globe. As a reliable partner on a local basis we support our customers in exploiting markets by providing them with short delivery times and low logistics costs.

Our current addresses see [www.lappgroup.com/worldwide](http://www.lappgroup.com/worldwide)





**Korea**  
**Lapp Korea LLC.**  
 759-5, Kumeu-ri  
 JangAn-Myeon, HWASUNG CITY  
 KyungGi Province  
 South Korea 445-941  
 Tel.: +82 31 2501011  
 Fax: +82 31 2501019  
 jin.min@lappgroup.com  
 www.lappkorea.com



**Latvia**  
**LAPP MILTRONIC SIA**  
 Ulbrokas 44a  
 RĪGA, 1021  
 Tel.: +371 67 501900  
 Fax: +371 67 501909  
 pasutijumi@lappmiltronic.lv  
 www.lappmiltronic.lv



**Libya**  
**Al Jouda Co.**  
 Al Fath – Street  
 Al Buraq – Building 3rd floor  
 BENGHAZI  
 Tel.: +218 91 7433363  
 ilsharee@yahoo.co.uk



**Lithuania**  
**LAPP Miltronic UAB**  
 P. Vileisio 18N  
 10306 VILNIUS  
 Tel.: +370 5 2780390  
 Fax: +370 5 2780397  
 info@lappmiltronic.lt  
 www.lappmiltronic.lt



**Macedonia**  
**Siskon Doel**  
 Taskenska 4A  
 1000 SKOPJE  
 Tel.: +389 2 3062423  
 Fax: +389 2 3061250  
 siskon@mt.net.mk  
 www.siskon.com.mk



**Malaysia**  
**JJ-LAPP Cable (M) Sdn Bhd**  
 16, Jalan 51A/225,  
 46100 PETALING JAYA SELANGOR  
 Tel.: +603 78 616288  
 Fax: +603 78 616299  
 sales\_jjim@jjssea.com  
 www.jj-lappcable.com



**Malta**  
**G & E Electronics Ltd.**  
 Genics Bldgs.  
 Giov. Papafy Str.  
 B'KARA BKR 4021  
 Tel.: +356 21 486816  
 Fax: +356 21 497103  
 info@gemalta.com  
 www.gemalta.com



**Mexico**  
**Lapp Mexico s de rl de C.V.**  
 Metalurgia # 2730  
 Industrial El Alamo C.P.  
 44490 TLAQUEPAQUE, Jalisco  
 Tel.: +52 33 36660250  
 Fax: +52 33 36660075  
 ventas@lappmexico.com  
 www.lappmexico.com



**Republic of Moldova**  
**Licuri SRL**  
 Bd. Moskova, 20  
 2045 MUN. CHISINAU  
 Tel.: +373 22 402536, 329436  
 Fax: +373 22 404777  
 office@licuri.md  
 www.licuri.md



**Mongolia**  
**MCS International Co. Ltd.**  
 MCS Anun centera Khan-Uul  
 districta 3rd khoroo  
 ULAANBAATAR  
 Tel.: +976 11 346363  
 Fax: +976 11 346030  
 galbadrakh@mcs.mn  
 www.international.mcs.mn



**Morocco**  
**FIABEL Sari MAROC**  
 56 Résidence Najmat Bahmad  
 Bd Bahmad – Belvédère  
 CASABLANCA  
 Tel.: +212 22 4033-01, -02  
 Fax: +212 22 403303  
 stefiabel@menara.ma  
 www.fiabel.com



**Netherlands**  
**Lapp Benelux B.V.**  
 Van Dijkstraan 16,  
 5581 WG WAALRE  
 Postbus 74, 5580 AB WAALRE  
 Tel.: +31 40 2285000  
 Fax: +31 40 2285010  
 info.lappbenelux@lappgroup.com  
 www.lappbenelux.com



**New Zealand**  
**Engineering Computer Services Ltd.**  
 530 Te Rapa Road  
 P.O. Box 20204  
 HAMILTON  
 Tel.: +64 7 8492211  
 Fax: +64 7 8492220  
 garry@lappgroup.co.nz  
 www.lappgroup.co.nz



**Nicaragua**  
**EL-TEC**  
 De la óptica Nicaraguense  
 3c al Este, 1/2 c al Sur  
 Residencial Bolonia, MANAGUA  
 Tel.: +505 2254-4913  
 info@el-tec.com  
 www.el-tec.com



**Nigeria**  
**Penz Williams Limited**  
 Suite 7 Canaan Mall, Plot 2  
 Block 105 LEKKI  
 LAGOS  
 Tel.: +234 8 037448810  
 Fax: +234 8 4612169  
 info@penzwilliams.com  
 www.penzwilliams.com



**Norway**  
**Miltronic AS**  
 Eikveien 11  
 3036 DRAMMEN  
 Tel.: +47 32 261300  
 Fax: +47 32 261398  
 info@miltronic.no  
 www.miltronic.no



**Panamá**  
**CONTEC, S.A.**  
 Consultores Electrotécnicos, S.A.  
 Vía Tocumen  
 Plaza el conquistador, local # 10  
 PANAMÁ  
 Tel.: +507 233 5-1199, -1469  
 Fax: +507 233 6028  
 ycardenas@contecpma.com  
 www.contecpanama.com



**Peru**  
**DESIMAT PERU**  
 Av. Velasco Astete 2371  
 Surco LIMA  
 Tel.: +51 1 2752765  
 Fax: +51 1 2752776  
 ventas@desimat.com.pe  
 www.desimat.com.pe



**Philippines**  
**JJ-LAPP Cable (P) Inc**  
 Unit 704, Philiplans Corporate Center  
 1012 Triangle Drive  
 Bonifacio Global City  
 1634 TAGUIG CITY, MANILA  
 Tel.: +632 786 7566  
 Fax: +632 786 7544  
 sales\_jjlp@jjssea.com  
 www.jj-lappcable.com



**Poland**  
**Lapp Kabel Sp. z o.o.**  
 ul. Wroclawska 33 D  
 Dlugoleka, 05-095 MIRKÓW  
 Tel.: +48 71 3306300  
 Fax: +48 71 3306306  
 info@lapppolska.pl  
 www.lapppolska.pl

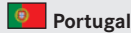

**Portugal**  
**Policabos S.A.**  
 Av. Pedro Álvares Cabral  
 Lugar da Capa Rota  
 2710-144 SINTRA  
 Tel.: +351 21 9178640  
 Fax: +351 21 9178649  
 policabos@policabos.pt  
 www.policabos.pt

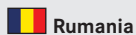

**Rumania**  
**COELCO TRADE**  
 Autostrada Bucuresti-Pitesti, km 13,5  
 A1 ind. park Polo Occidente/Hala M  
 Judet ILFOF, 077096  
 Tel.: +40 213 1009-61, -62  
 Fax: +40 213 1009-59, -89  
 coelco@dnt.ro  
 www.coelco.ro



**Russia**  
**Lapp Russia OOO**  
 Leninskaya St., 141  
 443041 SAMARA  
 Tel.: +7 846 3731717  
 Fax: +7 846 2760291  
 lapprossia@lappgroup.ru  
 www.lappgroup.ru



**Serbia**  
**Vesimpex d.o.o.**  
 Petra Konjovića 12v  
 Poslovnj centar-Rakovica, ulaz C  
 11090 BEOGRAD  
 Tel.: +381 11 3510-683  
 Fax: +381 11 3057-947  
 info@vesimpex.rs  
 www.vesimpex.rs



**Singapore**  
**JJ-LAPP Cable (S) Pte Ltd**  
 No.9 Tuas South St 3  
 SINGAPORE 638017  
 Tel.: +65 6 5086200  
 Fax: +65 6 8631271  
 sales\_jjs@jjssea.com  
 www.jj-lappcable.com



**Slovakia**  
**LAPP SLOVENSKO, s.r.o.**  
 Piaristicka 2  
 949 24 NITRA  
 Tel.: +421 376 578095  
 Fax: +421 376 578096  
 info@lappgroup.sk  
 www.lappgroup.sk



**Slovenia**  
**FINEA TRADE d.o.o.**  
 Limbuška cesta 2  
 2000 MARIBOR  
 Tel.: +386 2 4213555  
 Fax: +386 2 4213571  
 elektro@finea-trade.si  
 www.finea-trade.si



**South Africa**  
**Lapp Group Southern Africa**  
 51 Brunton Circle  
 Founders View South  
 Modderfontein  
 1645 GAUTENG  
 Tel.: +27 11 2013200  
 Fax: +27 11 6095850  
 info@lappkabel.co.za  
 www.lappcable.co.za



**Spain**  
**Lapp Grupp España**  
 Avda. de les Garrigues, 34 – 36, Nave 1  
 Parque Empresarial Mas Blau II  
 08820 EL PRAT DE LLOBREGAT  
 (Barcelona)  
 Tel.: +34 902 108 669  
 Fax: +34 934 796 272  
 info@lappgroup.es  
 www.lappgroup.es



**Sweden**  
**Miltronik AB**  
 Kungshagsvägen 7  
 P.O. Box 1022  
 611 29 NYKÖPING  
 Tel.: +46 155 77700  
 Fax: +46 155 77701  
 info@miltronic.se  
 www.miltronic.se



**Sales office Denmark**  
**Korskildeeng 6**  
 2670 GREVE  
 Tel.: +45 43 950000  
 Fax: +45 43 950009  
 info@miltronic.dk  
 www.miltronic.dk



**Switzerland**  
**Volland AG**  
 Ifangstrasse 103  
 8153 RÜMLANG  
 Tel.: +41 44 8179797  
 Fax: +41 44 8179700  
 info@volland.ch  
 www.volland.ch



**EPIC®**  
**Bachofen AG**  
 Ackerstraße 42  
 8610 USTER  
 Tel.: +41 44 9441111  
 Fax: +41 44 9441233  
 info@bachofen.ch  
 www.bachofen.ch



**Taiwan**  
**DKSH Taiwan Ltd.**  
 10th Floor, No. 22, Lane 407  
 Tiding Blvd., Sec. 2  
 Neihu Technology Park  
 TAIPEI CITY 114-93  
 Tel.: +886 2 87527651  
 Fax: +886 2 87518688  
 paul.lin@dksh.com



**Thailand**  
**JJ-LAPP Cable (T) Ltd**  
 23/110-117 Sorachai Building  
 25-29th FL  
 Soi Sukhumvit 63 (Ekamai),  
 Sukhumvit Road, Klongton Nua,  
 Wattana, BANGKOK 10110  
 Tel.: +66 27 878288  
 Fax: +66 27 878299  
 sales\_jjlt@jjssea.com  
 www.jj-lappcable.com



**Turkey**  
**LAPP KABLO San.ve.Tic.Ltd.Şti.**  
 Atatürk Bulvarı  
 Ayanoğlu İş Merkezi No: 1  
 34758 ATAŞEHİR – İstanbul  
 Tel.: +90 216 4565699  
 Fax: +90 216 45656-87, -89  
 info@lapp.com.tr  
 www.lapp.com.tr



**Ukraine**  
**Lapp Ukraine LLC**  
 201 – 203, Kharkivske shose  
 02121 KIEV  
 Tel.: +38 044 495-6000  
 Fax: +38 044 490-7630  
 info@lappukraine.com  
 www.lappukraine.com



**United Arab Emirates**  
**LAPP CABLES MIDDLE EAST FZE**  
 Wing A-502, P.O. Box 341223  
 Dubai Silicon Oasis  
 DUBAI  
 Tel.: +971 4 3712905  
 Fax: +971 4 3712918  
 lappme@lappgroup.com  
 www.lappgroup.com



**Uruguay**  
**Reprinter LTDA.**  
 Avda. Italia 6481  
 MONTEVIDEO  
 Tel.: +598 2600-7343  
 Fax: +598 2600-8658  
 lapp@reprinter.com.uy  
 www.reprinter.com.uy



**USA**  
**Lapp USA, Inc.**  
 29 Hanover Road  
 FLORHAM PARK, NJ 07932  
 Tel.: +1 973 6609700  
 Fax: +1 973 6609330  
 sales@lappusa.com  
 www.lappusa.com



**Lapp Tannehill, Inc.**  
 8675 Eagle Creek Parkway Suite 900  
 SAVAGE, MN 55378  
 Tel.: +1 952 8816700  
 Fax: +1 952 8810743  
 sales@lapptannehill.com  
 www.lapptannehill.com



**Uzbekistan**  
**Elektro-Potential LLC**  
 2b, G. Mavlyanov str. off. 311  
 100084 TASHKENT  
 Tel.: +99 898 3003821  
 Fax: +99 871 1249286  
 mz1958@yandex.ru



**Venezuela**  
**Somerinca C.A.**  
 3era Transversal Dos Caminos  
 Quinta Corazon de Jesús  
 1070 CARACAS  
 Tel.: +58 212 2373003  
 Fax: +58 212 2399341  
 kloccoeller@cantv.net



**Vietnam**  
**Jebsen & Jessen Vietnam Co., Ltd**  
 (JJ-Lapp Cable Division)  
 Sailing Tower, Unit 1206, 12 floor,  
 111A, Pasteur Street, District 1  
 HO CHI MINH CITY  
 Tel.: +848 35 103411  
 Fax: +848 6288 7688  
 sales\_jjlv@jjssea.com  
 www.jj-lappcable.com



# Lapp products for a wind turbines without UL/CSA requirements

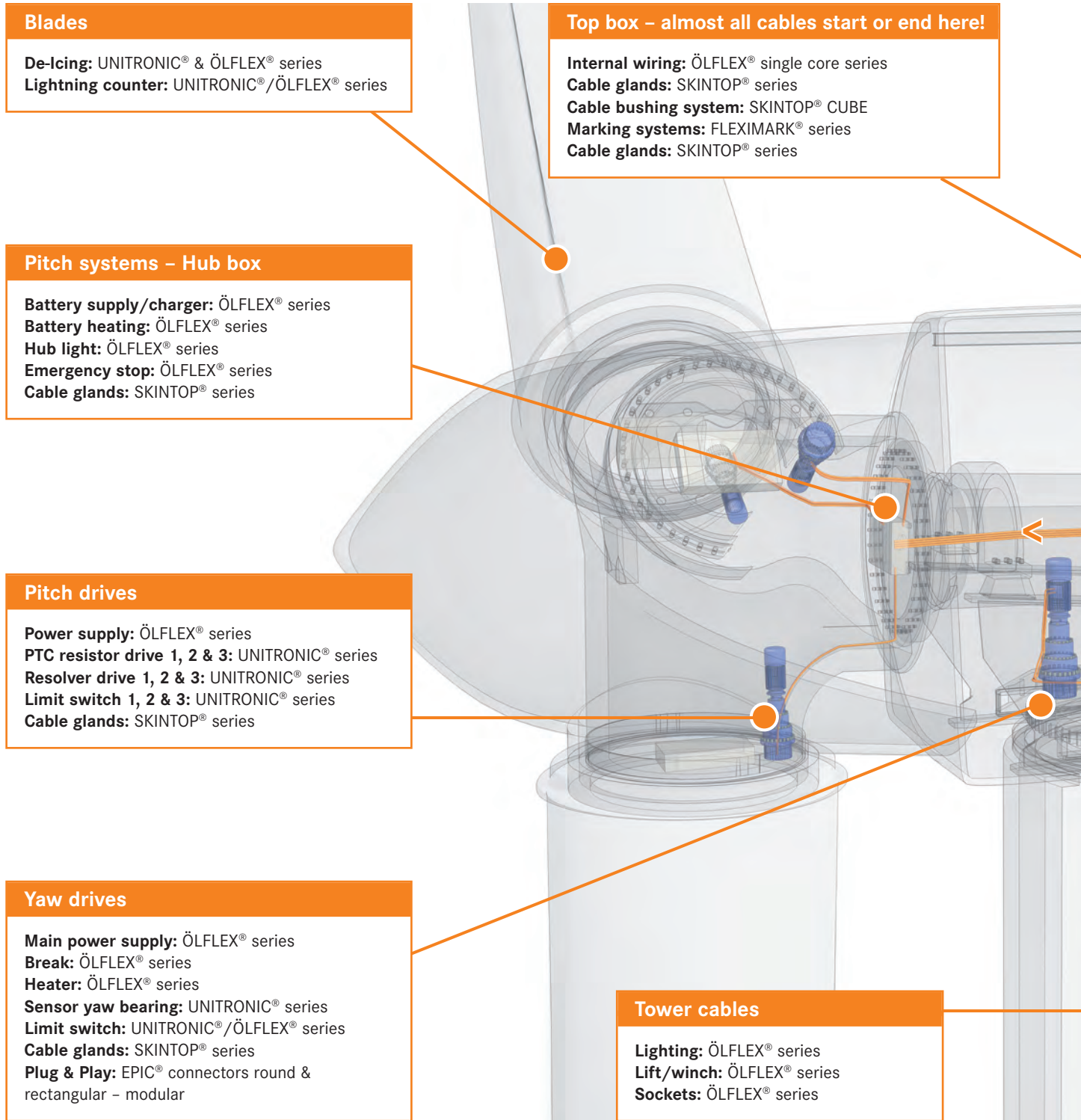

No matter which conditions – Lapp will have a suitable product. Here some samples.

Product	Properties
ÖLFLEX® CLASSIC 100/100 CY	300/500 V & 450/750 V, fixed temp.: -40 °C to +80 °C, small OD, god chemical resistance.
ÖLFLEX® CLASSIC 110/110 CY	300/500 V, fixed installation temp.: -40 °C to +80 °C, small OD, god chemical resistance.
ÖLFLEX® CLASSIC 110 COLD	300/500 V, fixed installation temp. -40 °C to +80 °C, occasional flexing temp.: -30 °C to +70 °C, UV & ozone resistant, small OD, god chemical resistance.
ÖLFLEX® CLASSIC 100 BK POWER 0,6/1kV	0,6/1 kV, fixed installation temp. -40 °C to +80 °C, occasional flexing temp.: -30 °C to +70 °C, UV & ozone resistant, small OD, god chemical resistance.
ÖLFLEX® CLASSIC 110 & 110 CY BLACK 0,6/1kV	Fixed installation temp.: -40 °C to +80 °C, occasional flexing temp.: -30 °C to +70 °C, UV & ozone resistant, small OD, god chemical resistance.

### Gear box

**Heating/cooling:** ÖLFLEX® series  
**Cooling fluid pressure gauge:** UNITRONIC® series  
**Sensors PT 100:** UNITRONIC® series  
**Signals (Gear box to Top box):** UNITRONIC® series  
**Temperature bearings:** UNITRONIC® series  
**Cable glands:** SKINTOP® series

### Slip ring – Hub box connection

**Supply drives/control:** ÖLFLEX® series  
**Batteries supply:** ÖLFLEX® series  
**Signals:** ÖLFLEX® series  
**CAN-Bus:** UNITRONIC® Bus-CAN  
**Ethernet:** ETHERLINE® series  
**Heating:** ÖLFLEX® series  
**Cable glands:** SKINTOP® series  
**Plug & Play:** EPIC® connectors round & rectangular – modular

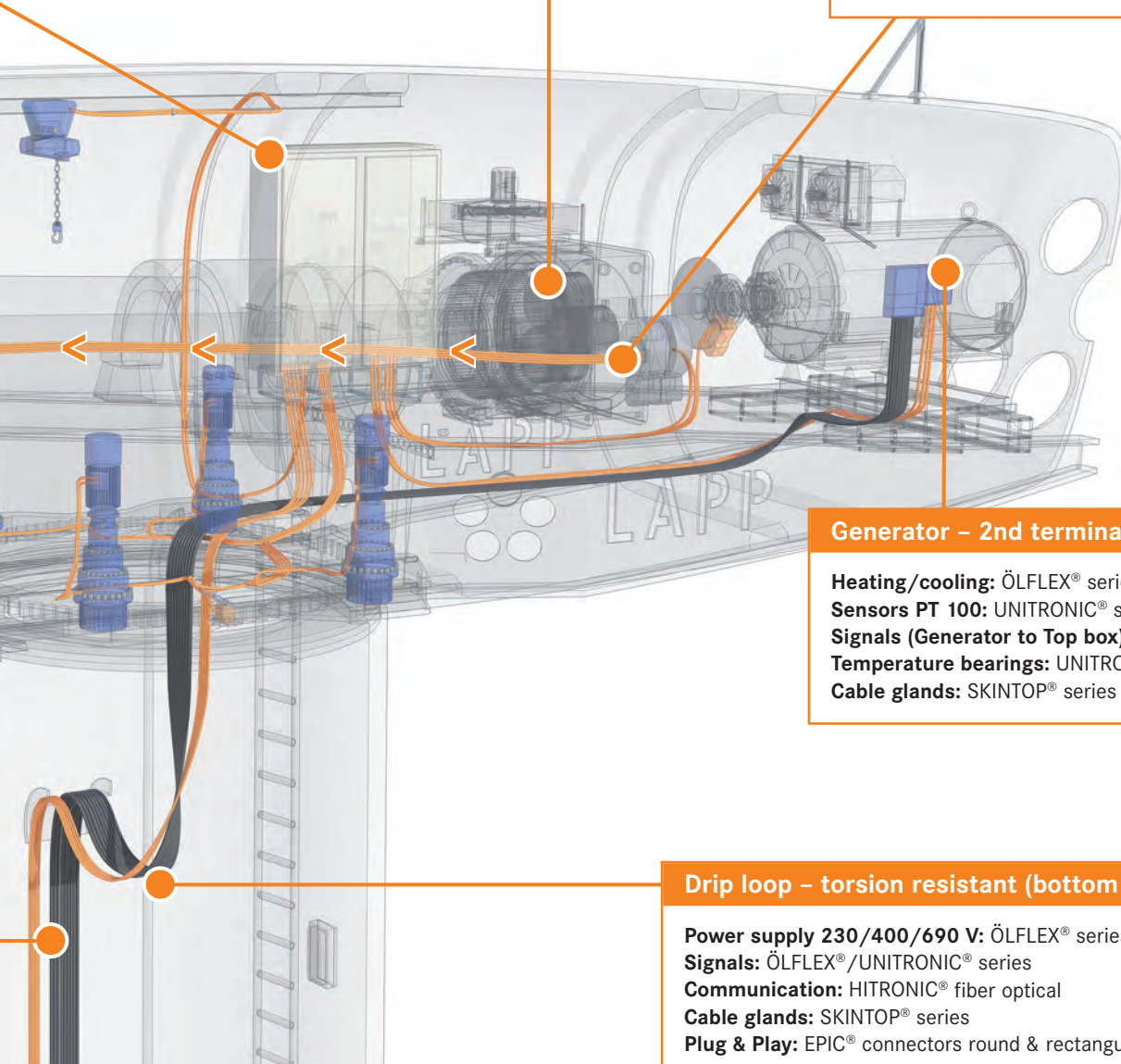

### Generator – 2nd terminal box

**Heating/cooling:** ÖLFLEX® series  
**Sensors PT 100:** UNITRONIC® series  
**Signals (Generator to Top box):** UNITRONIC® series  
**Temperature bearings:** UNITRONIC® series  
**Cable glands:** SKINTOP® series

### Drip loop – torsion resistant (bottom to Top box)

**Power supply 230/400/690 V:** ÖLFLEX® series  
**Signals:** ÖLFLEX® /UNITRONIC® series  
**Communication:** HITRONIC® fiber optical  
**Cable glands:** SKINTOP® series  
**Plug & Play:** EPIC® connectors round & rectangular – modular

Product	Properties
ÖLFLEX® CLASSIC 191/191 CY	UL AWM, HAR: 300/500 V/UL/CSA: 600 V, fixed installation temp.: UL/CSA: -40 °C to +90 °C/HAR: -40 °C to +80 °C, good chemical resistance.
ÖLFLEX® TORSION	IEC/VDE 0,6/1 kV, UL/CSA: 1000 V, fixed installation acc. UL temp.: -40 °C to +90 °C, flexible acc. UL: -35 °C to +90 °C, torsion: ±150 °/m., UV und ozone resistant.
UNITRONIC® LIYCY & LIYCY	350/500 V, fixed installation temp.: -40 °C to +80 °C, flame retardant acc. IEC 60332-1-2.
UNITRONIC® FD CP (TP) plus	250 V, UL/CSA CMX, fixed installation temp.: -40 °C to +80 °C, halogen free.
SKINTOP® BRUSH	360 ° EMC gland, VDE, UL, CSA, static temp.: -40 °C to +100 °C, dynamic temp.: -30 °C to +100 °C, IP 68.
ETHERLINE®	Highly flexible, Cat. 5e FD, 100 Ω ± 15 Ω, fixed installation temp.: -30 °C to +80 °C.

# North American market – Lapp products for a UL/CSA version

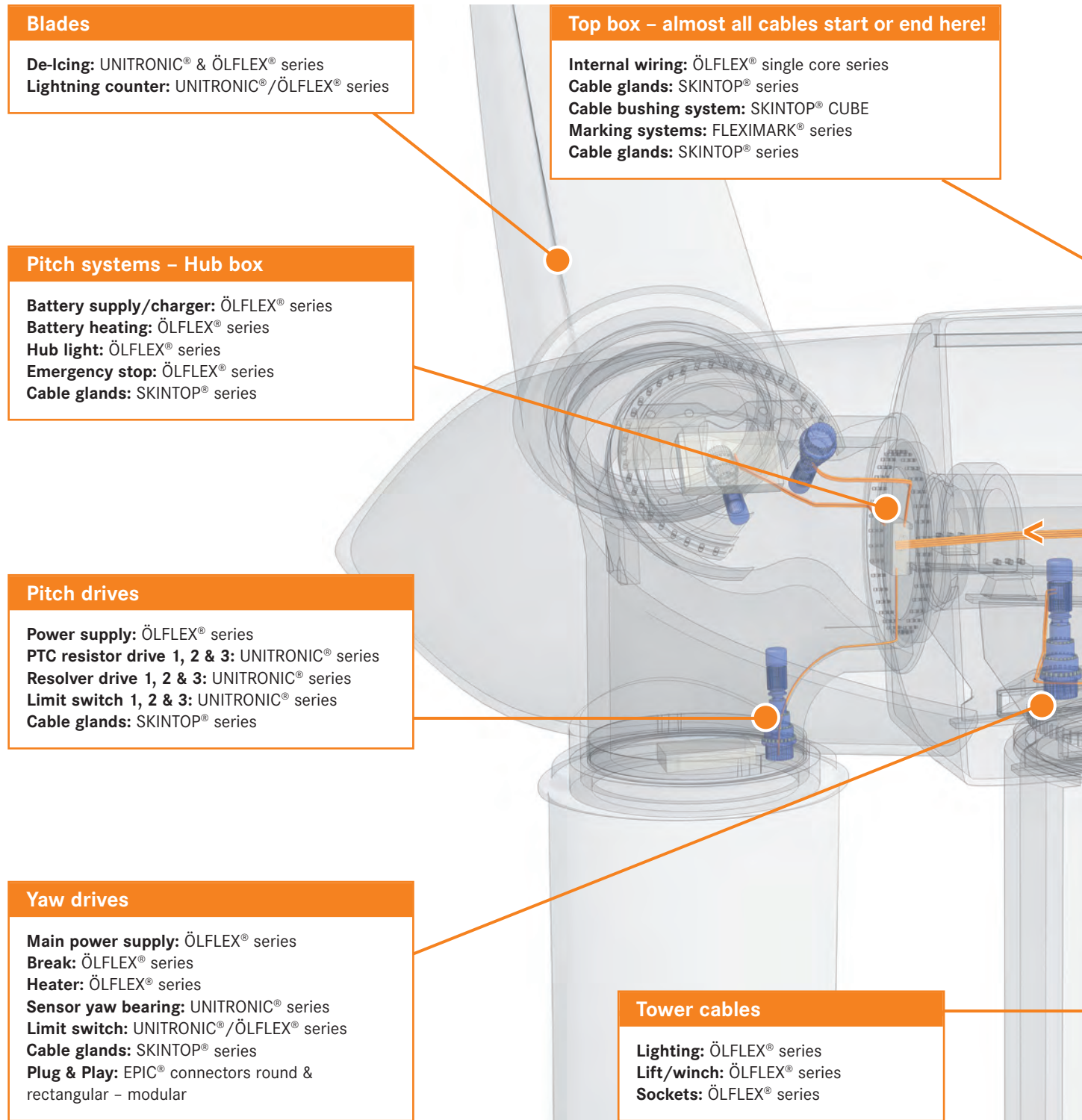

No matter which conditions – Lapp will have a suitable product. Here some samples.

Product	Properties
ÖLFLEX® 190*	Highly flexible, oil res. I & II, UL MTW, CSA AWM, FT1.
ÖLFLEX® TRAY II & CONTROL TM	Highly flexible, oil res. I & II, UL WTTC 1000 V, CSA CIC/TC, FT4, -40 °C cold bend, -25 °C cold impact, torsion resistant.
ÖLFLEX® FORTIS	Cold flexible, oil res. I & II, UL WTTC 1000 V, CSA CIC/TC, FT4, -40 °C cold bend, -40 °C cold impact, torsion resistant.
ETHERLINE®	Cat 5e, 100 Ω ± 15 Ω, UL/CSA CMG, FT4.
ETHERLINE® TORSION	Highly flexible, cat 5e, 100 Ω ± 15 Ω, UL/CSA CMG, torsion resistant, FT1.
UNITRONIC® 300 CY	Highly flexible, UL PLTC/CMG, CSA CMG, oil res. I, FT1.

### Gear box

**Heating/cooling:** ÖLFLEX® series  
**Cooling fluid pressure gauge:** UNITRONIC® series  
**Sensors PT 100:** UNITRONIC® series  
**Signals (Gear box to Top box):** UNITRONIC® series  
**Temperature bearings:** UNITRONIC® series  
**Cable glands:** SKINTOP® series

### Slip ring – Hub box connection

**Supply drives/control:** ÖLFLEX® series  
**Batteries supply:** ÖLFLEX® series  
**Signals:** ÖLFLEX® series  
**CAN-Bus:** UNITRONIC® Bus-CAN  
**Ethernet:** ETHERLINE® series  
**Heating:** ÖLFLEX® series  
**Cable glands:** SKINTOP® series  
**Plug & Play:** EPIC® connectors round & rectangular – modular

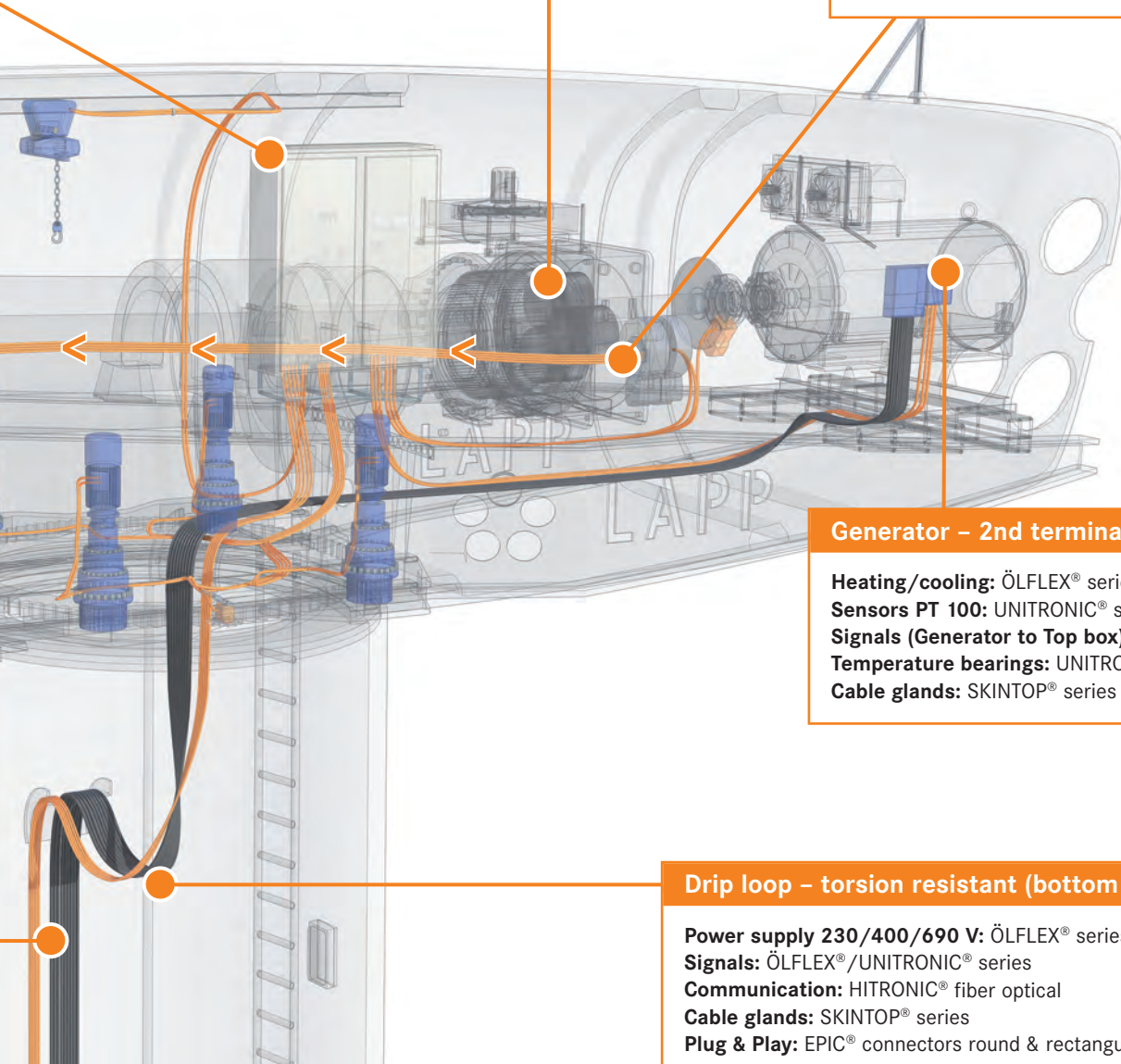

### Generator – 2nd terminal box

**Heating/cooling:** ÖLFLEX® series  
**Sensors PT 100:** UNITRONIC® series  
**Signals (Generator to Top box):** UNITRONIC® series  
**Temperature bearings:** UNITRONIC® series  
**Cable glands:** SKINTOP® series

### Drip loop – torsion resistant (bottom to Top box)

**Power supply 230/400/690 V:** ÖLFLEX® series  
**Signals:** ÖLFLEX® / UNITRONIC® series  
**Communication:** HITRONIC® fiber optical  
**Cable glands:** SKINTOP® series  
**Plug & Play:** EPIC® connectors round & rectangular – modular

Product	Properties
UNITRONIC® BUS	DeviceNet™, Profibus, CAN BUS.
SKINTOP®	IP 68, built-in anti-vibration locking feature, -40 °C metric thread.
EPIC® Rectangular	Rectangular connectors, standard and modular systems.
EPIC® Circular	Industrial grade DIN or MIL* style connectors.
EPIC® Pin & Sleeve	IEC 60309 connector.

\* Please notice that these product are available though Lapp USA. For detailed information see [www.lappusa.com](http://www.lappusa.com).

## From the bottom to the top – all supplied by Lapp



Photo: PowerWind GmbH/J. Meier



Photo: PowerWind GmbH/J. Meier

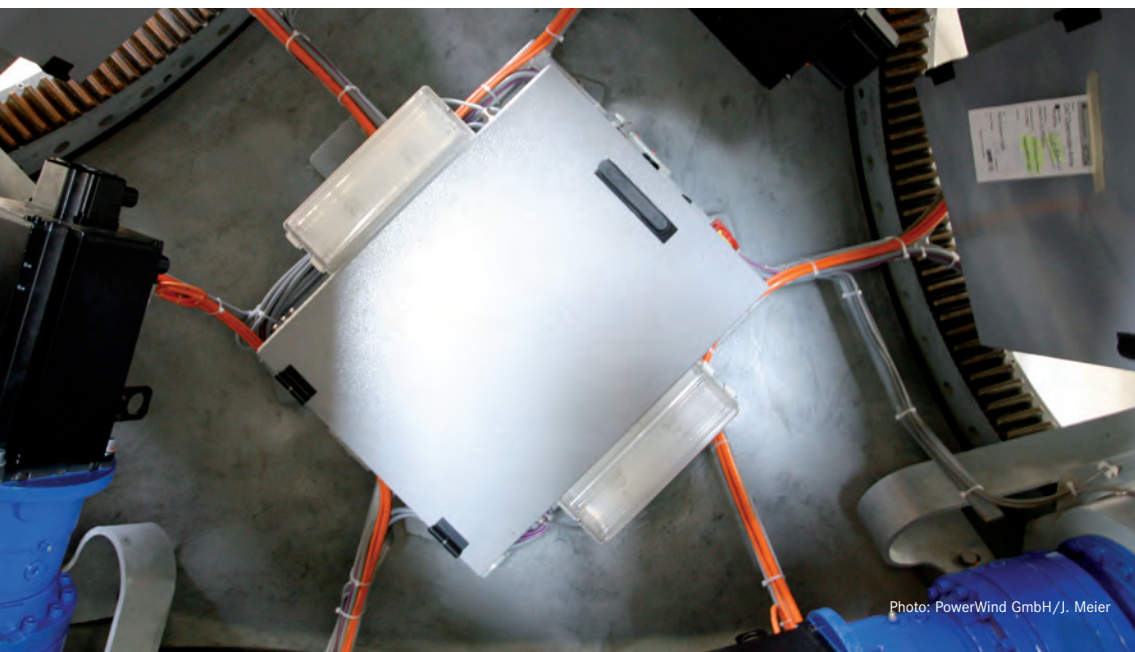

Photo: PowerWind GmbH/J. Meier









Usage criteria		Additional technical information																					
Page		73	74	75	76	77	78	79	80	81	81	82	83	84	85	86	88	89	90	91	92	93	*1
Use		UNITRONIC® DeviceNet THICK + THIN	UNITRONIC® DeviceNet FD THICK + THIN	UNITRONIC® BUS CAN FD P	S/A cable: shielded, M12 socket on free conductor end	S/A cable: 3-pos., valve connector on free conductor end	DeviceNet/CANopen Cable, M12 connector on free conductor end	S/A DeviceNet/CANopen cable, M12 connector on M12 socket	UNITRONIC® BUS PB 105 plus 1x2x0,64	ETHERLINE® Cat.5e 105 plus 2x2xAWG22/7	ETHERLINE® Cat. 5e	ETHERLINE® Cat. 5e Flex	ETHERLINE® Cat. 5e FD & ETHERLINE® Cat. 5 FD BK	UNITRONIC® LAN 200 CAT.5e	UNITRONIC® LAN 250 CAT.6	UNITRONIC® LAN 1200 S/FTP CAT.7a & UNITRONIC® LAN 1500 S/FTP CAT.7a	HITRONIC® Torsion (For the Drip Loop)	HITRONIC® BUS PCF DUPLEX Indoor + Outdoor	HITRONIC® HON Outdoor Cable	HITRONIC® HVN Outdoor Cable	HITRONIC® Duplex Jumper/Patch cable	HITRONIC® Simplex Pigtail	EPIC® Industrial connectors (Rectangular connectors)
Torsion: 5.000 cycles up to -20 °C																							
Torsion: 5.000 cycles up to -40 °C																							
Torsion ±150 °/m																							
Fixed installation		✓	✓	✓	✓	✓	✓	✓	✓	✓	✓	✓	✓	✓	✓	✓	✓	✓	✓	✓	✓	✓	✓
Occasional flexing			✓	✓	✓	✓	✓	✓			✓	✓	✓	✓	✓	✓	✓	✓	✓	✓	✓	✓	✓
Flexing																							
Temperature range: Installation		During the entire installation, the temperature of the cable should not fall below -5 °C.																					
Internal wiring of control cabinets		✓	✓	✓	✓	✓	✓	✓	✓	✓	✓	✓	✓	✓	✓	✓	✓	✓	✓	✓	✓	✓	✓
External wiring of machinery		✓	✓	✓	✓	✓	✓	✓	✓	✓	✓	✓	✓	✓	✓	✓	✓	✓	✓	✓	✓	✓	✓
EMC suitable		✓	✓	✓	✓	✓	✓	✓	✓	✓	✓	✓	✓	✓	✓	✓	✓	✓	✓	✓	✓	✓	✓
Standards																							
Low smoke density acc. IEC 61034																							
Low toxicity of flue gas acc. IEC 60754-2																							
Halogen free acc. to IEC 60754-1		✓			✓	✓	✓	✓			✓	✓		✓	✓		✓		✓			✓	✓
Flame-retardant acc. to IEC 60332-1-2					✓	✓	✓	✓			✓	✓											
No flame-propagation acc. to IEC 60332-3-24																							
No flame-propagation acc. to IEC 60332-3-25																							
FT 1																							
FT 4		✓	✓																				
Flame retardant acc. to UL 1581																							
Flame retardant acc. to UL 94		✓																					
CMG		✓																					
CMX			✓																				
DNV																							
Based on VDE/HAR/DIN																							
VDE registered																							
HAR																							✓
UL/CSA listed cable assembly																							
UL/CSA		✓	✓	✓	✓	✓	✓	✓	✓	✓	✓	✓	✓	✓	✓	✓	✓	✓	✓	✓	✓	✓	✓
Temperature range																							
+180 °C																							
+125 °C																							
+120 °C																							
+105 °C																							
+100 °C																							
+90 °C																							
+80 °C		▲	●	▲	□	□	□	▲	□	□	▲	▲											▲
+75 °C																							
+70 °C																							
+60 °C																							
0 °C																							
-5 °C																							
-10 °C																							
-15 °C																							
-20 °C																							
-25 °C		▲																					
-30 °C			●																				
-35 °C																							
-40 °C			●	▲																			
-50 °C																							
-55 °C																							
Nominal voltage																							
300/500 V acc. to IEC/VDE																							
600 V acc. to UL/CSA																							
450/750 V acc. to IEC/VDE																							
600/1000 V acc. to IEC/VDE																							
1,8/3 kV acc. to IEC																							
1000 V acc. to UL/CSA (AWM)																							
WTTC & TC-ER - Double labeling:																							
WTTC: 1000 V																							
TC-ER: 600 V																							
PLTC 300 V		✓	✓																				
Resistance																							
Oil-resistance		✓	✓	✓					✓	✓			✓	✓	✓								✓
UL OIL RES I																							
UL OIL RES II																							
Salt-water immersion test acc.		✓	✓	✓	✓	✓	✓	✓	✓	✓	✓	✓	✓	✓	✓	✓	✓	✓	✓	✓	✓	✓	✓
UV-resistant		✓	✓	✓	✓	✓	✓	✓	✓	✓	✓	✓	✓	✓	✓	✓	✓	✓	✓	✓	✓	✓	✓
Ozone resistant		✓	✓	✓	✓	✓	✓	✓	✓	✓	✓	✓	✓	✓	✓	✓	✓	✓	✓	✓	✓	✓	✓
Weather-resistant acc. to ISO/EN																							
Protecting rate IP 54																							
Protecting rate IP 64																							
Protecting rate IP 65																							
Protecting rate IP 67																							
Protecting rate IP 68																							
Protecting rate IP 68/69K																							
Protecting rate NEMA 12																							

✓ Main application/design, ✓ Possible application, ● Flexible use, □ Fixed and flexible use, ▲ Fixed installation

E-File Number: see "http://database.ul.com/cgi-bin/XYV/template/LISEXT/1FRAME/index.htm" - Please insert company name "U.I. Lapp" or "Lapp USA". Whilst this information is accurate to the best of our knowledge and experience, it must be treated as a non-binding guideline only. In many cases, tests must be carried out under working conditions to reach a definitive conclusion. Transfer Impedance - On request. \*1 = For current information see: www.lappgroup.com



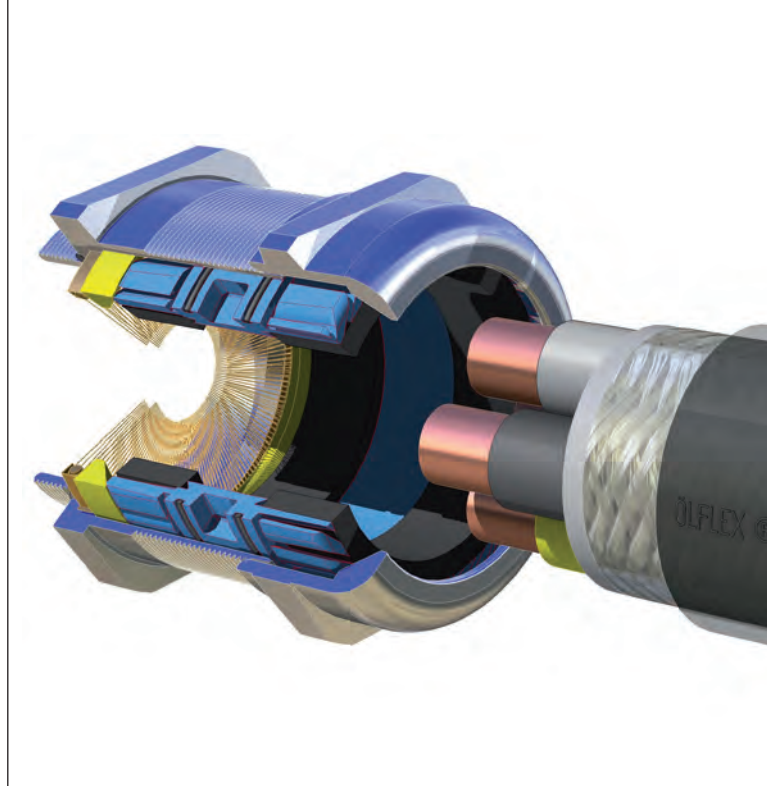

## Temperature ranges for wind turbines

**Important explanations to the use of our temperature ranges in the wind catalogue as well as in our main catalogue. This is how you should understand our cable and cable gland temperature ranges:**

### 1. Cables and wires:

Occasionally flexing or flexing – a seldom occurring situation. WHY? For two reasons:

1.1. Our experience tells us that manufacturing is done inside at temperatures around 20 °C. Repairs in the field seldom below 0 °C.

1.2. The few known applications where we would suggest you use the temperature range for occasionally flexing or flexing are, for example:

#### **Cabinet doors:**

As they are regularly opened and shut over the complete lifetime of the WTG.

#### **Lifts or winches:**

Again, these applications will have reoccurring movement of the cables and should be treated as occasionally flexing or flexing, applying that temperature range.

#### **Fixed installation:**

For all other applications which do not have similar movements, we would recommend you apply the fixed installation temperature range. We estimate this to cover about 98 % of all applications in WTG's as we know them.

1.3. Notice: Sizing of conductor's cross section of cables and wires, used in power circuits, has to be done according to recognised codes of practice. Such codes are typically location-specific national (local) or international standards.

### 2. SKINTOP® cable glands

#### **Temperature range static & dynamic:**

2.1. Temperature range dynamic: occasional bending of the installed cables is possible, as for instance with portable equipment.

2.2. Temperature range static: the installed cables are installed fixed without any mechanical stress.

Our product specialists are at your service should you have any questions regarding specific applications.

**ÖLFLEX® CLASSIC 100**

**Info**

- Up to 5 cores and 1.5 mm<sup>2</sup>: new items with reduced core insulation thickness
- Customised colour option and printing on the outer sheath are available upon request
- Torsion-tested for wind turbines



**Benefits**

- Space-saving installation due to small cable diameters
- High electrical performance due to 4 kV test voltage
- High flexibility due to short-twisted conductor layers

**Application range**

- Heating and cooling systems  
Power supply
- Dry or damp rooms that are subject to medium mechanical loads
- For fixed installation as well as occasional flexing at free, non-continuously recurring movement without tensile load
- Power supply: Drives, slip ring, lights, heater's, cooler's, fan's, lubrication, 24V DC, battery chargers, brakes
- Slip ring - Pitch connection

**Product features**

- Flame-retardant according to IEC 60332-1-2
- Good chemical resistance see Appendix T1

**Approvals**



**Design**

- Fine-wire strand made of bare copper wires
- PVC insulation LAPP P8/1
- Cores twisted in layers
- PVC outer sheath, grey (RAL 7001)

**Technical data**

**Core identification code**  
Up to 5 cores: colour-coded according to VDE 0293-308, refer to Appendix T9  
From 6 cores: ÖLFLEX® colour code, refer to Appendix T7

**Based on**  
IEC 60227-5  
HD 21.5 S3; VDE 0281 Part 5  
HD 21.13 S1; VDE 0281 Part 13

**Specific insulation resistance**  
> 20 GOhm x cm

**Conductor stranding**  
Fine wire according to VDE 0295, class 5/IEC 60228 class 5

**Minimum bending radius**  
Occasional flexing: 15 x outer diameter  
Fixed installation: 4 x outer diameter

**Nominal voltage**  
Up to 1.5 mm<sup>2</sup>: U<sub>0</sub>/U: 300/500 V  
From 2.5 mm<sup>2</sup>: U<sub>0</sub>/U: 450/750 V  
From 2.5 mm<sup>2</sup>, in the case of fixed and protected installations: U<sub>0</sub>/U: 600/1000 V

**Test voltage**  
4000 V

**Protective conductor**  
G = with GN-YE protective conductor  
X = without protective conductor

**Temperature range**  
Occasional flexing: -5°C to +70°C  
Fixed installation: -40°C to +80°C

Article number	Number of cores and mm <sup>2</sup> per conductor	Outer diameter (mm)	Copper index (kg/km)	Weight (kg/km)
<b>ÖLFLEX® CLASSIC 100; U<sub>0</sub>/U: 300/500 V</b>				
0010004	2 X 0.5	4.8	9.6	35
00100014	3 G 0.5	5.1	14.4	42
00101224	3 X 0.5	5.1	14.4	42
00100024	4 G 0.5	5.7	19.2	54
00101234	4 X 0.5	5.7	19.2	54
00100034	5 G 0.5	6.2	24.0	63
00101244	5 X 0.5	6.2	24.0	63
0010004	6 G 0.5	6.7	28.8	73
0010005	7 G 0.5	6.7	33.6	81
0010006	8 G 0.5	8.0	38.4	97
0010007	10 G 0.5	8.6	48.0	116
0010008	12 G 0.5	8.9	58.0	133
0010009	14 G 0.5	9.5	67.0	151
0010010	16 G 0.5	10.0	76.0	169
0010011	21 G 0.5	11.7	99.0	223
0010012	24 G 0.5	12.4	114.0	254
0010016	40 G 0.5	15.4	192.0	404
00100214	2 X 0.75	5.4	14.4	45
00100224	3 G 0.75	5.7	21.6	55
00101254	3 X 0.75	5.7	21.6	55
00100234	4 G 0.75	6.2	28.8	66
00101264	4 X 0.75	6.2	28.8	66
00100244	5 G 0.75	6.7	36.0	79
00101274	5 X 0.75	6.7	36.0	79
0010025	6 G 0.75	7.3	43.3	104
0010026	7 G 0.75	7.3	50.4	109
0010027	8 G 0.75	8.8	56.0	123

Article number	Number of cores and mm <sup>2</sup> per conductor	Outer diameter (mm)	Copper index (kg/km)	Weight (kg/km)
0010028	9 G 0.75	9.4	63.0	144
0010029	10 G 0.75	9.6	72.0	153
0010030	12 G 0.75	9.9	86.4	176
0010031	15 G 0.75	10.9	108.0	211
0010032	18 G 0.75	11.7	129.6	268
0010033	21 G 0.75	13.0	151.0	293
0010034	25 G 0.75	13.8	180.0	374
0010036	40 G 0.75	17.3	288.0	571
0010037	50 G 0.75	19.2	360.0	698
00100414	2 X 1.0	5.7	19.2	53
00100424	3 G 1.0	6.0	28.8	65
00102034	3 X 1.0	6.0	28.8	65
00100434	4 G 1.0	6.5	38.4	79
00102044	4 X 1.0	6.5	38.4	79
00100444	5 G 1.0	7.1	48.0	94
00102054	5 X 1.0	7.1	48.0	94
0010045	6 G 1.0	8.0	58.0	124
0010046	7 G 1.0	8.0	67.0	131
0010047	8 G 1.0	9.5	77.0	146
0010049	10 G 1.0	10.2	96.0	183
0010050	12 G 1.0	10.5	115.0	215
0010052	16 G 1.0	11.8	154.0	282
0010053	18 G 1.0	12.7	173.0	315
0010054	20 G 1.0	13.4	192.0	350
0010056	25 G 1.0	14.7	240.0	449
00100634	2 X 1.5	6.3	28.8	68
00100644	3 G 1.5	6.7	43.2	84
00101284	3 X 1.5	6.7	43.2	84

Various applications

PVC outer sheath and coloured cores

Article number	Number of cores and mm <sup>2</sup> per conductor	Outer diameter (mm)	Copper index (kg/km)	Weight (kg/km)
00100654	4 G 1.5	7.2	57.6	104
00101294	4 X 1.5	7.2	57.6	104
00100664	5 G 1.5	8.1	72.0	128
00101304	5 X 1.5	8.1	72.0	128
0010068	7 G 1.5	8.9	101.0	166
0010069	8 G 1.5	10.6	115.0	205
0010071	12 G 1.5	12.0	173.0	307
0010072	14 G 1.5	12.7	202.0	349
0010074	18 G 1.5	14.4	259.0	465
0010076	25 G 1.5	16.9	360.0	655
<b>ÖLFLEX® CLASSIC 100; U<sub>0</sub>/U: 450/750 V</b>				
0010086	2 X 2.5	8.9	48.0	128
0010087	3 G 2.5	9.6	72.0	162
00100933	3 X 2.5	9.6	72.0	162
00100883	4 G 2.5	10.7	96.0	203
00100893	5 G 2.5	11.8	120.0	242
0010091	7 G 2.5	13.1	168.0	321
0010092	8 G 2.5	15.8	192.0	385
0010100	2 X 4	10.6	76.8	187
0010210	3 G 4	11.4	115.2	244
00101013	4 G 4	12.7	154.0	297
00101023	5 G 4	13.9	192.0	355
0010103	7 G 4	15.4	269.0	471
0010105	3 G 6	12.6	173.0	318
00101063	4 G 6	13.8	230.0	394
00101073	5 G 6	15.6	288.0	489

Article number	Number of cores and mm <sup>2</sup> per conductor	Outer diameter (mm)	Copper index (kg/km)	Weight (kg/km)
0010108	7 G 6	17.3	403.0	651
0010301	3 G 10	15.9	288.0	516
00101093	4 G 10	17.6	384.0	650
00101103	5 G 10	19.7	480.0	792
0010111	7 G 10	21.7	672.0	1058
0010302	3 G 16	18.3	461.0	728
00101123	4 G 16	20.4	614.0	1087
00101133	5 G 16	22.8	768.0	1118
0010303	3 G 25	23.0	720.0	1388
00101153	4 G 25	25.4	960.0	1582
00101163	5 G 25	28.5	1,200.0	1771
0010304	3 G 35	25.6	1,008.0	1766
00101173	4 G 35	28.5	1,344.0	2106
00101183	5 G 35	31.9	1,680.0	2635
0010305	3 G 50	31.0	1,440.0	2556
00101193	4 G 50	34.5	1,920.0	2943
00103133	5 G 50	38.6	2,400.0	3936
0010306	3 G 70	35.3	2,016.0	3182
0010203	4 G 70	39.4	2,688.0	4092
00103143	5 G 70	44.1	3,360.0	4800
0010307	3 G 95	41.3	2,736.0	4675
00101213	4 G 95	45.8	3,648.0	5290
00103153	5 G 95	51.6	4,560.0	5600
0010308	3 G 120	47.6	3,456.0	5626
00103093	4 G 120	53.1	4,608.0	6994
00103123	4 G 185	62.8	7,104.0	8300

Unless specified otherwise, the shown product values are nominal values. Detailed values (e.g. tolerances) are available upon request.  
Copper price basis: EUR 150/100kg. Refer to Appendix T17 for the definition and calculation of copper-related surcharges.

Please find our standard lengths at: [www.lappkabel.de/en/cable-standardlengths](http://www.lappkabel.de/en/cable-standardlengths)

Packaging size: coil ≤ 30 kg or ≤ 250 m, otherwise drum

Please specify the preferred type of packaging (e.g. 1 x 500 m drum or 5 x 100 m coils).

Single lengths for sizes: ≥ 5G50 max. 500 m; ≥ 5G95 max. 400; ≥ 3G120 max. 500 m; ≥ 4G120 max. 300; ≥ 4G185 max. 250 m

Photographs are not to scale and do not represent detailed images of the respective products.

■ Similar products

- UNITRONIC® 100 refer to main catalogue 2012 page 256
- ÖLFLEX® CLASSIC 100 BK POWER 0,6/1kV refer to page 20
- ÖLFLEX® CLASSIC 130 H BK 0,6/1kV refer to main catalogue 2012 page 59

■ Accessories

- SKINTOP® CLICK refer to page 99
- SKINTOP® ST-M refer to page 97
- TY - FAST® standard cable ties refer to page 126
- STAR STRIP stripping tool refer to main catalogue 2012 page 906

ÖLFLEX®

UNITRONIC®

ETHERLINE®

HITRONIC®

EPIC®

SKINTOP®

SILVYN®

FLEXIMARK®

ACCESSORIES

**ÖLFLEX® CLASSIC 100 CY**

**Info**

- EMC-compliant



**Benefits**

- Space-saving installation due to small cable diameters
- High electrical performance due to 4 kV test voltage

**Application range**

- Heating and cooling systems
- Servo drives
- In EMC-sensitive environments (electromagnetic compatibility)
- Power supply: Drives, slip ring, lights, heater's, cooler's, fan's, lubrication, 24V DC, battery chargers, brakes
- Control: Capacitors, sensors

**Product features**

- Flame-retardant according to IEC 60332-1-2
- Good chemical resistance see Appendix T1
- High degree of screening low transfer impedance (max. 250 Ω/km at 30 MHz)

**Approvals**



**Design**

- Fine-wire strand made of bare copper wires
- PVC insulation LAPP P8/1
- PVC inner sheath, grey
- Tinned-copper braiding
- PVC outer sheath, transparent

**Technical data**

**Core identification code**  
Up to 5 cores: colour-coded according to VDE 0293-308, refer to Appendix T9  
From 6 cores: ÖLFLEX® colour code, refer to Appendix T7

**Based on**  
IEC 60227-5  
HD 21.5 S3; VDE 0281 Part 5  
HD 21.13 S1; VDE 0281 Part 13

**Specific insulation resistance**  
> 20 GΩhm x cm

**Conductor stranding**  
Fine wire according to VDE 0295, class 5/IEC 60228 class 5

**Minimum bending radius**  
Occasional flexing: 20 x outer diameter  
Fixed installation: 6 x outer diameter

**Nominal voltage**  
Up to 1.0 mm²: U<sub>0</sub>/U: 300/500 V  
From 1.5 mm²: U<sub>0</sub>/U: 450/750 V  
Fixed, protected installation:  
U<sub>0</sub>/U: 600/1000 V

**Test voltage**  
4000 V

**Protective conductor**  
G = with GN-YE protective conductor  
X = without protective conductor

**Temperature range**  
Occasional flexing: -5°C to +70°C  
Fixed installation: -40°C to +80°C

Article number	Number of cores and mm² per conductor	Outer diameter (mm)	Copper index (kg/km)	Weight (kg/km)
<b>ÖLFLEX® CLASSIC 100 CY; U<sub>0</sub>/U: 300/500 V</b>				
0035001	2 X 0.5	7.0	41.0	75
0035002	3 G 0.5	7.3	46.0	83
0035003	4 G 0.5	7.9	55.0	99
00352013	5 G 0.5	8.4	66.0	112
0035202	7 G 0.5	8.9	80.0	132
0035004	2 X 0.75	7.4	46.0	86
0035005	3 G 0.75	7.9	57.0	100
00350063	4 G 0.75	8.4	64.0	115
00350163	5 G 0.75	8.9	77.0	130
0035203	7 G 0.75	9.7	102.0	161
0035220	2 X 1.0	7.9	56.0	98
0035221	3 G 1.0	8.2	65.0	111
00352223	4 G 1.0	8.7	78.0	130
00352233	5 G 1.0	9.5	89.0	153
0035204	7 G 1.0	10.2	113.0	185
<b>ÖLFLEX® CLASSIC 100 CY; U<sub>0</sub>/U: 450/750 V</b>				
0035000	2 X 1.5	9.9	65.0	132
0035458	3 G 1.5	10.3	79.0	170
00354593	4 G 1.5	11.3	97.0	204
00354603	5 G 1.5	12.6	116.0	246
0035461	7 G 1.5	13.9	149.0	320
0035011	3 G 2.5	11.8	146.0	211
00350173	4 G 2.5	13.5	167.0	310

Article number	Number of cores and mm² per conductor	Outer diameter (mm)	Copper index (kg/km)	Weight (kg/km)
00350123	5 G 2.5	14.6	200.0	326
0035289	7 G 2.5	15.9	288.0	444
00350183	4 G 4	15.1	237.0	403
00350133	5 G 4	16.5	328.0	478
00350193	4 G 6	16.6	318.0	521
00350143	5 G 6	18.2	441.0	624
0034953	3 G 10	18.9	414.0	690
00350213	4 G 10	21.1	558.0	843
00352903	5 G 10	23.1	714.0	1004
0034954	3 G 16	21.7	607.0	910
00350223	4 G 16	23.9	804.0	1164
00350153	5 G 16	26.8	1,050.0	1812
0034955	3 G 25	26.6	936.0	1330
00350233	4 G 25	29.4	1,289.0	1903
00350243	5 G 25	32.6	1,446.0	2374
0034956	3 G 35	29.4	1,258.0	1370
00350253	4 G 35	32.4	1,693.0	2489
00350263	5 G 35	36.0	1,975.0	2771
0034952	3 G 50	35.1	1,748.0	2590
00350273	4 G 50	38.8	2,342.0	3362
00350283	4 G 70	43.7	3,035.0	3719
00350293	4 G 95	50.4	4,055.0	5849
00354303	4 G 120	56.8	5,225.0	7509
00354313	4 G 150	62.2	6,300.0	7800
00354323	4 G 185	67.8	7,753.0	9866

Unless specified otherwise, the shown product values are nominal values. Detailed values (e.g. tolerances) are available upon request.  
Copper price basis: EUR 150/100kg. Refer to Appendix T17 for the definition and calculation of copper-related surcharges.  
Please find our standard lengths at: [www.lappkabel.de/en/cable-standardlengths](http://www.lappkabel.de/en/cable-standardlengths)  
Packaging size: coil ≤ 30 kg or ≤ 250 m, otherwise drum  
Please specify the preferred type of packaging (e.g. 1 x 500 m drum or 5 x 100 m coils).  
Single lengths for sizes: ≥ 4G50 max. 500 m; ≥ 4G95 max. 400 m; ≥ 4G120 max. 300 m; ≥ 4G150 max. 250 m  
Photographs are not to scale and do not represent detailed images of the respective products.

**Similar products**

- ÖLFLEX® CLASSIC 110 CY refer to main catalogue 2012 page 33
- ÖLFLEX® CLASSIC 110 CY BLACK refer to main catalogue 2012 page 36

**Accessories**

- SKINTOP® BRUSH ADD-ON refer to page 106
- SKINTOP® MS-M BRUSH refer to page 105

Various applications

PVC outer sheath and coloured cores

# ÖLFLEX® CLASSIC 100 BK POWER 0,6/1kV



**Info**

- Down to -30°C, also suitable for outdoor use
- UV and weather-resistant according to ISO 4892-2
- Ozone-resistant according to EN 50396
- Torsion-tested for wind turbines

**Benefits**

- High electrical performance due to 4 kV test voltage

**Application range**

- Heating and cooling systems  
Spray-painting lines
- For fixed installation as well as occasional flexing at free, non-continuously recurring movement without tensile load
- Suitable for outdoor applications
- Suitable for direct burial
- Wind vane-, air speed-, air humidity measurement, obstruction light
- Cold environment like hub and blade
- Slip ring – Pitch connection

**Product features**

- Flame-retardant according to IEC 60332-1-2
- UV and weather-resistant according to ISO 4892-2
- Ozone-resistant according to EN 50396
- Flexible down to -30°C

**Approvals**



**Design**

- Fine-wire strand made of bare copper wires
- Core insulation: PVC, cold-resistant
- PVC outer sheath, cold-resistant, black (RAL 9005)

**Technical data**



**Core identification code**  
Up to 5 cores: colour-coded according to VDE 0293-308, refer to Appendix T9  
From 6 cores: ÖLFLEX® colour code, refer to Appendix T7



**Specific insulation resistance**  
> 20 GOhm x cm



**Conductor stranding**  
Fine wire according to VDE 0295, class 5/IEC 60228 class 5



**Minimum bending radius**  
Occasional flexing: 15 x outer diameter  
Fixed installation: 4 x outer diameter



**Nominal voltage**  
U<sub>0</sub>/U: 600/1000 V



**Test voltage**  
4000 V



**Protective conductor**  
G = with GN-YE protective conductor  
X = without protective conductor



**Temperature range**  
Occasional flexing: -30 °C to +70 °C  
Fixed installation: -40°C to +80°C

Article number	Number of cores and mm <sup>2</sup> per conductor	Outer diameter (mm)	Copper index (kg/km)	Weight (kg/km)
<b>ÖLFLEX® CLASSIC 100 BK POWER 0,6/1 kV</b>				
1120456	2 X 1.0	8.6	19.2	98
1120457	3 G 1.0	9.0	29.0	112
1120458	4 G 1.0	9.6	38.0	131
1120459	5 G 1.0	10.4	48.0	152
1120462	2 X 1.5	9.6	29.0	123
1120463	3 G 1.5	10.1	43.0	144
1120464	4 G 1.5	10.8	58.0	170
1120465	5 G 1.5	11.7	72.0	199
1120468	2 X 2.5	10.8	48.0	147
1120469	3 G 2.5	11.3	72.0	182
1120470	4 G 2.5	12.2	96.0	225
1120471	5 G 2.5	13.3	120.0	266
1120474	4 G 4	13.8	154.0	324
1120475	4 G 6	15.1	230.0	442
1120476	4 G 10	18.7	384.0	707
1120477	4 G 16	21.3	614.0	1100
1120478	4 G 25	26.2	960.0	1600
1120479	4 G 35	29.1	1,344.0	2400
1120480	4 G 50	35.6	1,920.0	3400
1120481	4 G 70	40.7	2,688.0	5050
1120482	4 G 95	46.8	3,648.0	6010
1120483	4 G 120	53.5	4,608.0	7500

Unless specified otherwise, the shown product values are nominal values. Detailed values (e.g. tolerances) are available upon request.  
Copper price basis: EUR 150/100kg. Refer to Appendix T17 for the definition and calculation of copper-related surcharges.  
Please find our standard lengths at: [www.lappkabel.de/en/cable-standardlengths](http://www.lappkabel.de/en/cable-standardlengths)  
Packaging size: coil ≤ 30 kg or ≤ 250 m, otherwise drum  
Please specify the preferred type of packaging (e.g. 1 x 500 m drum or 5 x 100 m coils).  
Other sizes and screened types are available upon request.  
Photographs are not to scale and do not represent detailed images of the respective products.

**Similar products**

- ÖLFLEX® CLASSIC 130 H BK 0,6/1kV refer to main catalogue 2012 page 59
- ÖLFLEX® CLASSIC 110 BLACK 0,6/1kV refer to page 25

**Accessories**

- FLEXIMARK® Stainless steel kit refer to main catalogue 2012 page 872
- SKINTOP® MS-M refer to page 102

# ÖLFLEX® CLASSIC 110



**Info**

- VDE certificate of conformity with factory surveillance
- Torsion-tested for wind turbines



**Benefits**

- Space-saving installation due to small cable diameters
- High electrical performance due to 4 kV test voltage

**Application range**

- Heating and cooling systems  
Power supply
- For fixed installation as well as occasional flexing at free, non-continuously recurring movement without tensile load
- Dry or damp rooms that are subject to medium mechanical loads
- Power supply: Drives, slip ring, lights, heater's, cooler's, fan's, lubrication, 24V DC, battery chargers, brakes

**Product features**

- Flame-retardant according to IEC 60332-1-2
- Good chemical resistance  
see main catalogue 2012 Appendix T 1

**Approvals**



**Design**

- Fine-wire strand made of bare copper wires
- PVC insulation LAPP P8/1
- Cores twisted in layers
- PVC outer sheath, grey (RAL 7001)

**Technical data**

- Core identification code**  
Black with white numbers acc. to VDE 0293
- Specific insulation resistance**  
> 20 GOhm x cm
- Conductor stranding**  
Fine wire according to VDE 0295, class 5/IEC 60228 class 5
- Minimum bending radius**  
Occasional flexing: 15 x outer diameter  
Fixed installation: 4 x outer diameter
- Nominal voltage**  
U<sub>0</sub>/U: 300/500 V
- Test voltage**  
4000 V
- Protective conductor**  
G = with GN-YE protective conductor  
X = without protective conductor
- Temperature range**  
Occasional flexing: -15°C to +70°C  
Fixed installation: -40°C to +80°C
- VDE-tested**  
VDE reg. no. 7030 for the following sizes:  
up to 2.5 mm<sup>2</sup>: 2 - 65 cores  
from 4 mm<sup>2</sup>: 2 - 7 cores

Article number	Number of cores and mm <sup>2</sup> per conductor	Standard lengths, metre							Outer diameter (mm)	Copper index (kg/km)	Weight (kg/km)
		25	50	100	200	300	500	1000			
<b>ÖLFLEX® CLASSIC 110</b>											
1119752	2 X0.5			100	200	300	500	1000	4.8	9.6	35
1119003	3 G0.5			100	200	300	500	1000	5.1	14.4	42
1119753	3 X0.5			100	200	300	500	1000	5.1	14.4	42
1119004	4 G0.5			100	200	300	500	1000	5.7	19.2	54
1119754	4 X0.5			100	200	300	500	1000	5.7	19.2	54
1119005	5 G0.5			100	200	300	500	1000	6.2	24.0	63
1119755	5 X0.5			100	200	300	500	1000	6.2	24.0	63
1119007	7 G0.5		50	100	200	300	500	1000	6.7	33.6	81
1119757	7 X0.5		50	100	200	300	500	1000	6.7	33.6	81
1119010	10 G0.5		50	100	200	300	500	1000	8.6	48.0	116
1119012	12 G0.5		50	100	200	300	500	1000	8.9	58.0	131
1119014	14 G0.5		50	100			500	1000	9.5	67.0	153
1119018	18 G0.5		50	100			500	1000	10.5	86.4	188
1119021	21 G0.5		50	100			500	1000	11.7	101.0	221
1119025	25 G0.5		50	100			500	1000	12.4	120.0	261
1119030	30 G0.5		50	100			500	1000	13.3	144.0	304
1119035	35 G0.5		50	100			500	1000	14.5	168.0	356
1119040	40 G0.5		50	100			500	1000	15.4	192.0	400
1119052	52 G0.5		50	100			500		17.3	250.0	517
1119061	61 G0.5		50	100			500		18.5	293.0	603
1119065	65 G0.5		50	100			500		19.6	312.0	644
1119080	80 G0.5		50	100			500		21.1	384.0	780
1119100	100 G0.5		50	100			500		23.6	480.0	975
1119802	2 X0.75			100	200	300	500	1000	5.4	14.4	45
1119103	3 G0.75			100	200	300	500	1000	5.7	21.6	55
1119803	3 X0.75			100	200	300	500	1000	5.7	21.6	55
1119104	4 G0.75			100	200	300	500	1000	6.2	28.8	66
1119804	4 X0.75			100	200	300	500	1000	6.2	28.8	66
1119105	5 G0.75		50	100	200	300	500	1000	6.7	36.0	79
1119805	5 X0.75		50	100	200	300	500	1000	6.7	36.0	79
1119107	7 G0.75		50	100	200	300	500	1000	7.3	50.0	101
1119807	7 X0.75		50	100	200	300	500	1000	7.3	50.0	101
1119109	9 G0.75		50	100	200	300	500	1000	9.4	65.0	137
1119110	10 G0.75		50	100	200	300	500	1000	9.6	72.0	150
1119112	12 G0.75		50	100	200	300	500	1000	9.9	86.0	171
1119812	12 X0.75		50	100	200	300	500	1000	9.9	86.0	171
1119115	15 G0.75		50	100			500	1000	10.9	108.0	209
1119117	15 X0.75		50	100			500	1000	10.9	108.0	209
1119116	16 G0.75		50	100			500	1000	11.1	115.2	220
1119118	18 G0.75		50	100			500	1000	11.7	130.0	244
1119121	21 G0.75		50	100			500	1000	13.0	151.0	286
1119125	25 G0.75		50	100			500	1000	13.8	180.0	337
1119126	26 G0.75		50	100			500	1000	14.2	187.2	350
1119134	34 G0.75		50	100			500	1000	15.9	245.0	448
1119141	41 G0.75		50	100			500	1000	17.4	296.0	538
1119150	50 G0.75		50	100			500		19.2	360.0	648
1119151	51 G0.75		50	100			500		19.2	367.0	646
1119161	61 G0.75		50	100			500		20.5	439.0	779
1119165	65 G0.75		50	100			500		21.8	468.0	832
1119180	80 G0.75		50	100			500		23.6	576.0	1019



Various applications

PVC outer sheath and numbered cores

Article number	Number of cores and mm <sup>2</sup> per conductor	Standard lengths, metre							Outer diameter (mm)	Copper index (kg/km)	Weight (kg/km)
		25	50	100	200	300	500	1000			
1119200	100 G0.75		50	100				500	26.4	718.0	1271
1119852	2 X 1.0			100	200	300		500 1000	5.7	19.2	53
1119203	3 G 1.0			100	200	300		500 1000	6.0	28.8	65
1119853	3 X 1.0			100	200	300		500 1000	6.0	28.8	65
1119204	4 G 1.0		50	100	200	300		500 1000	6.5	38.4	79
1119854	4 X 1.0		50	100	200	300		500 1000	6.5	38.4	79
1119205	5 G 1.0		50	100	200	300		500 1000	7.1	48.0	94
1119855	5 X 1.0		50	100	200	300		500 1000	7.1	48.0	94
1119206	6 G 1.0		50	100	200	300		500 1000	8.0	58.0	113
1119207	7 G 1.0		50	100	200	300		500 1000	8.0	67.0	126
1119857	7 X 1.0		50	100	200	300		500 1000	8.0	67.0	126
1119208	8 G 1.0		50	100	200	300		500 1000	9.5	77.0	149
1119209	9 G 1.0		50	100	200	300		500 1000	10.0	86.0	164
1119210	10 G 1.0		50	100	200	300		500 1000	10.2	96.0	180
1119212	12 G 1.0		50	100	200	300		500 1000	10.5	115.0	205
1119862	12 X 1.0		50	100	200	300		500 1000	10.5	115.0	205
1119214	14 G 1.0		50	100				500 1000	11.2	134.0	238
1119216	16 G 1.0		50	100				500 1000	11.8	153.6	266
1119218	18 G 1.0		50	100				500 1000	12.7	173.0	320
1119868	18 X 1.0		50	100				500 1000	12.7	173.0	320
1119220	20 G 1.0		50	100				500 1000	13.4	192.0	330
1119870	20 X 1.0		50	100				500 1000	13.4	192.0	330
1119225	25 G 1.0		50	100				500 1000	14.7	240.0	408
1119226	26 G 1.0		50	100				500 1000	15.1	249.0	424
1119234	34 G 1.0		50	100				500 1000	17.1	326.0	551
1119236	36 G 1.0		50	100				500 1000	17.4	346.0	578
1119241	41 G 1.0		50	100				500 1000	18.8	394.0	661
1119250	50 G 1.0		50	100				500	20.6	480.0	797
1119256	56 G 1.0		50	100				500	21.4	538.0	888
1119261	61 G 1.0		50	100				500	22.1	586.0	958
1119265	65 G 1.0		50	100				500	23.6	624.0	1033
1119280	80 G 1.0		50	100				500	25.3	768.0	1251
1119300	100 G 1.0		50	100				500	28.3	960.0	1560
1119902	2 X 1.5			100	200	300		500 1000	6.3	29.0	68
1119303	3 G 1.5	25	50	100	200	300		500 1000	6.7	43.0	84
1119903	3 X 1.5		50	100	200	300		500 1000	6.7	43.0	84
1119304	4 G 1.5	25	50	100	200	300		500 1000	7.2	58.0	104
1119904	4 X 1.5		50	100	200	300		500 1000	7.2	58.0	104
1119305	5 G 1.5	25	50	100	200	300		500 1000	8.1	72.0	128
1119905	5 X 1.5		50	100	200	300		500 1000	8.1	72.0	128
1119306	6 G 1.5		50	100	200	300		500 1000	8.4	86.4	157
1119307	7 G 1.5	25	50	100	200	300		500 1000	8.9	101.0	166
1119907	7 X 1.5		50	100	200	300		500 1000	8.9	101.0	166
1119308	8 G 1.5		50	100				500 1000	10.6	115.0	210
1119313	8 X 1.5		50	100				500 1000	10.6	116.0	210
1119309	9 G 1.5		50	100				500 1000	11.4	130.0	221
1119310	10 G 1.5		50	100				500 1000	11.6	143.0	243
1119311	11 G 1.5		50	100				500 1000	11.6	158.0	258
1119312	12 G 1.5	25	50	100				500 1000	12.0	173.0	279
1119912	12 X 1.5		50	100				500 1000	12.0	173.0	279
1119314	14 G 1.5		50	100				500 1000	12.7	202.0	323
1119316	16 G 1.5		50	100				500 1000	13.4	230.4	361
1119318	18 G 1.5	25	50	100				500 1000	14.4	259.0	407
1119321	21 G 1.5		50	100				500 1000	15.7	302.0	469
1119325	25 G 1.5	25	50	100				500 1000	16.9	360.0	560
1119326	26 G 1.5		50	100				500 1000	17.3	374.4	582
1119332	32 G 1.5		50	100				500 1000	18.7	461.0	704
1119334	34 G 1.5		50	100				500 1000	19.4	490.0	746
1119341	41 G 1.5		50	100				500 1000	21.3	591.0	895
1119350	50 G 1.5		50	100				500	23.5	720.0	1089
1119361	61 G 1.5		50	100				500	25.2	878.0	1309
1119365	65 G 1.5		50	100				500	26.7	936.0	1398
1119952	2 X 2.5	25	50	100	200	300		500 1000	7.5	48.0	101
1119403	3 G 2.5	25	50	100	200	300		500 1000	8.1	72.0	132
1119404	4 G 2.5	25	50	100	200	300		500 1000	8.9	96.0	163
1119405	5 G 2.5	25	50	100	200	300		500 1000	10.0	120.0	200
1119407	7 G 2.5	25	50	100				500 1000	11.1	168.0	267
1119412	12 G 2.5	25	50	100				500 1000	14.8	288.0	445
1119414	14 G 2.5		50	100				500 1000	15.8	336.0	515
1119418	18 G 2.5	25	50	100				500 1000	17.8	432.0	648
1119425	25 G 2.5	25	50	100				500 1000	20.8	600.0	890
1119434	34 G 2.5		50	100				500 1000	24.4	816.0	1208
1119450	50 G 2.5		50	100				500	29.4	1,200.0	1754
1119503	3 G 4	25	50	100				500 1000	9.9	115.0	201
1119504	4 G 4	25	50	100				500 1000	10.8	154.0	249
1119505	5 G 4	25	50	100				500 1000	12.1	192.0	294
1119507	7 G 4	25	50	100				500 1000	13.4	269.0	407
1119511	11 G 4		50	100				500 1000	17.6	422.0	634
1119512	12 G 4		50	100				500 1000	18.1	461.0	660
1119603	3 G 6	25	50	100				500 1000	11.7	172.8	289
1119604	4 G 6	25	50	100				500 1000	13.0	230.0	365
1119605	5 G 6	25	50	100				500 1000	14.5	288.0	447
1119607	7 G 6	25	50	100				500 1000	16.0	403.0	600
1119613	3 G 10	25	50	100				500 1000	14.6	288.0	466
1119614	4 G 10	25	50	100				500 1000	16.2	384.0	590
1119615	5 G 10	25	50	100				500 1000	18.1	480.0	722
1119617	7 G 10	25	50	100				500 1000	20.0	672.0	968
1119624	4 G 16		50	100				500	18.8	614.0	1087
1119625	5 G 16		50	100				500	21.2	768.0	1370
1119627	7 G 16		50	100				500	23.4	1,075.0	1779
1119634	4 G 25		50	100				500	23.5	960.0	1582
1119635	5 G 25		50	100				500	26.4	1,200.0	1998
1119636	7 G 25		50	100				500	29.1	1,680.0	2825
1119644	4 G 35		50	100				500	26.4	1,344.0	2106
1119645	5 G 35		50	100				500	29.6	1,680.0	2635

Unless specified otherwise, the shown product values are nominal values. Detailed values (e.g. tolerances) are available upon request.  
 Copper price basis: EUR 150/100kg. Refer to Appendix T17 for the definition and calculation of copper-related surcharges.  
 Packaging size: coil ≤ 30 kg or ≤ 250 m, otherwise drum  
 Please specify the preferred type of packaging (e.g. 1 x 500 m drum or 5 x 100 m coils).  
 Photographs are not to scale and do not represent detailed images of the respective products.

■ Similar products

- ÖLFLEX® 191 refer to page 28

■ Accessories

- SKINTOP® CLICK refer to page 99
- SKINTOP® ST-M refer to page 97

# ÖLFLEX® CLASSIC 110 COLD



**Info**

- VDE certificate of conformity with factory surveillance
- UV and weather-resistant according to ISO 4892-2
- Torsion-tested for wind turbines

**Benefits**

- Space-saving installation due to small cable diameters
- High electrical performance due to 4 kV test voltage

**Application range**

- Plant engineering
- Industrial machinery
- Heating and cooling systems
- Suitable for outdoor applications
- TORSION = ±150°/m
- Wind vane-, air speed-, air humidity measurement, obstruction light
- Cold environment like hub and blade
- Tower and drip loop

LAPP KABEL STUTTGART ÖLFLEX® CLASSIC 110 COLD VDE Reg. Nr. 8274 CE



**Product features**

- Flame-retardant according to IEC 60332-1-2
- Flexible down to -30°C
- UV and weather-resistant according to ISO 4892-2
- Ozone-resistant according to EN 50396
- Torsion-tested for wind turbines

**Approvals**



**Design**

- Fine-wire strand made of bare copper wires
- Core insulation: PVC, cold-resistant
- PVC outer sheath, cold-resistant, grey (RAL 7001)

**Technical data**

- Core identification code**  
Black with white numbers acc. to VDE 0293
- Specific insulation resistance**  
> 20 GOhm x cm
- Conductor stranding**  
Fine wire according to VDE 0295, class 5/IEC 60228 class 5
- Minimum bending radius**  
Occasional flexing: 15 x outer diameter  
Fixed installation: 4 x outer diameter
- Nominal voltage**  
U<sub>0</sub>/U: 300/500 V
- Test voltage**  
4000 V
- Protective conductor**  
G = with GN-YE protective conductor  
X = without protective conductor
- Temperature range**  
Occasional flexing: -30 °C to +70 °C  
Fixed installation: -40°C to +80°C
- VDE-tested**  
VDE reg. no. 8274

Article number	Number of cores and mm <sup>2</sup> per conductor	Outer diameter (mm)	Copper index (kg/km)	Weight (kg/km)
<b>ÖLFLEX® CLASSIC 110 COLD</b>				
1119660	2 X0.75	5.4	14.4	45
1119661	3 X0.75	5.7	21.6	55
1119662	3 G0.75	5.7	21.6	55
1119663	4 X0.75	6.2	28.8	66
1119664	4 G0.75	6.2	28.8	66
1119665	5 X0.75	6.7	36.0	79
1119666	5 G0.75	6.7	36.0	79
1119667	7 X0.75	7.3	50.0	101
1119668	7 G0.75	7.3	50.0	101
1119669	12 G0.75	9.9	86.0	171
1119670	18 G0.75	11.7	130.0	244
1119671	25 G0.75	13.8	180.0	337
1119672	2 X1.0	5.7	19.2	53
1119673	3 X1.0	6.0	28.8	65
1119674	3 G1.0	6.0	28.8	65
1119675	4 X1.0	6.5	38.4	79
1119676	4 G1.0	6.5	38.4	79
1119677	5 X1.0	7.1	48.0	94
1119678	5 G1.0	7.1	48.0	94
1119679	7 X1.0	8.0	67.0	126
1119680	7 G1.0	8.0	67.0	126
1119681	12 G1.0	10.5	115.0	205
1119682	18 G1.0	12.7	173.0	300
1119683	25 G1.0	14.7	240.0	408
1119684	2 X1.5	6.3	29.0	68
1119685	3 X1.5	6.7	43.0	84
1119686	3 G1.5	6.7	43.0	84
1119687	4 X1.5	7.2	58.0	104
1119688	4 G1.5	7.2	58.0	104
1119689	5 X1.5	8.1	72.0	128
1119690	5 G1.5	8.1	72.0	128
1119691	7 X1.5	8.9	101.0	166
1119692	7 G1.5	8.9	101.0	166
1119693	12 G1.5	12.0	173.0	279
1119694	18 G1.5	14.4	259.0	407
1119695	25 G1.5	16.9	360.0	560
1119696	2 X2.5	7.5	48.0	101
1119698	3 G2.5	8.1	72.0	132
1119700	4 G2.5	8.9	96.0	163
1119702	5 G2.5	10.0	120.0	200
1119704	7 G2.5	11.1	168.0	267
1119710	4 G4	10.8	154.0	249
1119711	5 G4	12.1	192.0	305
1119715	4 G6	13.0	230.0	365
1119716	5 G6	14.5	288.0	447

Unless specified otherwise, the shown product values are nominal values. Detailed values (e.g. tolerances) are available upon request.

Copper price basis: EUR 150/100kg. Refer to Appendix T17 for the definition and calculation of copper-related surcharges.

Please find our standard lengths at: [www.lappkabel.de/en/cable-standardlengths](http://www.lappkabel.de/en/cable-standardlengths)

Packaging size: coil ≤ 30 kg or ≤ 250 m, otherwise drum

Please specify the preferred type of packaging (e.g. 1 x 500 m drum or 5 x 100 m coils).

Photographs are not to scale and do not represent detailed images of the respective products.

**Similar products**

- ÖLFLEX® CLASSIC 110 H refer to main catalogue 2012 page 53
- ÖLFLEX® ROBUST 210 refer to main catalogue 2012 page 63

**Accessories**

- FLEXIMARK® Stainless steel kit refer to main catalogue 2012 page 872
- SKINTOP® MS-M refer to page 102

Various applications

PVC outer sheath and numbered cores

# ÖLFLEX® CLASSIC 110 CY



**Info**

- EMC-compliant
- VDE reg. no. 7030

**Benefits**

- Space-saving installation due to small cable diameters
- High electrical performance due to 4 kV test voltage

**Application range**

- Heating and cooling systems
- In EMC-sensitive environments (electromagnetic compatibility)
- Power supply: Drives, slip ring, lights, heater's, cooler's, fan's, lubrication, 24V DC, battery chargers, brakes
- Control: Capacitors, sensors

**Product features**

- Flame-retardant according to IEC 60332-1-2
- Good chemical resistance see Appendix T1
- High degree of screening low transfer impedance (max. 250 Ω/km at 30 MHz)

**Approvals**



**Design**

- Fine-wire strand made of bare copper wires
- PVC insulation LAPP P8/1
- PVC inner sheath, grey
- Tinned-copper braiding
- PVC outer sheath, transparent

**Technical data**

- Core identification code**  
Black with white numbers acc. to VDE 0293
- Specific insulation resistance**  
> 20 GΩhm x cm
- Conductor stranding**  
Fine wire according to VDE 0295, class 5/IEC 60228 class 5
- Minimum bending radius**  
Occasional flexing: 20 x outer diameter  
Fixed installation: 6 x outer diameter
- Nominal voltage**  
U<sub>0</sub>/U: 300/500 V
- Test voltage**  
4000 V
- Protective conductor**  
G = with GN-YE protective conductor  
X = without protective conductor
- Temperature range**  
Occasional flexing: -5 °C to +70 °C  
Fixed installation: -40 °C to +80 °C
- VDE-tested**  
VDE reg. no. 7030 for sizes up to and including 65 cores

Article number	Number of cores and mm <sup>2</sup> per conductor	Outer diameter (mm)	Copper index (kg/km)	Weight (kg/km)
<b>ÖLFLEX® CLASSIC 110 CY</b>				
1135752	2 X0.5	7.0	41.0	75
1135003	3 G0.5	7.3	45.5	83
1135753	3 X0.5	7.3	45.5	83
1135004	4 G0.5	7.9	55.0	99
1135754	4 X0.5	7.9	55.0	99
1135005	5 G0.5	8.4	66.0	112
1135755	5 X0.5	8.4	66.0	112
1135007	7 G0.5	8.9	80.5	132
1135757	7 X0.5	8.9	80.5	132
1135012	12 G0.5	11.3	138.5	202
1135762	12 X0.5	11.3	138.5	202
1135018	18 G0.5	13.3	156.4	289
1135025	25 G0.5	15.2	250.0	378
1135030	30 G0.5	16.1	297.0	429
1135040	40 G0.5	18.2	343.0	542
1135802	2 X0.75	7.4	46.0	86
1135103	3 G0.75	7.9	57.9	100
1135803	3 X0.75	7.9	57.9	100
1135104	4 G0.75	8.4	64.0	115
1135804	4 X0.75	8.4	64.0	115
1135105	5 G0.75	8.9	77.4	130
1135805	5 X0.75	8.9	77.4	130
1135107	7 G0.75	9.7	102.0	161
1135807	7 X0.75	9.7	102.0	161
1135112	12 G0.75	12.3	177.0	247
1135812	12 X0.75	12.3	177.0	247
1135118	18 G0.75	14.5	243.0	356
1135818	18 X0.75	14.5	243.0	356
1135125	25 G0.75	16.6	307.3	465
1135134	34 G0.75	18.9	323.2	601
1135840	40 X0.75	20.5	369.4	734
1135141	41 G0.75	20.6	488.0	728
1135852	2 X1.0	7.9	56.0	98
1135203	3 G1.0	8.2	65.3	111
1135853	3 X1.0	8.2	65.3	111
1135204	4 G1.0	8.7	78.1	130
1135854	4 X1.0	8.7	78.1	130
1135205	5 G1.0	9.5	89.4	153
1135207	7 G1.0	10.2	113.3	185
1135212	12 G1.0	13.3	188.1	307
1135216	16 G1.0	14.6	216.0	390
1135218	18 G1.0	15.5	286.0	418
1135225	25 G1.0	17.5	388.5	544

Article number	Number of cores and mm <sup>2</sup> per conductor	Outer diameter (mm)	Copper index (kg/km)	Weight (kg/km)
1135234	34 G1.0	20.3	505.0	738
1135241	41 G1.0	22.0	578.0	864
1135250	50 G1.0	23.8	688.0	1011
1135902	2 X1.5	8.5	65.0	117
1135303	3 G1.5	8.9	83.0	136
1135903	3 X1.5	8.9	83.0	136
1135304	4 G1.5	9.6	100.0	163
1135904	4 X1.5	9.6	100.0	163
1135305	5 G1.5	10.3	125.0	188
1135905	5 X1.5	10.3	125.0	188
1135307	7 G1.5	11.3	149.0	237
1135907	7 X1.5	11.3	149.0	237
1135312	12 G1.5	14.8	280.0	393
1135318	18 G1.5	17.2	389.0	538
1135325	25 G1.5	20.1	535.0	745
1135334	34 G1.5	22.8	702.0	964
1135341	41 G1.5	24.7	844.6	1123
1135350	50 G1.5	27.1	1,006.0	1372
1135402	2 X2.5	9.9	112.0	165
1135403	3 G2.5	10.3	146.0	192
1135404	4 G2.5	11.3	167.0	233
1135405	5 G2.5	12.6	200.0	283
1135407	7 G2.5	13.9	288.0	371
1135412	12 G2.5	17.6	477.3	585
1135502	2 X4	11.4	120.0	247
1135504	4 G4	13.4	237.0	347
1135505	5 G4	14.7	280.0	413
1135602	2 X6	13.6	180.0	353
1135604	4 G6	15.8	318.0	485
1135605	5 G6	17.3	441.0	702
1135607	7 G6	18.8	530.0	950
1135702	2 X10	16.4	256.0	492
1135615	3 G10	17.4	362.4	507
1135614	4 G10	19.0	558.0	735
1135616	5 G10	21.2	595.0	847
1135617	7 G10	23.2	796.0	1039
1135622	2 X16	18.6	390.0	698
1135624	4 G16	22.2	804.0	1395
1135623	5 G16	26.7	935.0	1440
1135626	4 G25	28.7	1,161.0	1730
1135627	5 G25	31.6	1,400.0	2090
1135625	4 G35	32.0	1,543.0	2210
1135628	5 G35	35.5	1,901.0	2710

Unless specified otherwise, the shown product values are nominal values. Detailed values (e.g. tolerances) are available upon request.  
 Copper price basis: EUR 150/100kg. Refer to Appendix T17 for the definition and calculation of copper-related surcharges.  
 Please find our standard lengths at: [www.lappkabel.de/en/cable-standardlengths](http://www.lappkabel.de/en/cable-standardlengths)  
 Packaging size: coil ≤ 30 kg or ≤ 250 m, otherwise drum  
 Please specify the preferred type of packaging (e.g. 1 x 500 m drum or 5 x 100 m coils).  
 Photographs are not to scale and do not represent detailed images of the respective products.

**Similar products**

- ÖLFLEX® CLASSIC 110 CY BLACK 0,6/1 kV refer to page 26

**Accessories**

- SKINTOP® MS-M BRUSH refer to page 105
- SKINTOP® BRUSH ADD-ON refer to page 106

# ÖLFLEX® CLASSIC 110 BLACK 0,6/1kV



**Info**

- Suitable for outdoor applications
- UV and weather-resistant according to ISO 4892-2
- Ozone-resistant according to EN 50396
- Torsion-tested for wind turbines

**Benefits**

- High electrical performance due to 4 kV test voltage

**Application range**

- Heating and cooling systems  
Power stations
- For fixed installation as well as occasional flexing at free, non-continuously recurring movement without tensile load
- Outdoor use is possible within the indicated operating temperature range
- Suitable for direct burial
- Power supply: Drives, slip ring, lights, heater's, cooler's, fan's, lubrication, 24V DC, battery chargers, brakes
- Wind vane-, air speed-, air humidity measurement, obstruction light
- Slip ring - Pitch connection

**Product features**

- Flame-retardant according to IEC 60332-1-2
- UV and weather-resistant according to ISO 4892-2
- Ozone-resistant according to EN 50396

**Approvals**



**Design**

- Fine-wire strand made of bare copper wires
- PVC insulation LAPP P8/1
- PVC outer sheath, black (RAL 9005)

**Technical data**

- Core identification code**  
Black with white numbers acc. to VDE 0293
- Based on**  
VDE 0250-1 and HD 627 S1
- Specific insulation resistance**  
> 20 GOhm x cm
- Conductor stranding**  
Fine wire according to VDE 0295, class 5/IEC 60228 class 5
- Minimum bending radius**  
Occasional flexing: 15 x outer diameter  
Fixed installation: 4 x outer diameter
- Nominal voltage**  
U<sub>0</sub>/U: 600/1000 V
- Test voltage**  
4000 V
- Protective conductor**  
G = with GN-YE protective conductor  
X = without protective conductor
- Temperature range**  
Occasional flexing: -5°C to +70°C  
Fixed installation: -40°C to +80°C

Article number	Number of cores and mm² per conductor	Outer diameter (mm)	Copper index (kg/km)	Weight (kg/km)
<b>ÖLFLEX® CLASSIC 110 BLACK</b>				
1120232	2 X0.75	8.3	14.4	81
1120233	3 G0.75	8.7	21.6	93
1120234	3 X0.75	8.7	21.6	93
1120235	4 G0.75	9.2	29.0	108
1120237	5 G0.75	9.9	36.0	126
1120241	7 G0.75	10.7	51.0	162
1120248	12 G0.75	13.4	86.0	236
1120251	18 G0.75	15.4	130.0	334
1120259	41 G0.75	21.6	296.0	713
1120266	2 X1.0	8.6	19.2	98
1120267	3 G1.0	9.0	29.0	112
1120268	3 X1.0	9.0	29.0	112
1120269	4 G1.0	9.6	38.4	131
1120270	4 X1.0	9.6	38.4	131
1120271	5 G1.0	10.4	48.0	152
1120274	7 G1.0	11.1	67.0	196
1120280	12 G1.0	14.0	116.0	286
1120284	18 G1.0	16.1	173.0	419
1120290	25 G1.0	18.6	240.0	572
1120294	34 G1.0	21.3	326.0	764
1120298	41 G1.0	23.2	394.0	891
1120306	2 X1.5	9.6	29.0	123
1120307	3 G1.5	10.1	43.0	144
1120308	3 X1.5	10.1	43.0	144
1120309	4 G1.5	10.8	58.0	170
1120311	5 G1.5	11.7	72.0	199
1120314	7 G1.5	12.6	101.0	261
1120320	12 G1.5	16.1	173.0	399
1120322	14 G1.5	17.0	202.0	448
1120324	18 G1.5	18.8	259.0	547

Article number	Number of cores and mm² per conductor	Outer diameter (mm)	Copper index (kg/km)	Weight (kg/km)
1120328	25 G1.5	21.7	360.0	770
1120330	34 G1.5	24.9	490.0	996
1120333	50 G1.5	29.8	720.0	1427
1120339	2 X2.5	10.8	48.0	147
1120340	3 G2.5	11.3	72.0	182
1120342	4 G2.5	12.2	96.0	225
1120343	4 X2.5	12.2	96.0	225
1120344	5 G2.5	13.3	120.0	266
1120346	7 G2.5	14.4	168.0	354
1120349	12 G2.5	18.7	288.0	540
1120350	14 G2.5	19.8	336.0	542
1120351	18 G2.5	22.0	432.0	788
1120353	25 G2.5	25.8	600.0	1094
1120360	4 G4	13.8	154.0	324
1120361	5 G4	15.1	192.0	385
1120362	7 G4	16.4	269.0	513
1120366	4 G6	15.1	230.0	442
1120367	5 G6	16.8	288.0	526
1120368	7 G6	18.2	403.0	705
1120370	4 G10	18.7	384.0	707
1120371	5 G10	20.7	480.0	881
1120374	4 G16	21.3	614.0	1100
1120375	5 G16	23.6	768.0	1600
1120376	7 G16	26.2	1,075.0	1890
1120378	4 G25	26.2	960.0	1600
1120379	5 G25	29.0	1,200.0	2050
1120382	4 G35	29.1	1,344.0	2400
1120383	5 G35	32.5	1,680.0	2900
1120385	4 G50	35.6	1,920.0	3400
1120387	4 G70	40.7	2,688.0	5050
1120389	4 G95	46.8	3,648.0	6010
1120390	4 G120	53.5	4,608.0	7500

Unless specified otherwise, the shown product values are nominal values. Detailed values (e.g. tolerances) are available upon request.  
 Copper price basis: EUR 150/100kg. Refer to Appendix T17 for the definition and calculation of copper-related surcharges.  
 Please find our standard lengths at: [www.lappkabel.de/en/cable-standardlengths](http://www.lappkabel.de/en/cable-standardlengths)  
 Packaging size: coil ≤ 30 kg or ≤ 250 m, otherwise drum  
 Please specify the preferred type of packaging (e.g. 1 x 500 m drum or 5 x 100 m coils).  
 Photographs are not to scale and do not represent detailed images of the respective products.

**Similar products**

- ÖLFLEX® CLASSIC 100 BK POWER 0,6/1kV refer to page 20
- ÖLFLEX® CLASSIC 130 H BK 0,6/1kV refer to main catalogue 2012 page 59

**Accessories**

- SKINTOP® MS-M refer to page 102
- Cable shears KT 4 and KT 5 refer to main catalogue 2012 page 904

Various applications

PVC outer sheath and numbered cores

# ÖLFLEX® CLASSIC 110 CY BLACK 0,6/1 kV

LAPP KABEL STUÏGART ÖLFLEX CLASSIC 110CY Black 0,6/1kV CE



**Info**

- Suitable for outdoor applications
- UV and weather-resistant according to ISO 4892-2
- EMC-compliant

**Benefits**

- High electrical performance due to 4 kV test voltage

**Application range**

- Heating and cooling systems  
Power stations
- For frequency converter-powered 3-phase AC motors
- In EMC-sensitive environments (electromagnetic compatibility)
- For fixed installation as well as occasional flexing at free, non-continuously recurring movement without tensile load
- Outdoor use is possible within the indicated operating temperature range
- Suitable for direct burial
- Power supply: Drives, slip ring, lights, heater's, cooler's, fan's, lubrication, 24V DC, battery chargers, brakes
- Control: Capacitors, sensors
- Wind vane-, air speed-, air humidity measurement, obstruction light
- Slip ring – Pitch connection

**Product features**

- Flame-retardant according to IEC 60332-1-2
- UV and weather-resistant according to ISO 4892-2
- Ozone-resistant according to EN 50396
- High degree of screening  
low transfer impedance  
(max. 250 Ω/km at 30 MHz)

**Approvals**



**Design**

- Fine-wire strand made of bare copper wires
- PVC insulation LAPP P8 / 1
- PVC inner sheath, black
- Tinned-copper braiding
- PVC outer sheath, black (RAL 9005)

**Technical data**

- Core identification code**  
Black with white numbers acc. to VDE 0293
- Based on**  
VDE 0250-1 and HD 627 S 1
- Specific insulation resistance**  
> 20 GΩhm x cm
- Conductor stranding**  
Fine wire according to VDE 0295, class 5/IEC 60228 class 5
- Minimum bending radius**  
Occasional flexing: 20 x outer diameter  
Fixed installation: 6 x outer diameter
- Nominal voltage**  
U<sub>0</sub>/U: 600/1000 V
- Test voltage**  
4000 V
- Protective conductor**  
G = with GN-YE protective conductor  
X = without protective conductor
- Temperature range**  
Occasional flexing: -5°C to +70°C  
Fixed installation: -40°C to +80°C

Article number	Number of cores and mm <sup>2</sup> per conductor	Outer diameter (mm)	Copper index (kg/km)	Weight (kg/km)
<b>ÖLFLEX® CLASSIC 110 CY BLACK</b>				
1121232	2 X0.75	10.5	46.0	183
1121233	3 G0.75	10.9	56.0	210
1121235	4 G0.75	11.4	67.0	238
1121236	4 X0.75	11.4	67.0	238
1121237	5 G0.75	12.1	78.0	272
1121241	7 G0.75	12.9	97.0	315
1121247	12 G0.75	15.8	168.0	464
1121251	18 G0.75	18.0	229.0	616
1121254	25 G0.75	20.7	296.0	762
1121266	2 X1.0	10.8	52.0	198
1121267	3 G1.0	11.2	66.0	228
1121268	3 X1.0	11.2	66.0	228
1121269	4 G1.0	11.8	79.0	261
1121270	4 X1.0	11.8	79.0	261
1121271	5 G1.0	12.6	93.0	300
1121274	7 G1.0	13.3	117.0	335
1121280	12 G1.0	16.4	204.0	522
1121284	18 G1.0	18.7	280.0	687
1121290	25 G1.0	21.6	369.0	884
1121306	2 X1.5	11.8	69.0	243
1121307	3 G1.5	12.3	87.0	273
1121308	3 X1.5	12.3	87.0	273
1121309	4 G1.5	13.0	102.0	290
1121310	4 X1.5	13.0	102.0	290
1121311	5 G1.5	13.9	125.0	352

Article number	Number of cores and mm <sup>2</sup> per conductor	Outer diameter (mm)	Copper index (kg/km)	Weight (kg/km)
1121314	7 G1.5	15.0	180.0	448
1121320	12 G1.5	18.7	281.0	690
1121324	18 G1.5	21.8	391.0	938
1121328	25 G1.5	25.1	518.0	1180
1121340	3 G2.5	13.5	123.0	354
1121342	4 G2.5	14.6	168.0	413
1121344	5 G2.5	15.7	204.0	515
1121346	7 G2.5	17.0	265.0	619
1121349	12 G2.5	21.7	421.0	936
1121360	4 G4	16.2	238.0	587
1121361	5 G4	17.7	302.0	689
1121362	7 G4	19.0	396.0	828
1121367	4 G6	17.7	318.0	715
1121368	5 G6	19.2	419.0	862
1121369	7 G6	21.2	559.0	1105
1121372	4 G10	21.7	574.0	875
1121373	5 G10	23.0	612.0	1037
1121377	4 G16	24.3	809.0	1198
1121378	5 G16	26.7	935.0	1500
1121381	4 G25	29.8	1,165.0	1814
1121382	5 G25	31.6	1,400.0	2164
1121385	4 G35	32.7	1,683.0	2893
1121388	4 G50	39.6	2,368.0	4094
1121391	4 G70	44.5	3,261.0	5467
1121394	4 G95	51.0	4,055.0	5849
1121397	4 G120	58.1	5,225.0	7509

Unless specified otherwise, the shown product values are nominal values. Detailed values (e.g. tolerances) are available upon request.  
 Copper price basis: EUR 150/100kg. Refer to Appendix T17 for the definition and calculation of copper-related surcharges.  
 Please find our standard lengths at: [www.lappkabel.de/en/cable-standardlengths](http://www.lappkabel.de/en/cable-standardlengths)  
 Packaging size: coil ≤ 30 kg or ≤ 250 m, otherwise drum  
 Please specify the preferred type of packaging (e.g. 1 x 500 m drum or 5 x 100 m coils).  
 Photographs are not to scale and do not represent detailed images of the respective products.

**Similar products**

- ÖLFLEX® CLASSIC 135 CH BK 0,6/1kV refer to main catalogue 2012 page 60

**Accessories**

- SKINTOP® MS-M BRUSH refer to page 105
- SKINTOP® BRUSH ADD-ON refer to page 106

**ÖLFLEX® CLASSIC 115 CY**

**Info**

- EMC-compliant
- Thin and light, without inner sheath



**Benefits**

- Space-saving installation due to small cable diameters

**Application range**

- Measurement and control technology
- Power supply: Drives, slip ring, lights, heater's, cooler's, fan's, lubrication, 24V DC, battery chargers, brakes
- Control: Capacitors, sensors

**Product features**

- Flame-retardant according to IEC 60332-1-2
- Good chemical resistance see main catalogue 2012 Appendix T1

**Approvals**



**Design**

- Fine-wire strand made of bare copper wires
- PVC insulation LAPP P8/1
- Plastic foil wrapping
- Tinned-copper braiding
- PVC outer sheath, grey (RAL 7001)

**Technical data**

- Core identification code**  
Black with white numbers acc. to VDE 0293
- Based on**  
HD 21.13 S1; VDE 0281 Part 13
- Specific insulation resistance**  
> 20 GOhm x cm
- Conductor stranding**  
Fine wire according to VDE 0295, class 5/IEC 60228 class 5
- Minimum bending radius**  
Occasional flexing: 20 x outer diameter  
Fixed installation: 6 x outer diameter
- Nominal voltage**  
U<sub>0</sub>/U: 300/500 V
- Test voltage**  
Core/core: 4000 V  
Core/screen: 2000 V
- Protective conductor**  
G = with GN-YE protective conductor  
X = without protective conductor
- Temperature range**  
Occasional flexing: -5°C to +70°C  
Fixed installation: -40°C to +80°C

Article number	Number of cores and mm <sup>2</sup> per conductor	Outer diameter (mm)	Copper index (kg/km)	Weight (kg/km)
<b>ÖLFLEX® CLASSIC 115 CY</b>				
1136752	2 X0.5	5.8	36.0	45
1136003	3 G0.5	6.1	43.0	59
1136753	3 X0.5	6.1	43.0	59
1136004	4 G0.5	6.5	49.0	71
1136754	4 X0.5	6.5	49.0	71
1136005	5 G0.5	7.0	57.0	86
1136755	5 X0.5	7.0	57.0	86
1136007	7 G0.5	7.5	69.0	105
1136757	7 X0.5	7.5	69.0	105
1136012	12 G0.5	9.9	104.0	200
1136762	12 X0.5	9.9	104.0	200
1136018	18 G0.5	11.5	141.0	275
1136768	18 X0.5	11.5	141.0	275
1136025	25 G0.5	13.4	211.0	350
1136775	25 X0.5	13.4	211.0	350
1136802	2 X0.75	6.2	43.0	56
1136103	3 G0.75	6.5	52.0	70
1136803	3 X0.75	6.5	52.0	70
1136104	4 G0.75	7.0	61.0	95
1136804	4 X0.75	7.0	61.0	95
1136105	5 G0.75	7.7	72.0	108
1136805	5 X0.75	7.7	72.0	108
1136107	7 G0.75	8.3	89.0	127
1136807	7 X0.75	8.3	89.0	127
1136112	12 G0.75	10.9	138.0	232
1136118	18 G0.75	12.7	211.0	315
1136125	25 G0.75	14.8	280.0	435
1136825	25 X0.75	14.8	280.0	435
1136852	2 X1.0	6.5	51.0	71
1136203	3 G1.0	6.8	62.0	86
1136853	3 X1.0	6.8	62.0	86
1136204	4 G1.0	7.3	74.0	98
1136854	4 X1.0	7.3	74.0	98
1136205	5 G1.0	8.1	88.0	121
1136855	5 X1.0	8.1	88.0	121

Article number	Number of cores and mm <sup>2</sup> per conductor	Outer diameter (mm)	Copper index (kg/km)	Weight (kg/km)
1136207	7 G1.0	8.8	112.0	147
1136857	7 X1.0	8.8	112.0	147
1136212	12 G1.0	11.5	185.0	285
1136218	18 G1.0	13.9	268.0	395
1136225	25 G1.0	15.9	354.0	486
1136902	2 X1.5	7.1	65.0	86
1136303	3 G1.5	7.5	82.0	112
1136903	3 X1.5	7.5	82.0	112
1136304	4 G1.5	8.2	100.0	135
1136904	4 X1.5	8.2	100.0	135
1136305	5 G1.5	8.9	119.0	148
1136905	5 X1.5	8.9	119.0	148
1136307	7 G1.5	9.9	154.0	192
1136907	7 X1.5	9.9	154.0	192
1136312	12 G1.5	13.0	268.0	365
1136318	18 G1.5	15.6	373.0	520
1136325	25 G1.5	17.9	530.0	734
1136334	34 G1.5	20.8	683.0	944
1136403	3 G2.5	8.9	118.0	151
1136404	4 G2.5	9.9	147.0	188
1136405	5 G2.5	11.0	176.0	270
1136407	7 G2.5	11.9	253.0	340
1136412	12 G2.5	16.0	355.0	540
1136418	18 G2.5	19.0	569.0	782
1136425	25 G2.5	22.2	827.0	1358
1136504	4 G4	11.6	248.0	305
1136507	7 G4	14.4	355.0	500
1136604	4 G6	14.2	343.0	440
1136607	7 G6	17.0	505.0	672
1136614	4 G10	17.2	535.0	680
1136615	5 G10	19.5	592.0	824
1136624	4 G16	20.2	800.0	1050
1136625	5 G16	22.6	895.0	1285
1136634	4 G25	25.1	1,075.0	1413
1136635	5 G25	28.0	1,400.0	1976
1136638	4 G35	28.0	1,576.0	2070

Unless specified otherwise, the shown product values are nominal values. Detailed values (e.g. tolerances) are available upon request.

Copper price basis: EUR 150/100kg. Refer to Appendix T17 for the definition and calculation of copper-related surcharges.

Please find our standard lengths at: [www.lappkabel.de/en/cable-standardlengths](http://www.lappkabel.de/en/cable-standardlengths)

Packaging size: coil ≤ 30 kg or ≤ 250 m, otherwise drum

Please specify the preferred type of packaging (e.g. 1 x 500 m drum or 5 x 100 m coils).

Photographs are not to scale and do not represent detailed images of the respective products.

**Similar products**

- ÖLFLEX® ROBUST 215 C refer to page 35
- ÖLFLEX® CLASSIC 110 CY refer to page 24

**Accessories**

- SKINTOP® BRUSH ADD-ON refer to page 106
- SKINTOP® MS-M BRUSH refer to page 105

# ÖLFLEX® 191

LAPP KABEL STUTTGART ÖLFLEX® 191



**Info**

- Conductor cross-section up to 120 mm<sup>2</sup>
- Oil-resistant according to HD21.1: TM5 and UL 1581 Class 43

**Benefits**

- High electrical performance due to 4 kV test voltage
- For various applications

**Application range**

- Heating and cooling systems
- Mainly used in dry, damp and wet interiors (including water-oil mixtures), but not for outdoor use
- For fixed installation under medium mechanical load conditions, and applications with occasional flexing at free, non-continuously recurring movement without tensile load or compulsory guidance
- Note: for the use of AWM (Appliance Wiring Material) cables in industrial machinery (USA) according to NFPA 79 Ed. 2012: please see the catalogue appendix table T29
- Power supply: Drives, slip ring, lights, heater's, cooler's, fan's, lubrication, 24V DC, battery chargers, brakes
- Slip ring – Pitch connection

**Product features**

- Flame-retardant according to IEC 60332-1-2 and UL 1581 §1061 Cable Flame Test
- Oil-resistant according to HD21.1: TM5 and UL 1581 Class 43

**Approvals**



- Multi-standard cables have conductor strands with nominal sizes in mm<sup>2</sup> or AWG/kcmil. The master size is mentioned in the table below, while the equivalent size of the other system can be found in the Appendix T16 of this catalogue. For this related secondary size the cross-section of the conductor mostly works out to be greater than the specified nominal value.

**Design**

- Fine-wire strand made of bare copper wires
- PVC core insulation
- PVC outer sheath, high oil-resistance, grey (RAL 7001)

**Technical data**

- Core identification code**  
Black with white numbers acc. to VDE 0293
- Approvals**  
UL AWM Style 21098 or 2587  
CSA AWM I A/B II A/B
- Specific insulation resistance**  
> 20 GOhm x cm
- Conductor stranding**  
Fine wire according to VDE 0295, class 5/IEC 60228 class 5
- Minimum bending radius**  
Occasional flexing: 15 x outer diameter  
Fixed installation: 4 x outer diameter
- Nominal voltage**  
HAR U<sub>0</sub>/U: 300/500 V  
UL/CSA: 600 V
- Test voltage**  
4000 V
- Protective conductor**  
G = with GN-YE protective conductor  
X = without protective conductor
- Temperature range**  
Occasional flexing:  
HAR: -5 °C to +70 °C  
UL/CSA: -5 °C to +90 °C  
Fixed installation:  
HAR: -40 °C to +70 °C  
UL/CSA: -40 °C to +90 °C

Article number	Number of cores and mm <sup>2</sup> per conductor	Outer diameter (mm)	Copper index (kg/km)	Weight (kg/km)
<b>ÖLFLEX® 191</b>				
0011106	18 G 0.5	12.1	86.4	267
0011218	2 X 0.75	5.9	14.4	51
0011219	3 G 0.75	6.3	21.6	61
0011220	4 G 0.75	6.8	28.8	74
0011221	5 G 0.75	7.5	36.0	88
0011222	7 G 0.75	8.3	50.4	116
0011223	9 G 0.75	10.5	64.8	152
0011224	12 G 0.75	11.2	86.4	194
0011225	18 G 0.75	13.3	129.6	275
0011226	25 G 0.75	16.1	180.0	383
0011113	3 G 1.0	6.7	28.8	66
0011114	4 G 1.0	7.2	38.4	81
0011115	5 G 1.0	8.1	48.0	95
0011116	7 G 1.0	8.9	67.2	125
0011117	12 G 1.0	12.0	115.2	211
0011118	18 G 1.0	14.4	172.8	309
0011119	25 G 1.0	17.3	240.0	413
0011136	2 X 1.5	6.9	28.8	74
0011137	3 G 1.5	7.3	44.0	91
0011138	4 G 1.5	8.2	58.0	112
0011139	5 G 1.5	9.0	72.0	136
0011140	7 G 1.5	10.0	101.0	179
0011125	9 G 1.5	12.7	129.6	230
0011142	12 G 1.5	13.4	173.0	313

Article number	Number of cores and mm <sup>2</sup> per conductor	Outer diameter (mm)	Copper index (kg/km)	Weight (kg/km)
0011143	18 G 1.5	16.1	260.0	444
0011144	25 G 1.5	19.5	360.0	620
0011150	3 G 2.5	8.4	72.0	138
0011151	4 G 2.5	9.1	96.0	182
0011152	5 G 2.5	10.2	120.0	216
0011153	7 G 2.5	11.4	168.0	286
0011160	3 G 4	10.0	115.2	202
0011161	4 G 4	10.9	154.0	245
0011162	5 G 4	12.2	192.0	310
0011167	7 G 4	13.5	268.8	470
0011165	4 G 6	13.0	231.0	398
0011166	5 G 6	14.5	288.0	479
0011169	4 G 10	16.7	384.0	559
0011170	5 G 10	18.4	480.0	782
0011172	4 G 16	22.1	615.0	904.2
0011173	5 G 16	24.3	768.0	1171
0011175	4 G 25	25.6	960.0	1299
0011176	5 G 25	28.0	1,200.0	1640
0011178	4 G 35	28.1	1,344.0	2119
0011179	5 G 35	31.5	1,680.0	2606
0011205	4 G 50	35.7	1,920.0	2898
0011206	4 G 70	43.0	2,688.0	4052
0011207	4 G 95	47.2	3,648.0	5430
0011208	4 G 120	54.2	4,608.0	6290

Unless specified otherwise, the shown product values are nominal values. Detailed values (e.g. tolerances) are available upon request.

Copper price basis: EUR 150/100kg. Refer to Appendix T17 for the definition and calculation of copper-related surcharges.

Please find our standard lengths at: [www.lappkabel.de/en/cable-standardlengths](http://www.lappkabel.de/en/cable-standardlengths)

Packaging size: coil ≤ 30 kg or ≤ 250 m, otherwise drum

Please specify the preferred type of packaging (e.g. 1 x 600 m drum or 8 x 75 m coils).

Photographs are not to scale and do not represent detailed images of the respective products.

**Similar products**

- ÖLFLEX® 150 QUATTRO refer to main catalogue 2012 page 43
- ÖLFLEX® CONTROL TM refer to page 30
- ÖLFLEX® TRAY II refer to page 32

**Accessories**

- SKINTOP® CLICK refer to page 99
- SKINTOP® ST-M refer to page 97

**ÖLFLEX® 191 CY**



**Info**

- Conductor cross-section up to 120 mm<sup>2</sup>
- Oil-resistant according to HD21.1: TM5 and UL 1581 Class 43
- EMC-compliant

**Benefits**

- High electrical performance due to 4 kV test voltage
- Multifunctional application possibilities

**Application range**

- Heating and cooling systems
- In EMC-sensitive environments (electromagnetic compatibility)
- Mainly used in dry, damp and wet interiors (including water-oil mixtures), but not for outdoor use
- For fixed installation under medium mechanical load conditions, and applications with occasional flexing at free, non-continuously recurring movement without tensile load or compulsory guidance
- Note: for the use of AWM (Appliance Wiring Material) cables in industrial machinery (USA) according to NFPA 79 Ed. 2012: please see the catalogue appendix table T29
- Power supply: Drives, slip ring, lights, heater's, cooler's, fan's, lubrication, 24V DC, battery chargers, brakes
- Control: Capacitors, sensors
- Slip ring – Pitch connection

**Product features**

- Flame-retardant according to IEC 60332-1-2 and UL 1581 §1061 Cable Flame Test
- Oil-resistant according to HD21.1: TM5 and UL 1581 Class 43
- High degree of screening low transfer impedance (max. 250 Ω/km at 30 MHz)

**Approvals**



- Multi-standard cables have conductor strands with nominal sizes in mm<sup>2</sup> or AWG/kcmil. The master size is mentioned in the table below, while the equivalent size of the other system can be found in the Appendix T 16 of this catalogue. For this related secondary size the cross-section of the conductor mostly works out to be greater than the specified nominal value.

**Design**

- Fine-wire strand made of bare copper wires
- PVC core insulation
- PVC inner sheath, grey
- Tinned-copper braiding
- PVC outer sheath, high oil-resistance, grey (RAL 7001)

**Technical data**

- Core identification code**  
Black with white numbers acc. to VDE 0293
- Approvals**  
UL AWM Style 21098 or 2587  
CSA AWM I A/B II A/B
- Specific insulation resistance**  
> 20 GΩhm x cm
- Conductor stranding**  
Fine wire according to VDE 0295, class 5/IEC 60228 class 5
- Minimum bending radius**  
Occasional flexing: 20 x outer diameter  
Fixed installation: 6 x outer diameter
- Nominal voltage**  
HAR U<sub>0</sub>/U: 300/500 V  
UL/CSA: 600 V
- Test voltage**  
4000 V
- Protective conductor**  
G = with GN-YE protective conductor  
X = without protective conductor
- Temperature range**  
Occasional flexing:  
HAR: -5 °C to +70 °C  
UL/CSA: -5 °C to +90 °C  
Fixed installation:  
HAR: -40 °C to +70 °C  
UL/CSA: -40 °C to +90 °C

Article number	Number of cores and mm <sup>2</sup> per conductor	Outer diameter (mm)	Copper index (kg/km)	Weight (kg/km)
<b>ÖLFLEX® 191 CY</b>				
3023436	3 G 0.5	8.0	46.9	122
3025753	4 G 0.5	8.5	47.4	130
0011230	2 X 0.75	8.1	38.4	102
0011231	3 G 0.75	8.5	47.2	115
0011232	4 G 0.75	9.0	55.8	131
0011233	5 G 0.75	9.9	66.4	155
0011234	7 G 0.75	10.5	85.9	187
0011235	12 G 0.75	14.0	145.0	312
0011236	18 G 0.75	16.1	198.3	413
0011237	25 G 0.75	18.9	261.5	548
0011202	2 X 1.0	8.0	48.0	126
0011180	3 G 1.0	8.8	55.8	122
0011181	4 G 1.0	9.6	80.8	157
0011182	5 G 1.0	10.1	89.4	183
0011183	7 G 1.0	10.7	99.9	207
0011184	12 G 1.0	14.6	175.7	342
0011185	18 G 1.0	16.5	241.7	472
0011186	25 G 1.0	19.2	341.7	648
0011302	2 X 1.5	8.9	64.7	156
0011187	3 G 1.5	9.3	89.1	166
0011188	4 G 1.5	10.1	96.6	191
0011189	5 G 1.5	11.0	111.2	222
0011190	7 G 1.5	12.1	145.2	270

Article number	Number of cores and mm <sup>2</sup> per conductor	Outer diameter (mm)	Copper index (kg/km)	Weight (kg/km)
0011191	12 G 1.5	16.0	257.0	464
0011192	18 G 1.5	18.8	382.8	679
0011193	25 G 1.5	22.9	546.2	952
0011194	3 G 2.5	10.9	111.1	221
0011195	4 G 2.5	11.4	140.6	269
0011196	5 G 2.5	12.9	167.3	325
0011197	7 G 2.5	14.1	240.0	421
30010542	12 G 2.5	17.9	414.9	769
30010543	18 G 2.5	22.0	626.1	1102
30010544	4 G 4	13.6	236.7	462
30010545	5 G 4	14.9	277.8	535
30010546	7 G 4	16.2	393.4	735
30010548	4 G 6	15.8	317.1	574
3023130	5 G 6	17.3	413.7	737
30010547	7 G 6	18.8	563.8	950
3023131	4 G 10	19.5	550.4	946
30010639	4 G 16	24.7	819.1	1189
3023132	4 G 25	28.5	1,165.0	1691.67
30010928	4 G 35	31.7	1,683.0	2700
3026535	4 G 50	39.7	2,342.0	3362
3025946	4 G 70	44.8	3,229.0	4490
3025947	4 G 95	50.0	4,010.0	5540
3026536	4 G 120	61.3	5,012.0	6960

Unless specified otherwise, the shown product values are nominal values. Detailed values (e.g. tolerances) are available upon request.  
 Copper price basis: EUR 150/100kg. Refer to Appendix T17 for the definition and calculation of copper-related surcharges.  
 Please find our standard lengths at: [www.lappkabel.de/en/cable-standardlengths](http://www.lappkabel.de/en/cable-standardlengths)  
 Packaging size: coil ≤ 30 kg or ≤ 250 m, otherwise drum  
 Please specify the preferred type of packaging (e.g. 1 x 600 m drum or 8 x 75 m coils).  
 Photographs are not to scale and do not represent detailed images of the respective products.

**Similar products**

- ÖLFLEX® 150 CY QUATTRO refer to main catalogue 2012 page 44
- ÖLFLEX® CONTROL TM CY refer to page 31
- ÖLFLEX® TRAY II CY refer to page 33

**Accessories**

- SKINTOP® MS-SC-M refer to page 104
- SKINTOP® MS-M BRUSH refer to page 105
- SKINTOP® BRUSH ADD-ON refer to page 106



Various applications

PVC sheath, approved

# ÖLFLEX® CONTROL TM



**Info**

- Complies with NFPA 70 and 79 Edition 2012 "Electrical Standard of Industrial Machinery" USA
- Improved oil-resistance: UL OIL RES I & II
- Torsion-tested for wind turbines

**Benefits**

- Wide application range due to multiple approvals
- Cost-saving, easy installation due to omission of closed raceways (suitable for open wiring)

**Application range**

- Machine tools compliant with UL MTW (Machine Tool Wiring)
- TC-ER (Tray Cable Exposed Run) approval for open wiring between cable tray and industrial machines/plants acc. to NEC 336.10(7)
- Wind turbines: USA Wind Turbine Tray Cable (WTTC)
- Class 1, Div. 2 in accordance with NEC "National Electrical Code" Art. 336, 392, 501
- Power supply: Drives, slip ring, lights, heater's, cooler's, fan's, lubrication, 24V DC, battery chargers, brakes
- Tower and drip loop
- Slip ring - Pitch connection

**Product features**

- Flame-retardant according to CSA FT4 UL Vertical-Tray Flame Test
- Oil-resistant according to UL OIL RES I & II
- Water-resistant, UL Wet Approval 75 °C
- Torsion-tested for wind turbines

**Approvals**



- Multi-standard cables have conductor strands with nominal sizes in mm<sup>2</sup> or AWG/kcmil. The master size is mentioned in the table below, while the equivalent size of the other system can be found in the Appendix T16 of this catalogue. For this related secondary size the cross-section of the conductor mostly works out to be greater than the specified nominal value.

**Design**

- Fine-wire strand made of bare copper wires
- Insulation: PVC with nylon sheath (PA skin)
- Outer sheath made of special PVC compound, grey

**Technical data**

- Core identification code**  
Black with white numbers
- Approvals**  
UL MTW, TC-ER, WTTC 1000 V, BUS DROP c(UL) Type TC and CIC FT4  
CSA AWM I/II A/B FT4  
UL AWM Style 20886
- Specific insulation resistance**  
> 20 GOhm x cm
- Conductor stranding**  
Fine-wire, bare copper strand
- Minimum bending radius**  
6 x outer diameter
- Nominal voltage**  
UL/CSA: 600 V (TC, MTW, CIC), WTTC 1000V  
UL/CSA: 1000 V (AWM)  
HAR U<sub>0</sub>/U: 300/500 V
- Test voltage**  
2000 V
- Protective conductor**  
G = with GN-YE protective conductor  
X = without protective conductor
- Temperature range**  
Occasional flexing: -5 °C bis +90 °C  
Fixed installation: -40 °C to +90 °C  
(according to AWM +105 °C)

Article number	Number of cores and mm <sup>2</sup> per conductor	Outer diameter (mm)	Copper index (kg/km)	Weight (kg/km)
<b>ÖLFLEX® CONTROL TM</b>				
281803	3 G 1.0	7.4	28.8	82
281804	4 G 1.0	8.0	38.4	95
281805	5 G 1.0	8.6	48.0	112
281807	7 G 1.0	9.3	67.0	144
281812	12 G 1.0	12.0	115.0	247
281818	18 G 1.0	14.7	173.0	365
281825	25 G 1.0	16.7	240.0	464
281602	2 X 1.5	7.3	28.8	74
281603	3 G 1.5	8.1	43.0	100
281604	4 G 1.5	8.8	58.0	119
281605	5 G 1.5	9.5	72.0	141
281607	7 G 1.5	10.3	101.0	183
281609	9 G 1.5	11.9	129.6	247
281612	12 G 1.5	14.1	173.0	328
281618	18 G 1.5	16.4	259.0	403
281625	25 G 1.5	18.6	360.0	464
281403	3 G 2.5	8.9	72.0	125
281404	4 G 2.5	9.8	96.0	155
281405	5 G 2.5	10.7	120.0	185
281407	7 G 2.5	11.6	168.0	244
281203	3 G 4	10.6	115.0	165
281204	4 G 4	11.5	154.0	220
281205	5 G 4	12.6	192.0	269
281207	7 G 4	14.6	269.0	482
281004	4 G 6	14.5	231.0	382
281005	5 G 6	15.8	288.0	457
280804	4 G 10	17.7	384.0	615
280805	5 G 10	19.4	480.0	771
280604	4 G 16	22.5	615.0	864

Unless specified otherwise, the shown product values are nominal values. Detailed values (e.g. tolerances) are available upon request. Copper price basis: EUR 150/100kg. Refer to Appendix T17 for the definition and calculation of copper-related surcharges. Please find our standard lengths at: [www.lappkabel.de/en/cable-standardlengths](http://www.lappkabel.de/en/cable-standardlengths)  
Packaging size: coil ≤ 30 kg or ≤ 250 m, otherwise drum  
Please specify the preferred type of packaging (e.g. 1 x 610 m drum or 8 x 76 m coils).  
Photographs are not to scale and do not represent detailed images of the respective products.

**Similar products**

- ÖLFLEX® TRAY II refer to page 32
- ÖLFLEX® CONTROL TM CY refer to page 31

**Accessories**

- SKINTOP® MS-M refer to page 102
- SKINTOP® ST-M refer to page 97

**ÖLFLEX® CONTROL TM CY**

**Info**

- Complies with NFPA 70 and 79 Edition 2012 "Electrical Standard of Industrial Machinery" USA
- Improved oil-resistance: UL OIL RES I & II
- Torsion-tested for wind turbines

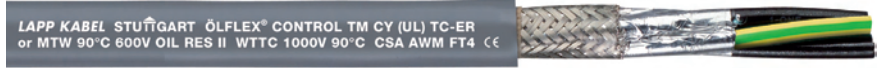

**Benefits**

- Wide application range due to multiple approvals
- Cost-saving, easy installation due to omission of closed raceways (suitable for open wiring)

**Application range**

- Machine tools compliant with UL MTW (Machine Tool Wiring)
- TC-ER (Tray Cable Exposed Run) approval for open wiring between cable tray and industrial machines/plants acc. to NEC 336.10(7)
- Wind turbines: USA Wind Turbine Tray Cable (WTTC)
- Class 1, Div. 2 in accordance with NEC "National Electrical Code" Art. 336, 392, 501
- Power supply: Drives, slip ring, lights, heater's, cooler's, fan's, lubrication, 24V DC, battery chargers, brakes
- Control: Capacitors, sensors
- Tower and drip loop
- Slip ring - Pitch connection

**Product features**

- Flame-retardant according to CSA FT4 UL Vertical-Tray Flame Test
- Oil-resistant according to UL OIL RES I & II
- Water-resistant, UL Wet Approval 75 °C
- High degree of screening low transfer impedance (max. 250 Ω/km at 30 MHz)
- Torsion-tested for wind turbines

**Approvals**



- Multi-standard cables have conductor strands with nominal sizes in mm<sup>2</sup> or AWG/kmil. The master size is mentioned in the table below, while the equivalent size of the other system can be found in the Appendix T16 of this catalogue. For this related secondary size the cross-section of the conductor mostly works out to be greater than the specified nominal value.

**Design**

- Fine-wire strand made of bare copper wires
- Insulation: PVC with nylon sheath (PA skin)
- Aluminum-coated foil
- Tinned-copper braiding
- Outer sheath made of special PVC compound, grey

**Technical data**

- Core identification code**  
Black with white numbers
- Approvals**  
UL MTW, TC-ER, WTTC 1000 V, BUS DROP c(UL) Type TC and CIC FT4  
CSA AWM I/II A/B FT4  
UL AWM Style 20886
- Specific insulation resistance**  
> 20 GOhm x cm
- Conductor stranding**  
Fine-wire, bare copper strand
- Minimum bending radius**  
Fixed installation: 6 x outer diameter
- Nominal voltage**  
UL/CSA: 600 V (TC, MTW, CIC), WTTC 1000V  
UL/CSA: 1000 V (AWM)  
HAR U<sub>0</sub>/U: 300/500 V
- Test voltage**  
2000 V
- Protective conductor**  
G = with GN-YE protective conductor  
X = without protective conductor
- Temperature range**  
Occasional flexing: -5°C bis +90°C  
Fixed installation: -40°C to +90°C (according to AWM +105°C)

Article number	Number of cores and mm <sup>2</sup> per conductor	Outer diameter (mm)	Copper index (kg/km)	Weight (kg/km)
<b>ÖLFLEX® CONTROL TM CY</b>				
281803CY	3 G 1.0	8.1	49.5	119
281804CY	4 G 1.0	8.6	60.2	137
281805CY	5 G 1.0	9.3	81.4	149
281807CY	7 G 1.0	10.0	101.1	193
281812CY	12 G 1.0	12.8	161.4	330
281818CY	18 G 1.0	15.5	228.2	438
281825CY	25 G 1.0	17.5	326.4	574
281602CY	2 X 1.5	8.3	49.7	115
281603CY	3 G 1.5	8.8	65.0	144
281604CY	4 G 1.5	9.4	81.9	173
281605CY	5 G 1.5	10.2	99.1	189
281607CY	7 G 1.5	11.1	140.4	246
281612CY	12 G 1.5	15.0	225.2	426
281618CY	18 G 1.5	17.2	321.7	552
281625CY	25 G 1.5	19.4	453.6	750
281403CY	3 G 2.5	9.7	105.7	180
281404CY	4 G 2.5	10.4	135.6	223
281405CY	5 G 2.5	11.5	160.3	268
281407CY	7 G 2.5	12.4	213.0	327
281204CY	4 G 4	12.3	198.5	315
281205CY	5 G 4	14.2	242.7	388
281207CY	7 G 4	15.3	323.4	499
281004CY	4 G 6	15.3	284.6	552
281005CY	5 G 6	16.7	348.8	613
280804CY	4 G 10	18.5	458.4	857
280604CY	4 G 16	22.9	723.6	1208

Unless specified otherwise, the shown product values are nominal values. Detailed values (e.g. tolerances) are available upon request.  
 Copper price basis: EUR 150/100kg. Refer to Appendix T17 for the definition and calculation of copper-related surcharges.  
 Please find our standard lengths at: [www.lappkabel.de/en/cable-standardlengths](http://www.lappkabel.de/en/cable-standardlengths)  
 Packaging size: coil ≤ 30 kg or ≤ 250 m, otherwise drum  
 Please specify the preferred type of packaging (e.g. 1 x 610 m drum or 8 x 76 m coils).  
 Photographs are not to scale and do not represent detailed images of the respective products.

**Similar products**

- ÖLFLEX® TRAY II CY refer to page 33

**Accessories**

- SKINTOP® MS-SC-M refer to page 104
- SKINTOP® BRUSH ADD-ON refer to page 106

Various applications

PVC sheath, approved

# ÖLFLEX® TRAY II

LAPP KABEL STUTTGART ÖLFLEX® TRAY II-(B) (UL) TC-ER 16 AWG/5C 90 °C DRY 75 °C WET 600 V  
SUN RES DIR BUR or MTW E 171371--c(UL) CIC FT4--CSA AWM II A/B 90C 600V FT4 LL74246 CE



**Info**

- Complies with NFPA 70 and 79 Edition 2012 "Electrical Standard of Industrial Machinery" USA
- Improved oil-resistance: UL OIL RES I & II
- Torsion-tested for wind turbines

**Benefits**

- Wide application range due to multiple approvals
- Cost-saving, easy installation due to omission of closed raceways (suitable for open wiring)

**Application range**

- TC-ER (Tray Cable Exposed Run) approval for open wiring between cable tray and industrial machines/plants acc. to NEC 336.10(7)
- Wind turbines: USA Wind Turbine Tray Cable (WTTC) 1,000 V
- Class 1, Div. 2 in accordance with NEC "National Electrical Code" Art. 336, 392, 501
- Suitable for outdoor use and direct burial
- Power supply: Drives, slip ring, lights, heater's, cooler's, fan's, lubrication, 24V DC, battery chargers, brakes
- Wind vane-, air speed-, air humidity measurement, obstruction light
- Tower and drip loop
- Slip ring - Pitch connection

**Product features**

- Flame-retardant according to CSA FT4 UL Vertical-Tray Flame Test
- Oil-resistant according to UL OIL RES I & II
- Water-resistant, UL Wet Approval 75 °C
- UV-resistant UL SUN RES
- Torsion-tested for wind turbines

**Approvals**



- Multi-standard cables have conductor strands with nominal sizes in mm<sup>2</sup> or AWG/kcmil. The master size is mentioned in the table below, while the equivalent size of the other system can be found in the Appendix T16 of this catalogue. For this related secondary size the cross-section of the conductor mostly works out to be greater than the specified nominal value.

**Design**

- Fine-wire strand made of bare copper wires
- Insulation: PVC with nylon sheath (PA skin)
- Outer sheath made of special PVC compound, black

**Technical data**

- Core identification code**  
Black with white numbers
- Approvals**  
UL MTW, TC-ER, WTTC 1000 V, BUS DROP c(UL) Type TC and CIC FT4  
CSA AWM I/II A/B FT4
- Specific insulation resistance**  
> 20 GOhm x cm
- Conductor stranding**  
Fine copper wire strands
- Minimum bending radius**  
5 x outer diameter
- Nominal voltage**  
UL/CSA: 600 V (TC, MTW, CIC), WTTC 1000V  
UL/CSA: 1000 V (AWM)  
HAR U<sub>0</sub>/U: 300/500 V
- Test voltage**  
2000 V
- Protective conductor**  
G = with GN-YE protective conductor  
X = without protective conductor
- Temperature range**  
Occasional flexing: -5 °C bis +90 °C  
Fixed installation: -40 °C to +90 °C

Article number	Number of cores and mm <sup>2</sup> per conductor	AWG per conductor	Outer diameter (mm)	Copper index (kg/km)	Weight (kg/km)
<b>ÖLFLEX® Tray II</b>					
221803	3 G 1.0		7.5	28.8	85
221804	4 G 1.0		8.1	38.4	98
221805	5 G 1.0		8.8	48.0	115
221807	7 G 1.0		9.5	67.0	149
221809	9 G 1.0		10.9	87.0	167
221812	12 G 1.0		12.1	115.0	255
221818	18 G 1.0		14.9	173.0	365
221825	25 G 1.0		16.9	240.0	479
221603	3 G 1.5		8.3	43.0	103
221604	4 G 1.5		8.9	58.0	124
221605	5 G 1.5		9.7	72.0	146
221607	7 G 1.5		10.5	101.0	189
221608	8 G 1.5		11.3	116.0	203
221609	9 G 1.5		12.1	130.0	255
221612	12 G 1.5		14.4	173.0	328
221618	18 G 1.5		16.6	259.0	431
221625	25 G 1.5		18.8	360.0	592
221641	41 G 1.5		25.0	591.0	931
221650	50 G 1.5		26.6	720.0	1132
221403	3 G 2.5		9.2	72.0	130
221404	4 G 2.5		10.0	96.0	159
221405	5 G 2.5		10.8	120.0	191
221407	7 G 2.5		11.8	168.0	252
221409	9 G 2.5		14.5	216.0	335
221412	12 G 2.5		16.2	288.0	459
221418	18 G 2.5		18.7	432.0	654
221425	25 G 2.5		22.5	600.0	874
221204	4 G 4		11.7	153.0	226
221205	5 G 4		12.8	192.0	279
221207	7 G 4		14.8	269.0	384
221004	4 G 6		14.7	231.0	394
221005	5 G 6		16.0	288.0	472
221007	7 G 6		17.4	405.0	661
220804	4 G 10		17.9	384.0	615
220805	5 G 10		19.6	480.0	771
220604	4 G 16		22.8	615.0	864
220605	5 G 16		24.9	768.0	1080
220404	4 G	4	27.8	960.0	1418
220204	4 G	2	32.3	1,344.0	2077

Unless specified otherwise, the shown product values are nominal values. Detailed values (e.g. tolerances) are available upon request.  
Copper price basis: EUR 150/100kg. Refer to Appendix T17 for the definition and calculation of copper-related surcharges.  
Please find our standard lengths at: [www.lappkabel.de/en/cable-standardlengths](http://www.lappkabel.de/en/cable-standardlengths)  
Packaging size: coil ≤ 30 kg or ≤ 250 m, otherwise drum  
Please specify the preferred type of packaging (e.g. 1 x 610 m drum or 8 x 76 m coils).  
Photographs are not to scale and do not represent detailed images of the respective products.

**Similar products**

- ÖLFLEX® CONTROL TM refer to page 30

**Accessories**

- SKINTOP® MS-M refer to page 102
- SKINTOP® ST-M refer to page 97

**ÖLFLEX® TRAY II CY**



**Info**

- Complies with NFPA 70 and 79 Edition 2012 "Electrical Standard of Industrial Machinery" USA
- Improved oil-resistance: UL OIL RES I & II
- Torsion-tested for wind turbines

LAPP KABEL STUTTGART ÖLFLEX® TRAY II CY (B) (UL) TC-ER 16 AWG/5C 90 °C DRY 75 °C WET 600 V SUN RES DIR BUR or MTW E 171371--c(UL) CIC FT4--CSA AWM II A/B 90C 600V FT4 LL74246 CE



**Benefits**

- Wide application range due to multiple approvals
- Cost-saving, easy installation due to omission of closed raceways (suitable for open wiring)

**Application range**

- TC-ER (Tray Cable Exposed Run) approval for open wiring between cable tray and industrial machines/plants acc. to NEC 336.10(7)
- Wind turbines: USA Wind Turbine Tray Cable (WTTC)
- Class 1, Div. 2 in accordance with NEC "National Electrical Code" Art. 336, 392, 501
- Suitable for outdoor use and direct burial
- Power supply: Drives, slip ring, lights, heater's, cooler's, fan's, lubrication, 24V DC, battery chargers, brakes
- Control: Capacitors, sensors
- Wind vane-, air speed-, air humidity measurement, obstruction light
- Tower and drip loop
- Slip ring - Pitch connection

**Product features**

- Flame-retardant according to CSA FT4 UL Vertical-Tray Flame Test
- Oil-resistant according to UL OIL RES I & II

- Water-resistant, UL Wet Approval 75 °C
- UV-resistant UL SUN RES
- Torsion-tested for wind turbines

**Approvals**



- Multi-standard cables have conductor strands with nominal sizes in mm<sup>2</sup> or AWG/kcmil. The master size is mentioned in the table below, while the equivalent size of the other system can be found in the Appendix T 16 of this catalogue. For this related secondary size the cross-section of the conductor mostly works out to be greater than the specified nominal value.

**Design**

- Fine-wire strand made of bare copper wires
- Insulation: PVC with nylon sheath (PA skin)
- Aluminum-coated foil
- Tinned-copper braiding
- Outer sheath made of special PVC compound, black

**Technical data**

- Core identification code**  
Black with white numbers
- Approvals**  
UL MTW, TC-ER, WTTC 1000 V, BUS DROP c(UL) Type TC and CIC FT4  
CSA AWM I/II A/B FT4
- Specific insulation resistance**  
> 20 GOhm x cm
- Conductor stranding**  
Fine copper wire strands
- Minimum bending radius**  
5 x outer diameter
- Nominal voltage**  
UL/CSA: 600 V (TC, MTW, CIC), WTTC 1000V  
UL/CSA: 1000 V (AWM)  
HAR U<sub>0</sub> /U: 300/500 V
- Test voltage**  
2000 V
- Protective conductor**  
G = with GN-YE protective conductor  
X = without protective conductor
- Temperature range**  
Occasional flexing: -5°C bis +90°C  
Fixed installation: -40°C to +90°C

Article number	Number of cores and mm <sup>2</sup> per conductor	AWG per conductor	Outer diameter (mm)	Copper index (kg/km)	Weight (kg/km)
<b>ÖLFLEX® Tray II CY</b>					
2218030	3 G 1.0		8.2	35.1	119
2218040	4 G 1.0		8.8	55.2	137
2218050	5 G 1.0		9.4	65.8	149
2218070	7 G 1.0		10.1	86.9	193
2218120	12 G 1.0		12.9	149.3	330
2218180	18 G 1.0		15.7	214.2	438
2218250	25 G 1.0		17.7	354.2	574
2216030	3 G 1.5		8.9	59.8	144
2216040	4 G 1.5		9.6	74.5	173
2216050	5 G 1.5		10.3	93.5	189
2216070	7 G 1.5		11.3	130.5	246
2216120	12 G 1.5		15.1	213.8	426
2216180	18 G 1.5		17.3	312.4	515
2216250	25 G 1.5		19.6	415.6	708
2214030	3 G 2.5		9.8	91.2	180
2214040	4 G 2.5		10.7	125.7	223
2214050	5 G 2.5		11.6	150.1	268
2214070	7 G 2.5		12.5	201.2	327
2214120	12 G 2.5		16.9	333.6	595
2214180	18 G 2.5		19.5	487.6	784
2214250	25 G 2.5		23.3	685.1	1048
2212040	4 G 4		12.5	186.4	315
2212050	5 G 4		14.4	232.6	388
2212070	7 G 4		15.5	310.2	499
2210040	4 G 6		15.5	271.7	552
2210070	7 G 6		18.2	457.4	856
2208040	4 G 10		18.7	438.6	857
2206040	4 G 16		23.3	699.0	1208
2204040	4 G	4	28.6	1,296.8	1982
2202040	4 G	2	33.2	1,899.5	2903

Unless specified otherwise, the shown product values are nominal values. Detailed values (e.g. tolerances) are available upon request.  
Copper price basis: EUR 150/100kg. Refer to Appendix T17 for the definition and calculation of copper-related surcharges.  
Please find our standard lengths at: [www.lappkabel.de/en/cable-standardlengths](http://www.lappkabel.de/en/cable-standardlengths)  
Packaging size: coil ≤ 30 kg or ≤ 250 m, otherwise drum  
Please specify the preferred type of packaging (e.g. 1 x 610 m drum or 8 x 76 m coils).  
Photographs are not to scale and do not represent detailed images of the respective products.

**Similar products**

- ÖLFLEX® CONTROL TM CY refer to page 31

**Accessories**

- SKINTOP® MS-SC-M refer to page 104
- SKINTOP® BRUSH ADD-ON refer to page 106

# Overview of halogen-free cables and cable glands



Here you can see a selection of our halogen-free products. More can be found in our current main catalogue.



ÖLFLEX® CLASSIC 100 H



ÖLFLEX® CLASSIC 110 H

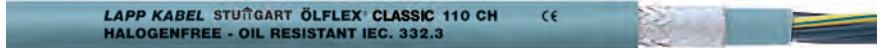

ÖLFLEX® CLASSIC 110 CH



ÖLFLEX® 120 H

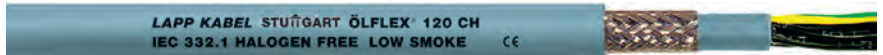

ÖLFLEX® 120 CH



ÖLFLEX® CLASSIC 130 H



ÖLFLEX® CLASSIC 135 CH



ÖLFLEX® CLASSIC 130 H BK 0,6/1kV

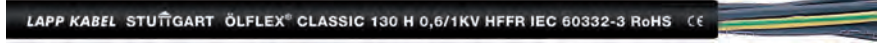

ÖLFLEX® CLASSIC 130 H BK 0,6/1kV



ÖLFLEX® CLASSIC 135 CH BK 0,6/1kV



H07Z-K 90°C

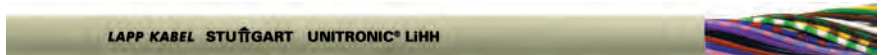

UNITRONIC® LIHH



UNITRONIC® LIHCH

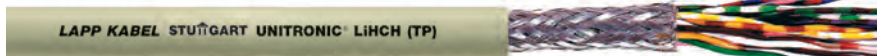

UNITRONIC® LIHCH (TP)



SKINTOP® ST-HF-M

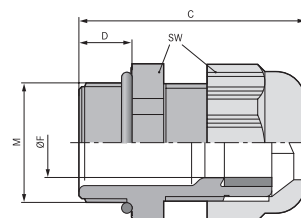

Photographs are not to scale and do not represent detailed images of the respective products.

For current information see: [www.lappgroup.com](http://www.lappgroup.com)

**ÖLFLEX® ROBUST 215 C**

Proven all-weather control cables – resistant to a wide range of chemical media

**Info**

- Excellent weather resistance
- High chemical resistance
- EMC compliant copper screening

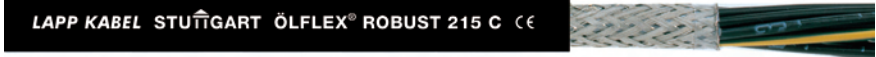

**Benefits**

- Outstanding weather, ozone and UV resistance together with the wide temperature range enable versatile use for both indoor and outdoor applications
- Resistant to contact with plant, animal or synthetic-based organic oils, greases, waxes and the related emulsions
- Good resistance to cold and hot water as well as water-soluble cleaning agents
- Well-suited to frequent steam cleaning

**Application range**

- For indoor and outdoor use
- In EMC-sensitive environments (electromagnetic compatibility)
- Power supply: Drives, slip ring, lights, heater's, cooler's, fan's, lubrication, 24V DC, battery chargers, brakes
- Control: Capacitors, sensors
- Wind vane-, air speed-, air humidity measurement, obstruction light
- Cold environment like hub and blade

**Product features**

- Halogen-free materials
- Good chemical resistance to ester-based hydraulic fluids
- Ozone, UV and weather-resistant according to EN 50396 and HD 605 S2
- Flexible down to -40°C
- Number-coded cores

**Approvals**



**Design**

- Fine-wire strand made of bare copper wires
- Core insulation made of modified PP
- Cores twisted in layers
- Halogen-free plastic foil wrapping
- Tinned copper screen braiding
- Outer sheath made of special TPE
- Sheath colour: black (RAL 9005)

**Technical data**

- Core identification code**  
Black with white numbers acc. to VDE 0293
- Based on**  
VDE 0250/0281
- Conductor stranding**  
Fine wire according to VDE 0295, class 5/IEC 60228 class 5
- Minimum bending radius**  
Occasional flexing: 20 x outer diameter  
Fixed installation: 6 x outer diameter
- Nominal voltage**  
U<sub>0</sub>/U: 300/500 V
- Test voltage**  
Core/core: 4000 V  
Core/screen: 2000 V
- Protective conductor**  
G = with GN-YE protective conductor  
X = without protective conductor
- Temperature range**  
Occasional flexing: -40 °C to +80 °C  
Fixed installation: -50 °C to +80 °C

Article number	Number of cores and mm <sup>2</sup> per conductor	Outer diameter (mm)	Copper index (kg/km)	Weight (kg/km)
<b>ÖLFLEX® ROBUST 215 C</b>				
0022700	2 X 0.5	5.9	36.0	42
0022701	3 G 0.5	6.2	43.0	52
0022702	3 X 0.5	6.2	43.0	52
0022703	4 G 0.5	6.6	49.0	59
0022704	4 X 0.5	6.6	49.0	59
0022705	5 G 0.5	7.1	57.0	68
0022706	5 X 0.5	7.1	57.0	68
0022708	7 G 0.5	7.7	69.0	85
0022709	7 X 0.5	7.7	69.0	85
0022711	12 G 0.5	10.1	104.0	136
0022712	18 G 0.5	11.8	141.0	189
0022713	25 G 0.5	13.7	211.0	265
0022717	2 X 0.75	6.3	43.0	50
0022718	3 G 0.75	6.6	52.0	60
0022719	3 X 0.75	6.6	52.0	60
0022720	4 G 0.75	7.1	61.0	72
0022721	4 X 0.75	7.1	61.0	72
0022722	5 G 0.75	7.9	72.0	88
0022723	5 X 0.75	7.9	72.0	88
0022724	7 G 0.75	8.5	89.0	110
0022725	7 X 0.75	8.5	89.0	110
0022727	12 G 0.75	11.1	138.0	177
0022728	18 G 0.75	13.0	211.0	247
0022729	25 G 0.75	15.1	280.0	347
0022730	34 G 0.75	17.5	380.0	460
0022733	2 X 1.0	6.6	51.0	60
0022734	3 G 1.0	6.9	62.0	70
0022735	3 X 1.0	6.9	62.0	70
0022736	4 G 1.0	7.4	74.0	85

Article number	Number of cores and mm <sup>2</sup> per conductor	Outer diameter (mm)	Copper index (kg/km)	Weight (kg/km)
0022737	4 X 1.0	7.4	74.0	85
0022738	5 G 1.0	8.3	88.0	103
0022739	5 X 1.0	8.3	88.0	103
0022740	7 G 1.0	8.9	112.0	131
0022742	12 G 1.0	11.7	185.0	213
0022743	18 G 1.0	14.1	268.0	321
0022744	25 G 1.0	16.2	354.0	425
0022748	2 X 1.5	7.2	65.0	71
0022749	3 G 1.5	7.6	82.0	90
0022750	3 X 1.5	7.6	82.0	90
0022751	4 G 1.5	8.4	100.0	114
0022752	4 X 1.5	8.4	100.0	114
0022753	5 G 1.5	9.1	119.0	136
0022754	5 X 1.5	9.1	119.0	136
0022756	7 G 1.5	10.0	154.0	177
0022757	7 X 1.5	10.0	154.0	177
0022760	12 G 1.5	13.4	268.0	290
0022761	18 G 1.5	15.8	373.0	435
0022762	25 G 1.5	18.2	530.0	579
0022763	34 G 1.5	21.2	683.0	797
0022767	3 G 2.5	9.1	118.0	134
0022768	4 G 2.5	10.0	147.0	169
0022769	5 G 2.5	11.1	176.0	207
0022770	7 G 2.5	12.0	253.0	270
0022774	4 G 4	11.9	190.0	258
0022776	4 G 6	14.5	290.0	392
0022777	4 G 10	17.5	458.0	602
0022778	4 G 16	20.2	736.6	928
0022771	4 G 25	25.1	1,126.7	1411
0022780	4 G 35	28.0	1,540.0	1883

Unless specified otherwise, the shown product values are nominal values. Detailed values (e.g. tolerances) are available upon request.  
 Copper price basis: EUR 150/100kg. Refer to Appendix T17 for the definition and calculation of copper-related surcharges.  
 Please find our standard lengths at: [www.lappkabel.de/en/cable-standardlengths](http://www.lappkabel.de/en/cable-standardlengths)  
 Packaging size: coil ≤ 30 kg or ≤ 250 m, otherwise drum  
 Please specify the preferred type of packaging (e.g. 1 x 500 m drum or 5 x 100 m coils).  
 Single lengths for sizes: ≥ 4G16 max. 600 m; ≥ 4G25 max. 300 m; ≥ 4G50 max. 250 m  
 Photographs are not to scale and do not represent detailed images of the respective products.

**Similar products**

- ÖLFLEX® CLASSIC 135 CH BK 0,6/1kV refer to main catalogue 2012 page 60

**Accessories**

- SKINTOP® MS-SC-M refer to page 104
- SKINTOP® MS-M BRUSH refer to page 105
- SKINTOP® BRUSH ADD-ON refer to page 106

**Harsh conditions**

High mechanical and chemical resistance

**ÖLFLEX® CLASSIC 400 P**

Abrasion-resistant control cables with PUR sheath for increased application requirements

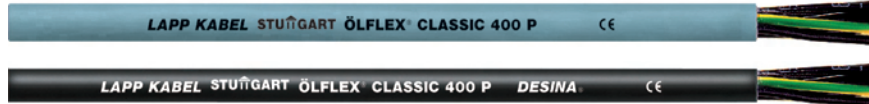

**Info**

- High mechanical strength
- Good oil resistance

**Benefits**

- Increased durability under harsh conditions thanks to robust PUR outer sheath
- Resistant to contact with many mineral oil-based lubricants, diluted acids, aqueous alkaline solutions and other chemical media

**Approvals**



**Design**

- Fine-wire strand made of bare copper wires
- Core insulation: special PVC
- Cores twisted in layers
- Special polyurethane outer sheath (PUR)
- Sheath colour: silver grey (RAL 7001)
- DESINA®-compliant: black (RAL 9005)

**Application range**

- Outdoor use is possible within the indicated operating temperature range
- Power supply: Drives, slip ring, lights, heater's, cooler's, fan's, lubrication, 24V DC, battery chargers, brakes

**Product features**

- High oil-resistance
- Abrasion and notch-resistant
- Low-adhesive surface
- Resistant to hydrolysis and microbes

**Technical data**

- Core identification code**  
Black with white numbers acc. to VDE 0293
- Based on**  
Based on VDE 0281 und 0282
- Conductor stranding**  
Fine wire according to VDE 0295, class 5/IEC 60228 class 5
- Minimum bending radius**  
Flexible use: 12.5 x outer diameter  
Fixed installation: 4 x outer diameter
- Nominal voltage**  
U<sub>0</sub>/U: 300/500 V
- Test voltage**  
4000 V
- Protective conductor**  
G = with GN-YE protective conductor  
X = without protective conductor
- Temperature range**  
Occasional flexing: -5°C to +70°C  
Fixed installation: -40°C to +80°C

Article number	Number of cores and mm <sup>2</sup> per conductor	Outer diameter (mm)	Copper index (kg/km)	Weight (kg/km)
<b>ÖLFLEX® CLASSIC 400 P - sheath colour: grey</b>				
1312802	2 X 0.5	4.8	10.0	32
1312003	3 G 0.5	5.1	15.0	43
1312803	3 X 0.5	5.1	15.0	43
1312004	4 G 0.5	5.7	19.2	50
1312804	4 X 0.5	5.7	19.2	50
1312005	5 G 0.5	6.2	24.0	59
1312805	5 X 0.5	6.2	24.0	59
1312007	7 G 0.5	6.7	34.0	73
1312807	7 X 0.5	6.7	34.0	73
1312010	10 G 0.5	8.6	48.0	109
1312012	12 G 0.5	8.9	57.6	125
1312018	18 G 0.5	10.5	87.0	180
1312025	25 G 0.5	12.4	120.0	250
1312034	34 G 0.5	14.3	164.0	333
1312041	41 G 0.5	15.7	197.0	400
1312852	2 X 0.75	5.4	14.4	41
1312103	3 G 0.75	5.7	21.6	51
1312853	3 X 0.75	5.7	21.6	51
1312104	4 G 0.75	6.2	28.8	62
1312854	4 X 0.75	6.2	28.8	62
1312105	5 G 0.75	6.7	36.0	74
1312855	5 X 0.75	6.7	36.0	74
1312107	7 G 0.75	7.3	50.0	97
1312857	7 X 0.75	7.3	50.0	97
1312110	10 G 0.75	9.6	72.0	142
1312112	12 G 0.75	9.9	86.4	163
1312118	18 G 0.75	11.7	129.6	234
1312125	25 G 0.75	13.8	180.0	324
1312134	34 G 0.75	15.9	244.8	431
1312141	41 G 0.75	17.4	295.2	529
1312902	2 X 1.0	5.7	19.2	48
1312203	3 G 1.0	6.0	28.8	61
1312903	3 X 1.0	6.0	28.8	61
1312204	4 G 1.0	6.5	38.4	74
1312904	4 X 1.0	6.5	38.4	74
1312205	5 G 1.0	7.1	48.0	89
1312905	5 X 1.0	7.1	48.0	89
1312207	7 G 1.0	8.0	67.0	116
1312210	10 G 1.0	10.2	96.0	171
1312212	12 G 1.0	10.5	115.0	197
1312218	18 G 1.0	12.7	173.0	289

Article number	Number of cores and mm <sup>2</sup> per conductor	Outer diameter (mm)	Copper index (kg/km)	Weight (kg/km)
1312225	25 G 1.0	14.7	240.0	412
1312234	34 G 1.0	17.1	326.4	532
1312241	41 G 1.0	18.8	393.6	638
1312952	2 X 1.5	6.3	29.0	63
1312303	3 G 1.5	6.7	43.0	79
1312953	3 X 1.5	6.7	43.0	79
1312304	4 G 1.5	7.2	58.0	98
1312954	4 X 1.5	7.2	58.0	98
1312305	5 G 1.5	8.1	72.0	121
1312955	5 X 1.5	8.1	72.0	121
1312307	7 G 1.5	8.9	101.0	159
1312957	7 X 1.5	8.9	101.0	159
1312312	12 G 1.5	12.0	173.0	268
1312318	18 G 1.5	13.4	259.5	392
1312325	25 G 1.5	16.9	360.0	531
1312334	34 G 1.5	19.4	489.6	722
1312341	41 G 1.5	21.3	590.4	867
1312403	3 G 2.5	8.1	72.0	132
1312404	4 G 2.5	8.9	96.0	163
1312405	5 G 2.5	10.0	120.0	186
1312407	7 G 2.5	11.1	168.0	267
1312412	12 G 2.5	14.8	288.0	445
1312504	4 G 4	10.8	154.0	237
1312505	5 G 4	12.1	192.0	291
1312507	7 G 4	13.4	269.0	391
1312604	4 G 6	13.0	230.4	327
1312605	5 G 6	14.5	288.0	424
1312607	7 G 6	16.0	403.0	580
1312614	4 G 10	16.2	384.0	567
1312615	5 G 10	18.1	480.0	695
1312617	7 G 10	20.0	672.0	937
1312624	4 G 16	18.8	614.4	1064
<b>ÖLFLEX® CLASSIC 400 P DESINA - sheath colour: black</b>				
1312970	4 G 1.5	7.2	58.0	98
1312981	7 G 1.5	8.8	101.0	159
1312983	11 G 1.5	11.6	158.0	228
1312973	4 G 2.5	8.9	96.0	163
1312974	4 G 4	10.8	154.0	237
1312975	4 G 6	13.0	230.4	350
1312976	4 G 10	16.2	384.0	567
1312978	4 G 25	23.5	960.0	1582

Unless specified otherwise, the shown product values are nominal values. Detailed values (e.g. tolerances) are available upon request.  
 Copper price basis: EUR 150/100kg. Refer to Appendix T17 for the definition and calculation of copper-related surcharges.  
 Please find our standard lengths at: [www.lappkabel.de/en/cable-standardlengths](http://www.lappkabel.de/en/cable-standardlengths)  
 Packaging size: coil ≤ 30 kg or ≤ 250 m, otherwise drum  
 Please specify the preferred type of packaging (e.g. 1 x 500 m drum or 5 x 100 m coils).  
 DESINA® is a registered trademark of the German Machine Tool Builders' Association  
 Photographs are not to scale and do not represent detailed images of the respective products.

**Similar products**

- ÖLFLEX® 440 P refer to page 38
- ÖLFLEX® 491 P refer to main catalogue 2012 page 70

**Accessories**

- SKINTOP® ST-M refer to page 97
- SKINTOP® MS-M refer to page 102

**ÖLFLEX® CLASSIC 415 CP**

Abrasion-resistant, screened PUR control cables with reduced outer diameters



**Info**

- Thin and light, without inner sheath
- EMC compliant copper screening

**Benefits**

- Space and weight-saving installations due to small cable diameters
- Increased durability under harsh conditions thanks to robust PUR outer sheath
- Resistant to contact with many mineral oil-based lubricants, diluted acids, aqueous alkaline solutions and other chemical media
- Copper braiding screens the cable against electromagnetic interference

**Application range**

- Very suitable for oily wet areas within machinery and production lines that are subject to normal mechanical stress
- Outdoor use is possible within the indicated operating temperature range
- Power supply: Drives, slip ring, lights, heaters, coolers, fan's, lubrication, 24V DC, battery chargers, brakes
- Control: Capacitors, sensors
- Wind vane-, air speed-, air humidity measurement, obstruction light

**Product features**

- High oil-resistance
- Abrasion and notch-resistant
- EMC-compliant
- Low-adhesive surface
- Resistant to hydrolysis and microbes

**Approvals**



**Design**

- Fine-wire strand made of bare copper wires
- Core insulation: special PVC
- Cores twisted in layers
- Plastic foil wrapping
- Tinned-copper braiding
- Special polyurethane outer sheath (PUR)
- Sheath colour: silver grey (RAL 7001)

**Technical data**

- Core identification code**  
Black with white numbers acc. to VDE 0293
- Based on**  
Core in accordance with VDE 0812/0281  
Outer sheath in accordance with VDE 0250/0282
- Conductor stranding**  
Fine wire according to VDE 0295, class 5/IEC 60228 class 5
- Minimum bending radius**  
Occasional flexing: 20 x outer diameter  
Fixed installation: 6 x outer diameter
- Nominal voltage**  
U<sub>0</sub>/U: 300/500 V
- Test voltage**  
Core/core: 4000 V  
Core/screen: 2000 V
- Protective conductor**  
G = with GN-YE protective conductor  
X = without protective conductor
- Temperature range**  
Occasional flexing: -5°C to +70°C  
Fixed installation: -40°C to +80°C

Article number	Number of cores and mm <sup>2</sup> per conductor	Outer diameter (mm)	Copper index (kg/km)	Weight (kg/km)
<b>ÖLFLEX® CLASSIC 415 CP</b>				
1314000	2 X 0.5	5.8	36.0	45
1314001	3 G 0.5	6.1	43.0	59
1314002	3 X 0.5	6.1	43.0	59
1314003	4 G 0.5	6.5	49.0	83
1314004	4 X 0.5	6.5	49.0	83
1314005	5 G 0.5	7.0	57.0	96
1314006	5 X 0.5	7.0	57.0	96
1314007	7 G 0.5	7.5	69.0	136
1314008	7 X 0.5	7.5	69.0	136
1314010	12 G 0.5	9.9	104.0	200
1314011	12 X 0.5	9.9	104.0	200
1314012	18 G 0.5	11.5	141.0	275
1314013	18 X 0.5	11.5	141.0	275
1314014	25 G 0.5	13.4	211.0	350
1314015	25 X 0.5	13.4	211.0	350
1314017	2 X 0.75	6.2	43.0	56
1314018	3 G 0.75	6.5	52.0	70
1314019	3 X 0.75	6.5	52.0	70
1314020	4 G 0.75	7.0	61.0	95
1314021	4 X 0.75	7.0	61.0	95
1314022	5 G 0.75	7.7	72.0	130
1314023	5 X 0.75	7.7	72.0	130
1314024	7 G 0.75	8.3	89.0	168
1314025	7 X 0.75	8.3	89.0	168
1314026	12 G 0.75	10.9	138.0	232
1314027	18 G 0.75	12.7	211.0	315
1314028	25 G 0.75	14.8	280.0	435
1314029	25 X 0.75	14.8	280.0	435
1314032	2 X 1.0	6.5	51.0	84
1314033	3 G 1.0	6.8	62.0	110
1314034	3 X 1.0	6.8	62.0	110
1314035	4 G 1.0	7.3	74.0	130
1314036	4 X 1.0	7.3	74.0	130
1314037	5 G 1.0	8.1	88.0	156

Article number	Number of cores and mm <sup>2</sup> per conductor	Outer diameter (mm)	Copper index (kg/km)	Weight (kg/km)
1314038	5 X 1.0	8.1	88.0	156
1314039	7 G 1.0	8.8	112.0	192
1314040	7 X 1.0	8.8	112.0	192
1314041	12 G 1.0	11.5	185.0	285
1314042	18 G 1.0	13.9	268.0	395
1314043	25 G 1.0	15.9	354.0	656
1314046	2 X 1.5	7.1	65.0	97
1314047	3 G 1.5	7.5	82.0	125
1314048	3 X 1.5	7.5	82.0	125
1314049	4 G 1.5	8.2	100.0	165
1314050	4 X 1.5	8.2	100.0	165
1314051	5 G 1.5	8.9	119.0	193
1314052	5 X 1.5	8.9	119.0	193
1314053	7 G 1.5	9.9	154.0	245
1314054	7 X 1.5	9.9	154.0	245
1314055	12 G 1.5	13.0	268.0	365
1314056	18 G 1.5	15.6	373.0	553
1314057	25 G 1.5	17.9	530.0	734
1314058	34 G 1.5	20.8	683.0	944
1314061	3 G 2.5	8.9	118.0	188
1314062	4 G 2.5	9.9	147.0	236
1314063	5 G 2.5	11.0	176.0	270
1314064	7 G 2.5	11.9	253.0	340
1314065	12 G 2.5	16.0	355.0	589
1314066	18 G 2.5	19.0	569.0	978
1314067	25 G 2.5	22.2	827.0	1358
1314068	4 G 4	11.6	248.0	305
1314070	7 G 4	14.4	355.0	500
1314071	4 G 6	14.2	343.0	440
1314073	7 G 6	17.0	505.0	672
1314074	4 G 10	17.2	535.0	710
1314075	4 G 16	20.2	800.0	1050
1314076	4 G 25	25.1	1,075.0	1570
1314077	4 G 35	28.0	1,576.0	2070

Unless specified otherwise, the shown product values are nominal values. Detailed values (e.g. tolerances) are available upon request.  
 Copper price basis: EUR 150/100kg. Refer to Appendix T17 for the definition and calculation of copper-related surcharges.  
 Please find our standard lengths at: [www.lappkabel.de/en/cable-standardlengths](http://www.lappkabel.de/en/cable-standardlengths)  
 Packaging size: coil ≤ 30 kg or ≤ 250 m, otherwise drum  
 Please specify the preferred type of packaging (e.g. 1 x 500 m drum or 5 x 100 m coils).  
 Photographs are not to scale and do not represent detailed images of the respective products.

**Similar products**

- ÖLFLEX® ROBUST 215 C refer to page 35
- ÖLFLEX® CLASSIC 400 CP refer to main catalogue 2012 page 66

**Accessories**

- Conductor end sleeves refer to main catalogue 2012 from page 909
- SKINTOP® MS-SC-M refer to page 104



**Harsh conditions**

High mechanical and chemical resistance

**ÖLFLEX® 440 P**

Abrasion-resistant PUR control cables, flexible at cold temperatures – halogen-free and flame-retardant



Info

- Suitable for all weather conditions
- Flexible at low temperatures
- VDE-tested and registered

**Benefits**

- Increased durability under harsh conditions thanks to robust PUR outer sheath
- Resistant to contact with many mineral oil-based lubricants, diluted acids, aqueous alkaline solutions and other chemical media
- Wide temperature range for applications in harsh climatic environments
- Halogen-free insulating material means low corrosive smoke emissions are produced in the event of a fire
- VDE-tested characteristics

**Product features**

- Resistant to oil and drilling fluids according to IEC 61892-4, Appendix D
- Abrasion and notch-resistant
- Halogen-free and flame-retardant (IEC 60332-1-2)
- Resistant to hydrolysis and microbes
- Flexible down to -40°C

**Approvals**



**Application range**

- Very suitable for oily wet areas within machinery that are subject to normal mechanical stress
- For indoor and outdoor use
- Power supply: Drives, slip ring, lights, heater's, cooler's, fan's, lubrication, 24V DC, battery chargers, brakes
- Wind vane-, air speed-, air humidity measurement, obstruction light
- Cold environment like hub and blade
- Slip ring – Pitch connection

**Design**

- Fine-wire, tinned-copper conductor
- Core insulation: TPE
- Cores twisted in layers
- Special polyurethane outer sheath (PUR)
- Sheath colour: silver grey (RAL 7001)

**Technical data**

- Core identification code**  
Black with white numbers acc. to VDE 0293
- Specific insulation resistance**  
> 20 GOhm x cm
- Conductor stranding**  
Fine wire according to VDE 0295, class 5/IEC 60228 class 5
- Minimum bending radius**  
Occasional flexing: 12.5 x outer diameter  
Fixed installation: 4 x outer diameter
- Nominal voltage**  
U<sub>0</sub>/U: 300/500 V
- Test voltage**  
3000 V
- Protective conductor**  
G = with GN-YE protective conductor  
X = without protective conductor
- Temperature range**  
Occasional flexing: -40 °C to +90 °C  
Fixed installation: -50°C to +90°C
- VDE-tested**  
VDE reg. no. 6582  
4 - 6 mm<sup>2</sup>: based on VDE 0281/0282

Article number	Number of cores and mm <sup>2</sup> per conductor	Outer diameter (mm)	Copper index (kg/km)	Weight (kg/km)
<b>ÖLFLEX® 440 P</b>				
0012800	2 X 0.5	5.9	10.0	39
0012801	3 G 0.5	6.2	14.0	46
0012802	4 G 0.5	6.9	19.0	53
0012803	5 G 0.5	7.4	24.0	65
0012804	7 G 0.5	9.1	34.0	92
0012805	12 G 0.5	11.3	58.0	149
0012806	18 G 0.5	13.2	86.0	207
0012807	25 G 0.5	15.0	120.0	274
0012813	2 X 0.75	6.4	14.0	48
0012814	3 G 0.75	6.8	22.0	53
0012815	4 G 0.75	7.4	29.0	67
0012816	5 G 0.75	8.6	36.0	81
0012817	7 G 0.75	10.0	50.0	119
0012818	12 G 0.75	12.4	86.0	193
0012819	18 G 0.75	14.4	130.0	269
0012820	25 G 0.75	17.2	180.0	378
0012825	2 X 1.0	6.8	19.0	57
0012826	3 G 1.0	7.2	29.0	61
0012827	4 G 1.0	8.2	38.0	82

Article number	Number of cores and mm <sup>2</sup> per conductor	Outer diameter (mm)	Copper index (kg/km)	Weight (kg/km)
0012828	5 G 1.0	9.0	48.0	107
0012829	7 G 1.0	11.1	67.0	138
0012830	12 G 1.0	13.2	115.0	215
0012831	18 G 1.0	15.4	173.0	328
0012832	25 G 1.0	19.0	240.0	479
0012833	34 G 1.0	21.8	326.0	616
0012834	41 G 1.0	23.4	394.0	727
0012837	2 X 1.5	7.4	29.0	73
0012838	3 G 1.5	8.3	43.0	96
0012839	4 G 1.5	9.0	58.0	105
0012840	5 G 1.5	9.8	72.0	133
0012841	7 G 1.5	12.2	101.0	175
0012842	12 G 1.5	14.5	173.0	309
0012843	18 G 1.5	17.6	259.0	458
0012844	25 G 1.5	20.7	360.0	635
0012846	41 G 1.5	26.3	590.0	1003
0012850	3 G 2.5	9.7	72.0	142
0012851	4 G 2.5	11.0	96.0	184
0012852	5 G 2.5	12.1	120.0	220
0012853	7 G 2.5	14.2	168.0	294
0012854	12 G 2.5	17.8	288.0	489

Unless specified otherwise, the shown product values are nominal values. Detailed values (e.g. tolerances) are available upon request.  
 Copper price basis: EUR 150/100kg. Refer to Appendix T17 for the definition and calculation of copper-related surcharges.  
 Please find our standard lengths at: [www.lappkabel.de/en/cable-standardlengths](http://www.lappkabel.de/en/cable-standardlengths)  
 Packaging size: coil ≤ 30 kg or ≤ 250 m, otherwise drum  
 Please specify the preferred type of packaging (e.g. 1 x 500 m drum or 5 x 100 m coils).  
 Photographs are not to scale and do not represent detailed images of the respective products.

**Similar products**

- ÖLFLEX® ROBUST 210 refer to main catalogue 2012 page 63
- ÖLFLEX® CLASSIC 400 P refer to page 36
- ÖLFLEX® 491 P refer to main catalogue 2012 page 70

**Accessories**

- SKINTOP® MS-M refer to page 102
- SKINTOP® ST-M refer to page 97

**ÖLFLEX® 440 CP**

**Abrasion-resistant PUR control cables, flexible at cold temperatures – screened, halogen-free and flame-retardant**

**Info**

- Suitable for all weather conditions
- VDE-tested and registered
- EMC compliant copper screening

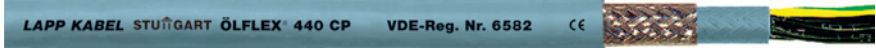

**Benefits**

- Increased durability under harsh conditions thanks to robust PUR outer sheath
- Resistant to contact with many mineral oil-based lubricants, diluted acids, aqueous alkaline solutions and other chemical media
- Wide temperature range for applications in harsh climatic environments
- Halogen-free insulating material means low corrosive smoke emissions are produced in the event of a fire
- Copper braiding screens the cable against electromagnetic interference

**Application range**

- Very suitable for oily wet areas within machinery that are subject to normal mechanical stress
- For indoor and outdoor use
- Power supply: Drives, slip ring, lights, heater's, cooler's, fan's, lubrication, 24V DC, battery chargers, brakes
- Control: Capacitors, sensors
- Wind vane-, air speed-, air humidity measurement, obstruction light
- Cold environment like hub and blade
- Slip ring – Pitch connection

**Product features**

- Resistant to oil and drilling fluids according to IEC 61892-4, Appendix D
- Abrasion and notch-resistant
- Halogen-free and flame-retardant (IEC 60332-1-2)
- Resistant to hydrolysis and microbes
- Flexible at low temperatures

**Approvals**



**Design**

- Fine-wire, tinned-copper conductor
- Core insulation: TPE
- Cores twisted in layers
- Inner sheath made of TPE
- Tinned-copper braiding
- Special polyurethane outer sheath (PUR)
- Sheath colour: silver grey (RAL 7001)

**Technical data**

- Core identification code**  
Black with white numbers acc. to VDE 0293
- Specific insulation resistance**  
> 20 GOhm x cm
- Conductor stranding**  
Fine wire according to VDE 0295, class 5/IEC 60228 class 5
- Minimum bending radius**  
Occasional flexing: 15 x outer diameter  
Fixed installation: 6 x cable diameter
- Nominal voltage**  
U<sub>0</sub>/U: 300/500 V
- Test voltage**  
3000 V
- Protective conductor**  
G = with GN-YE protective conductor  
X = without protective conductor
- Temperature range**  
Occasional flexing: -40 °C to +90 °C  
Fixed installation: -50 °C to +90 °C
- VDE-tested**  
VDE reg. no. 6582  
4 – 6 mm<sup>2</sup>: based on VDE 0281/0282

Article number	Number of cores and mm <sup>2</sup> per conductor	Outer diameter (mm)	Copper index (kg/km)	Weight (kg/km)
<b>ÖLFLEX® 440 CP</b>				
0012901	3 G 0.5	8.3	44.0	100
0012902	4 G 0.5	8.8	52.0	120
0012903	5 G 0.5	9.7	61.0	139
0012904	7 G 0.5	11.2	75.0	175
0012906	12 G 0.5	13.7	131.0	276
0012907	18 G 0.5	15.7	168.0	376
0012908	25 G 0.5	18.5	212.0	485
0012911	2 X 0.75	8.4	45.0	104
0012912	3 G 0.75	8.7	52.0	119
0012913	4 G 0.75	9.5	67.0	126
0012914	5 G 0.75	10.2	75.0	165
0012915	7 G 0.75	11.9	96.0	210
0012917	12 G 0.75	14.5	160.0	331
0012919	25 G 0.75	20.3	283.0	596
0012925	2 X 1.0	8.7	49.0	117
0012926	3 G 1.0	9.3	60.0	132
0012927	4 G 1.0	9.9	78.0	163
0012928	5 G 1.0	10.8	88.0	187

Article number	Number of cores and mm <sup>2</sup> per conductor	Outer diameter (mm)	Copper index (kg/km)	Weight (kg/km)
0012929	7 G 1.0	12.8	115.0	255
0012931	12 G 1.0	15.4	201.0	419
0012932	18 G 1.0	17.7	267.0	546
0012933	25 G 1.0	21.5	351.0	738
0012934	34 G 1.0	23.8	498.0	972
0012940	2 X 1.5	9.5	68.0	122
0012941	3 G 1.5	9.9	83.0	140
0012942	4 G 1.5	10.8	102.0	170
0012943	5 G 1.5	11.6	119.0	200
0012944	7 G 1.5	14.2	186.0	290
0012945	12 G 1.5	16.8	264.0	423
0012946	18 G 1.5	20.0	379.0	616
0012947	25 G 1.5	23.5	534.0	804
0012949	41 G 1.5	28.9	803.0	1360
0012950	3 G 2.5	11.4	121.0	194
0012951	4 G 2.5	12.6	145.0	307
0012952	5 G 2.5	14.0	205.0	413
0012953	7 G 2.5	16.4	259.0	533
0012954	12 G 2.5	21.0	407.0	795

Unless specified otherwise, the shown product values are nominal values. Detailed values (e.g. tolerances) are available upon request.  
 Copper price basis: EUR 150/100kg. Refer to Appendix T17 for the definition and calculation of copper-related surcharges.  
 Please find our standard lengths at: [www.lappkabel.de/en/cable-standardlengths](http://www.lappkabel.de/en/cable-standardlengths)  
 Packaging size: coil ≤ 30 kg or ≤ 250 m, otherwise drum  
 Please specify the preferred type of packaging (e.g. 1 x 500 m drum or 5 x 100 m coils).  
 Photographs are not to scale and do not represent detailed images of the respective products.

**Similar products**

- ÖLFLEX® CLASSIC 400 CP refer to main catalogue 2012 page 66

**Accessories**

- SKINTOP® BRUSH ADD-ON refer to page 106
- SKINTOP® MS-SC-M refer to page 104

**Harsh conditions**

High mechanical and chemical resistance

**ÖLFLEX® FORTIS**

Robust, cold temperature and highly oil resistant control cables - multiple UL and CSA listed

LAPP KABEL STUTTGART ÖLFLEX® Fortis (UL) Type TC ER Oil Res I/II E171371 MTW WTTC 1000V 90°C Dry c(UL) Control CIC/TC



**Info**

- Complies with NFPA 79 Edition 2012
- Increased oil resistance and flexibility at cold temperatures

**Benefits**

- Wide application range due to multiple approvals
- Cost-saving, easy installation due to omission of closed raceways (suitable for open wiring)
- Resistant to contact with many mineral oil-based lubricants, diluted acids, aqueous alkaline solutions and other chemical media
- Wide temperature range for applications in harsh climatic environments
- The high flexibility and good dismantling and stripping properties enable easy space-saving cable installation and fast processing

**Application range**

- Machine tools compliant with UL MTW (Machine Tool Wiring)
- Suitable for wet areas within machineries due to higher resistance to oil and moisture
- TC-ER (Tray Cable Exposed Run) approval for open wiring between cable tray and industrial machines/plants acc. to NEC 336.10(7)
- Meets WTTC (UL2277) requirements
- Power supply: Drives, slip ring, lights, heater's, cooler's, fan's, lubrication, 24V DC, battery chargers, brakes
- Wind vane-, air speed-, air humidity measurement, obstruction light
- Cold environment like hub and blade
- Tower and drip loop
- Slip ring - Pitch connection

**Product features**

- Torsion-resistant up to ±150°/m
- Flame-retardant according to CSA FT4 UL Vertical-Tray Flame Test
- High oil-resistance, according to UL OIL RES I and UL OIL RES II
- Water-resistant, UL Wet Approval 75 °C
- Flexible down to -40°C

**Approvals**



- Multi-standard cables have conductor strands with nominal sizes in mm<sup>2</sup> or AWG/kcmil. The master size is mentioned in the table below, while the equivalent size of the other system can be found in the Appendix T16 of this catalogue. For this related secondary size the cross-section of the conductor mostly works out to be greater than the specified nominal value.

**Design**

- Fine-wire strand made of bare copper wires
- Insulation: PVC with nylon sheath (PA skin)
- Cores twisted in layers
- Outer sheath made of robust special polymer  
Colour: black

**Technical data**



**Core identification code**  
Black cores with white numbers



**Approvals**  
UL-listed according to:  
Type TC-ER (Exposed Run)  
Type MTW or UL AWM, NPFA 79 2007  
CSA-listed according to:  
c(UL) Type TC and CIC FT-4 -40°C  
CSA AWM I/II A/B FT-4 -40°C



**Conductor stranding**  
Fine wire according to VDE 0295, class 5/IEC 60228 class 5



**Minimum bending radius**  
5 x outer diameter



**Nominal voltage**  
UL/CSA: 600 V (TC, MTW, CIC), WTTC 1000V  
HAR U<sub>0</sub>/U: 300/500 V



**Test voltage**  
2000 V



**Protective conductor**  
G = with GN-YE protective conductor  
X = without protective conductor



**Temperature range**  
Occasional flexing: -40°C to +90°C (according to AWM +105°C)  
Fixed installation: -55°C to +90°C (according to AWM +105°C)

Article number	Number of cores and mm <sup>2</sup> per conductor	Outer diameter (mm)	Copper index (kg/km)	Weight (kg/km)
<b>ÖLFLEX® FORTIS</b>				
331803	3 G 1.0	7.5	28.8	85
331804	4 G 1.0	8.1	38.4	98
331805	5 G 1.0	8.8	48.0	115
331807	7 G 1.0	9.5	67.0	149
331812	12 G 1.0	12.1	115.0	255
331818	18 G 1.0	14.9	173.0	365
331603	3 G 1.5	8.3	43.0	103
331604	4 G 1.5	8.9	58.0	124
331605	5 G 1.5	9.7	72.0	146
331607	7 G 1.5	10.5	101.0	189
331612	12 G 1.5	14.4	173.0	328
331618	18 G 1.5	16.6	259.0	431
331625	25 G 1.5	18.8	360.0	592

Article number	Number of cores and mm <sup>2</sup> per conductor	Outer diameter (mm)	Copper index (kg/km)	Weight (kg/km)
331403	3 G 2.5	9.2	72.0	130
331404	4 G 2.5	10.0	96.0	159
331405	5 G 2.5	10.8	120.0	191
331407	7 G 2.5	11.8	168.0	252
331412	12 G 2.5	16.2	288.0	459
331204	4 G 4	11.7	153.0	226
331205	5 G 4	12.8	192.0	279
331004	4 G 6	14.7	231.0	394
331005	5 G 6	16.0	288.0	472
330804	4 G 10	17.9	384.0	615
330805	5 G 10	19.6	480.0	771
330604	4 G 16	22.8	615.0	864
330605	5 G 16	24.9	768.0	1080

Unless specified otherwise, the shown product values are nominal values. Detailed values (e.g. tolerances) are available upon request.

Copper price basis: EUR 150/100kg. Refer to Appendix T17 for the definition and calculation of copper-related surcharges.

Please find our standard lengths at: [www.lappkabel.de/en/cable-standardlengths](http://www.lappkabel.de/en/cable-standardlengths)

Packaging size: coil ≤ 30 kg or ≤ 250 m, otherwise drum

Please specify the preferred type of packaging (e.g. 1 x 600 m drum or 8 x 75 m coils).

Photographs are not to scale and do not represent detailed images of the respective products.

**Similar products**

- ÖLFLEX® CONTROL TM refer to page 30
- ÖLFLEX® CONTROL TM CY refer to page 31

**Accessories**

- SKINTOP® ST-M refer to page 97
- SKINTOP® MS-M refer to page 102
- SKINTOP® COLD refer to main catalogue 2012 page 664

**ÖLFLEX® 550 P**

**PUR power cords with European harmonisation (HAR)**

**Info**

- High mechanical strength
- Good oil resistance
- H05BQ-F/H07BQ-F design standard



**Benefits**

- Europe-wide use due to harmonisation
- Increased durability under harsh conditions thanks to robust PUR outer sheath
- Resistant to contact with many mineral oil-based lubricants, diluted acids, aqueous alkaline solutions and other chemical media
- Wide temperature range for applications in harsh climatic environments
- The signal colour of the outer sheath increases safety and visual perception

**Application range**

- Portable handheld electrical devices such as drills, sanders, jig saws or grinders
- For indoor and outdoor use
- Power supply: Drives, slip ring, lights, heater's, cooler's, fan's, lubrication, 24V DC, battery chargers, brakes
- Cabinet doors
- Slip ring – Pitch connection

**Product features**

- Oil-resistant
- Abrasion and notch-resistant
- Flexible down to -40°C
- Resistant to hydrolysis and microbes

**Approvals**



**Design**

- Fine-wire strand made of bare copper wires
- Core insulation: rubber compound
- Cores twisted together
- PUR outer sheath
- Sheath colour: orange (RAL 2003)

**Technical data**

- Core identification code**  
Colours according to VDE 0293-308, refer to Appendix T9
- Approvals**  
H05BQ-F;H07BQ-F / HD22.10  
VDE 0282 Part 10/HD 22.10
- Specific insulation resistance**  
> 10 GOhm x cm
- Conductor stranding**  
Fine wire according to VDE 0295, class 5/IEC 60228 class 5
- Minimum bending radius**  
For flexible use:  
12,5 x outer diameter  
Fixed installation:  
4 x outer diameter
- Nominal voltage**  
Up to 1.0 mm<sup>2</sup>: U<sub>0</sub>/U: 300/500 V  
From 1.5 mm<sup>2</sup>: U<sub>0</sub>/U: 450/750 V
- Test voltage**  
3000 V
- Protective conductor**  
G = with GN-YE protective conductor  
X = without protective conductor
- Temperature range**  
Occasional flexing: -40 °C to +90 °C  
Fixed installation: -50°C to +90°C

Article number	Number of cores and mm <sup>2</sup> per conductor	Outer diameter (mm)	Copper index (kg/km)	Weight (kg/km)
<b>ÖLFLEX® 550 P U<sub>0</sub>/U: 300/500 V</b>				
0013600	2 X 0.75	6.4	14.4	50
0013601	3 G 0.75	7.0	21.6	64
00136023	4 G 0.75	7.6	28.8	78
00136033	5 G 0.75	8.5	36.0	98
0013610	2 X 1.0	7.0	19.2	60
0013611	3 G 1.0	7.4	29.0	74
00136123	4 G 1.0	8.1	38.4	92
00136133	5 G 1.0	9.0	48.0	114
<b>ÖLFLEX® 550 P U<sub>0</sub>/U: 450/750 V</b>				
0013620	2 X 1.5	8.4	29.0	87
0013621	3 G 1.5	8.9	43.0	108
00136223	4 G 1.5	9.9	58.0	137
00136233	5 G 1.5	10.8	72.0	165
0013630	2 X 2.5	10.0	48.0	90
0013631	3 G 2.5	10.6	72.0	161
00136323	4 G 2.5	11.8	96.0	206
00136333	5 G 2.5	13.1	120.0	254

Unless specified otherwise, the shown product values are nominal values. Detailed values (e.g. tolerances) are available upon request.  
Copper price basis: EUR 150/100kg. Refer to Appendix T17 for the definition and calculation of copper-related surcharges.  
Please find our standard lengths at: [www.lappkabel.de/en/cable-standardlengths](http://www.lappkabel.de/en/cable-standardlengths)  
Packaging size: coil ≤ 30 kg or ≤ 250 m, otherwise drum  
Please specify the preferred type of packaging (e.g. 1 x 500 m drum or 5 x 100 m coils).  
Photographs are not to scale and do not represent detailed images of the respective products.

**Similar products**

- ÖLFLEX® ROBUST 200 refer to main catalogue 2012 page 62
- H05RN-F refer to main catalogue 2012 page 79
- H07RN-F refer to page 42
- ÖLFLEX® 500 P refer to main catalogue 2012 page 74
- ÖLFLEX® 540 P refer to main catalogue 2012 page 75

**Accessories**

- Cutting tools for various applications refer to main catalogue 2012 from page 902
- Stripping tools refer to main catalogue 2012 page 905
- SKINTOP® MS-M refer to page 102
- SKINTOP® ST-M refer to page 97

**Harsh conditions**

Rubber cables

**H07RN-F**

Heavy standard construction



**Benefits**

- Heavy-duty, rubber-sheathed cable
- High stresses
- Permitted up to 1000 V (0.6/1 kV) alternating voltage for protected and fixed installation
- Arrangements made of single-core, rubber-sheathed cables H07RN-F can be used for short circuit-proof and short-to-ground-proof installations in accordance with VDE 0100 Part 520
- Type-compliant versions <HAR>-certified with "<HAR>" testing and certification mark for accelerated granting of approvals if final application of cable is within the European CENELEC area

**Application range**

- Handheld and power supply devices according to HD 516/VDE 0298-300
- According to HD 516/VDE 0298-300:... for medium mechanical stress; for mobile engines and machinery; on plaster; not for submersion except for exceptional, brief flooding (see H07RN8-F cable for submersible pumps); areas with an explosion hazard, in addition to individual, national provisions/guidelines/legislation/standards/norms that may apply in specific cases;

- Dry or damp rooms as well as outdoors (taking into account all normative power characteristics) according to HD 516/VDE 0298-300
- Light & sound technology
- Power supply: Drives, slip ring, lights, heater's, cooler's, fan's, lubrication, 24V DC, battery chargers, brakes
- Wind vane-, air speed-, air humidity measurement, obstruction light

**Product features**

- Flame-retardant according to IEC 60332-1-2
- Oil-resistant according to EN 60811-2-1
- Normatively not ozone-resistant according to HD 22.4/VDE 0282-4 and HD 22.1/VDE 0282-1

**Approvals**



**Design**

- Bare copper wire according to HAR
- Core insulation: rubber compound type EI 4
- Outer sheath: rubber compound, type EM2



**Info**

- Harmonised (HAR)
- International use

**Technical data**



**Core identification code**

Up to 5 cores: colour-coded according to VDE 0293-308, refer to Appendix T9  
From 6 cores: black with white numbers



**Approvals**

VDE 0282 Part 4/HD 22.4



**Specific insulation resistance**

1 GOhm x cm



**Conductor stranding**

Fine wire according to VDE 0295 Class 5/ IEC 60228 Class 5



**Minimum bending radius**

According to HD 516/VDE 0298-300, table 6(c): 3 x up to 8 x cable outer diameter, depending on the outer diameter and application involved



**Nominal voltage**

U<sub>0</sub>/U: 450/750 V



**Test voltage**

2500 V



**Protective conductor**

G = with GN-YE protective conductor  
X = without protective conductor



**Current rating**

According to VDE 0298 part 4 Tab. 11 and 13 HD 516/VDE 0298-300



**Temperature range**

According to HD 516/VDE 0298-300:... Flexible use and fixed installation: -25 °C to +60 °C at the conductor; maximum cable surface temperature: +50 °C  
According to HD 516/VDE 0298-300: minimum laying and handling temperature: -25 °C; maximum ambient temperature for storage: +40 °C

Article number	Number of cores and mm <sup>2</sup> per conductor	Outer diameter (mm)	Copper index (kg/km)	Weight (kg/km)
1600096	1 X 1.5	5.7 - 7.1	14.4	59
1600099	1 X 2.5	6.3 - 7.9	24.0	72
1600097	1 X 4	7.2 - 9.0	38.4	99
1600098	1 X 6	7.9 - 9.8	57.6	130
1600194	1 X 10	9.5 - 11.9	96.0	230
1600195	1 X 16	10.8 - 13.4	153.6	320
1600196	1 X 25	12.7 - 15.8	240.0	450
1600193	1 X 35	14.3 - 17.9	336.0	605
1600197	1 X 50	16.5 - 20.6	480.0	825
1600189	1 X 70	18.6 - 23.3	672.0	1090
1600190	1 X 95	20.8 - 26.0	912.0	1405
1600198	1 X 120	22.8 - 28.6	1,152.0	1745
1600191	1 X 150	25.2 - 31.4	1,440.0	1887
1600175	1 X 185	27.6 - 34.4	1,776.0	2274
1600177	1 X 240	30.6 - 38.3	2,304.0	2955
30015435	1 X 300	33.5 - 41.9	2,880.0	3479
1600117	3 G 1.0	8.3 - 10.7	28.8	130
1600199	2 X 1.5	8.5 - 11.0	28.8	135
1600103	3 G 1.5	9.2 - 11.9	43.2	165
16001233	4 G 1.5	10.2 - 13.1	57.6	200
16001043	5 G 1.5	11.2 - 14.4	72.0	240
1600151	7 G 1.5	14.0 - 17.5	100.8	385
1600148	12 G 1.5	17.6 - 22.4	172.8	516
1600259	19 G 1.5	20.7 - 26.3	273.6	800
1600166	24 G 1.5	24.3 - 30.7	345.6	882
1600263	25 G 1.5	25.1 - 25.9	360.0	920
1600187	2 X 2.5	10.2 - 13.1	48.0	195
1600118	3 G 2.5	10.9 - 14.0	72.0	235
16001053	4 G 2.5	12.1 - 15.5	96.0	290
16001293	5 G 2.5	13.3 - 17.0	120.0	294
1600152	7 G 2.5	16.5 - 20.0	168.0	520

Article number	Number of cores and mm <sup>2</sup> per conductor	Outer diameter (mm)	Copper index (kg/km)	Weight (kg/km)
1600154	12 G 2.5	20.6 - 26.2	288.0	810
1600156	19 G 2.5	25.5 - 31.0	456.0	1200
1600157	24 G 2.5	28.8 - 36.4	576.0	1650
1600186	2 X 4	11.8 - 15.1	76.8	270
1600119	3 G 4	12.7 - 16.2	115.2	320
16001063	4 G 4	14.0 - 17.9	153.6	395
16001303	5 G 4	15.6 - 19.9	192.0	485
1600161	7 G 4	21.0 - 21.8	268.8	681
1600120	3 G 6	14.1 - 18.0	172.8	360
16001073	4 G 6	15.7 - 20.0	230.4	475
16001313	5 G 6	17.5 - 22.2	288.0	760
1600121	3 G 10	19.1 - 24.2	288.0	880
16001083	4 G 10	20.9 - 26.5	384.0	1060
16001093	5 G 10	22.9 - 29.1	480.0	1300
1600122	3 G 16	21.8 - 27.6	460.8	1090
16001103	4 G 16	23.8 - 30.1	614.4	1345
16001113	5 G 16	26.4 - 33.3	768.0	1680
16001123	4 G 25	28.9 - 36.6	960.0	1995
16001133	5 G 25	32.0 - 40.4	1,200.0	2470
1600124	3 G 35	29.3 - 37.1	1,008.0	1910
16001143	4 G 35	32.5 - 41.1	1,344.0	2645
16001363	5 G 35	37.0 - 45.0	1,680.0	2810
16001153	4 G 50	37.7 - 47.5	1,920.0	3635
1600126	5 G 50	40.0 - 50.8	2,400.0	4050
16001163	4 G 70	42.7 - 54.0	2,688.0	4830
16001283	4 G 95	48.4 - 61.0	3,648.0	6320
16001323	4 G 120	53.0 - 66.0	4,608.0	8830
16000883	4 G 150	58.0 - 73.0	5,760.0	8320
1600141	4 G 185	64.0 - 80.0	7,104.0	9800
1600183	4 G 240	72.0 - 91.0	9,216.0	12800

Unless specified otherwise, the shown product values are nominal values. Detailed values (e.g. tolerances) are available upon request.

Copper price basis: EUR 150/100kg. Refer to Appendix T17 for the definition and calculation of copper-related surcharges.

Please find our standard lengths at: [www.lappkabel.de/en/cable-standardlengths](http://www.lappkabel.de/en/cable-standardlengths)

Packaging size: coil ≤ 30 kg or ≤ 250 m, otherwise drum

Please specify the preferred type of packaging (e.g. 1 x 500 m drum or 5 x 100 m coils).

Photographs are not to scale and do not represent detailed images of the respective products.

Cross-sections 5G35 and 5G50 without <HAR>

**Similar products**

- H07ZZ-F refer to main catalogue 2012 page 81
- H07RN8-F refer to main catalogue 2012 page 86

**Accessories**

- SKINTOP® CLICK / CLICK-R refer to page 99
- EASY STRIP 2 stripping and cutting tool refer to main catalogue 2012 page 905
- PEW 8.87 crimping pliers refer to main catalogue 2012 page 916
- KS 20 cable shears refer to main catalogue 2012 page 904

## H07BN4-F Wind Class5

High torsion-resistance, harmonised cable for use in the drip-loop of wind turbines



**Info**

- ±150 °/M TORSION FOR THE DRIP LOOP
- Harmonised (HAR)
- Ozone-resistant

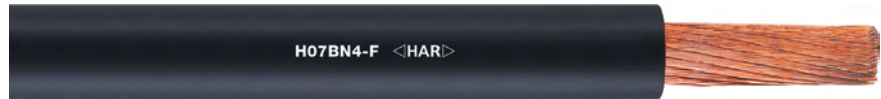

**Benefits**

- Designed to withstand high-torsion in the windmill drip loop
- Type-compliant versions <HAR>-certified with "<HAR>" testing and certification mark for accelerated granting of approvals if final application of cable is within the European CENELEC area

**Application range**

- Recommended for use in wind turbine drip-loops - designed according to the needs of wind turbine builders
- For mobile use, and possible for fixed installations
- In dry or wet environment
- Tower and drip loop

**Product features**

- ATTENTION: only the "H07BN4-F Wind Class5" and "H07BN4-F Wind Class6" are torsion-resistant. The standard "H07BN4-F", which is not listed in the LAPP GROUP main catalogue, is not torsion-resistant!
- Flame-retardant according to IEC 60332-1-2
- Torsion-resistant up to ±150°/m
- Oil-resistant to most transmission oils
- Abrasion and cut-resistant; flexible at low temperatures; ozone-resistant according to HD 22, EN 60811-2-1 and EN 50396-8.1.3

**Approvals**



**Design**

- Strands of bare copper wires
- Core insulation: rubber compound type EI 7
- Outer sheath: special rubber compound, based on type EM7

**Technical data**

	<b>Approvals</b> VDE 0282 Part 12/HD 22.12
	<b>Conductor stranding</b> H07BN4-F Wind Class 5: fine-wire, Class 5 according to VDE 0295/IEC 60228 H07BN4-F Wind Class 6: extra-fine wire, Class 6 according to VDE 0295/IEC 60228
	<b>Minimum bending radius</b> Flexible use: 6 x outer diameter Fixed installation: 5 x outer diameter
	<b>Nominal voltage</b> U0/U: 450/750 VAC In protected and fixed installations: U0/U: 600/1000 V
	<b>Test voltage</b> 2500 V
	<b>Current rating</b> VDE 0298 Part 4 HD 516/VDE 0298-300
	<b>Temperature range</b> Flexible use: -15°C to +90°C; Wind power plants: -40°C to +90°C Fixed installation: -40°C to +90°C

Article number	Conductor cross-section (mm²)	Outer diameter (mm)	Copper index (kg/km)	Weight (kg/km)
1600751	95	20.8 - 23.5	912.0	1300
1600752	120	22.8 - 25.0	1,152.0	1500
1600753	150	25.2 - 27.8	1,440.0	1850
1600754	185	27.6 - 30.1	1,776.0	2200
1600755	240	30.6 - 33.9	2,304.0	2900
1600756	300	33.5 - 36.7	2,880.0	3400
1600757	400	37.4 - 46.8	3,840.0	4400

Unless specified otherwise, the shown product values are nominal values. Detailed values (e.g. tolerances) are available upon request.  
Copper price basis: EUR 150/100kg. Refer to Appendix T17 for the definition and calculation of copper-related surcharges.  
Please find our standard lengths at: [www.lappkabel.de/en/cable-standardlengths](http://www.lappkabel.de/en/cable-standardlengths)  
Photographs are not to scale and do not represent detailed images of the respective products.

**Accessories**

- STAR STRIP stripping tool refer to main catalogue 2012 page 906
- Cable shears KT 4 and KT 5 refer to main catalogue 2012 page 904

**Harsh conditions**

Rubber cables

# NSGAFÖU 1.8/3 kV

Flexible single-conductor rubber cable with 1.8/3 kV rated voltage



**Info**

- Medium voltage
- Normative rated voltage classes  $U_0/U$  0.6/1 kVAc and 3.6/6 kVAc available on request

**Benefits**

- Arrangements made of single-conductor cables NSGAFÖU in accordance with VDE 0250 Part 602 with nominal voltage of at least  $U_0/U$ : 1.8/3 kV can be used for short-circuit-proof and short-to-ground-proof installation up to 1000 V in acc. with VDE 0100 Part 520 and VDE 0298 Part 3

**Application range**

- Wiring of machines and control cabinets
- Switching stations (short-circuit-proof up to 1000 V), power distributors (short-circuit-proof up to 1000 V)
- No direct burial, except of lead-through through fire separations such as sand cups
- In ducts, tubes, pipes, conduits and closed installation channels
- Bundled or for connection of movable parts
- MV Tower
- MV Transformer - Frequency Converter

**Product features**

- Flame-retardant according to IEC 60332-1-2
- Oil-resistant according to EN 60811-2-1

**Approvals**



- The "CE" mark is forbidden as the normative nominal voltage  $U_0/U = 1.8/3$  kVAc falls outside low voltage as defined by the EC Low Voltage Directive 2006/95/EC, which is the standard to which the "CE" mark on most of the cables that we sell refers

**Design**

- Fine-wire strand made of tinned-copper wires
- Core insulation: rubber compound type 3GI3
- Outer coating: rubber compound, type 5GM3, black, different colours on request
- No outer sheath

**Technical data**



**Approvals**

VDE 0250 Part 602



**Conductor stranding**

Fine wire according to VDE 0295 Class 5/ IEC 60228 Class 5



**Minimum bending radius**

Flexible use: 10 x outer diameter  
Fixed installation: 6 x outer diameter



**Nominal voltage**

$U_0/U$ : 1.8/3 kV



**Test voltage**

6000 V



**Current rating**

According to VDE 0298 Part 4, Table 15



**Temperature range**

Flexible use: -25°C to +90°C  
Fixed installation: -40°C to +90°C

Article number	Conductor cross-section (mm <sup>2</sup> )	Outer diameter (mm)	Copper index (kg/km)	Weight (kg/km)
1600300	1.5	7.0	14.4	60
1600301	2.5	7.5	24.0	70
1600302	4	9.0	38.4	90
1600303	6	9.5	57.6	120
1600304	10	11.0	96.0	180
1600305	16	13.0	153.6	250
1600306	25	15.0	240.0	390
1600307	35	16.5	336.0	470
1600308	50	18.0	480.0	625
1600309	70	20.5	672.0	880
1600310	95	24.0	912.0	1190
1600311	120	26.0	1,152.0	1430
1600312	150	28.0	1,440.0	1750
1600313	185	31.0	1,776.0	2160
1600314	240	34.5	2,304.0	2640
3026826	300	38.0	2,880.0	3545

Unless specified otherwise, the shown product values are nominal values. Detailed values (e.g. tolerances) are available upon request.

Copper price basis: EUR 150/100kg. Refer to Appendix T17 for the definition and calculation of copper-related surcharges.

Please find our standard lengths at: [www.lappkabel.de/en/cable-standardlengths](http://www.lappkabel.de/en/cable-standardlengths)

Packaging size: coil ≤ 30 kg or ≤ 250 m, otherwise drum

Please specify the preferred type of packaging (e.g. 1 x 500 m drum or 5 x 100 m coils).

Photographs are not to scale and do not represent detailed images of the respective products.

**Accessories**

- V 1311 pressing pliers, hydraulic refer to main catalogue 2012 page 930
- KS 20 cable shears refer to main catalogue 2012 page 904

**New**

**ÖLFLEX® SERVO FD 796 CP**

LAPP KABEL STUTTGART ÖLFLEX® SERVO FD 796 CP CE



**Info**

- New high-end version! For very dynamic motion sequences
- Slim = less space required
- Multiple certifications

**Benefits**

- Multi-standard = fewer part varieties = cost savings
- Suitable for use with servomotor drive systems from leading manufacturers
- The advantage: the modified design of the control core pairs means the longitudinal voltage drop is lower; it also permits considerably higher operating voltages in the auxiliary circuits
- To substitute 7 ÖLFLEX® SERVO FD product lines: 755CP/-755CP DESINA/-781CP/-785CP/-785CP DESINA/-790CP/-795CP

**Application range**

- Connecting cable between servo controller and motor
- In moving machine parts
- For use in assembling & pick-and-place machinery
- Particularly in wet areas of machine tools and transfer lines
- Pitchdrives with Servo Motors

**Product features**

- Dynamic performance in power chains: Acceleration up to 50 m/s<sup>2</sup>. Travel speeds up to 5 m/s. Travel distances up to 100 m.
- Low-capacitance design: this may result in lower EMI interference, depending on the drive's electrical operating conditions.
- Halogen-free materials
- Flame retardancy: UL/CSA: VW-1, FT1. IEC/EN: 60332-1-2
- Oil-resistant

**Approvals**

- For use in power chains: Please comply with the assembly guidelines listed in Appendix T3

**Design**

- Extra-fine wire strand made of bare copper wires (class 6)
- Core insulation: polypropylene (PP)
- Individual design depending on the item: power cores with or without one pair, or with two control core pairs, in pairs, with screening, twisted together in short lay lengths
- Non-woven wrapping
- Tinned-copper braiding
- PUR outer sheath, orange (RAL 2003)

**Technical data**

**Core identification code**  
Power: black cores with marking U/L1/C/L+; V/L2; W/L3/D /L- and 1 green-yellow core  
Optional designs with one pair of control cores: black; white  
Two pairs of control cores: black with white numbers: 5, 6, 7, 8

**Approvals**  
VDE - Reg. - No. 8591  
UL AWM Style 20234  
CSA AWM I/II, A/B 1000 V 80° FT 1

**Specific insulation resistance**  
> 20 GOhm x cm

**Conductor stranding**  
Extra-fine wire according to VDE 0295, class 6/IEC 60228 class 6

**Minimum bending radius**  
For flexible use:  
7.5 x outer diameter (1.5-16 mm<sup>2</sup>)  
10 x outer diameter (25-50 mm<sup>2</sup>)  
Fixed installation: 4 x outer diameter

**Nominal voltage**  
VDE: power cores and control cores: U0/U: 600/1000 V  
UL & CSA: 1000 V

**Test voltage**  
Core/Core: 4 kV  
Core/Screen: 4 kV

**Protective conductor**  
G = with GN-YE protective conductor

**Temperature range**  
Flexing: -40°C to +80°C  
Fixed installation: -50°C to +80°C

Article number	Number of cores and mm <sup>2</sup> per conductor	Outer diameter (mm)	Copper index (kg/km)	Weight (kg/km)
<b>ÖLFLEX® SERVO FD 796 CP</b>				
0027950	4 G 1,5	9.2	79.0	140
0027951	4 G 2,5	10.6	129.0	197
0027952	4 G 4	11.9	186.0	268
0027953	4 G 6	14.4	296.0	397
0027954	4 G 10	17.6	449.0	591
0027955	4 G 16	22.0	716.0	955
0027956	4 G 25	25.2	1,073.0	1337
0027957	4 G 35	28.7	1,480.0	1769
0027958	4 G 50	33.4	2,115.0	2468
0027959	4 G 1,5 + (2 x 1,5)	12.0	135.0	261
0027960	4 G 2,5 + (2 x 1,5)	13.8	188.0	318
0027961	4 G 4 + (2 x 1,5)	14.9	235.0	385
0027962	4 G 6 + (2 x 1,5)	17.0	329.0	486

Article number	Number of cores and mm <sup>2</sup> per conductor	Outer diameter (mm)	Copper index (kg/km)	Weight (kg/km)
0027963	4 G 10 + (2 x 1,5)	19.4	515.0	701
0027964	4 G 16 + (2 x 1,5)	23.8	757.0	1048
0027965	4 G 25 + (2 x 1,5)	27.0	1,147.0	1532
0027966	4 G 35 + (2 x 1,5)	31.2	1,538.0	2097
0027967	4 G 50 + (2 x 1,5)	34.7	2,181.0	2721
0027969	4 G 1,5 + 2 x (2 x 0,75)	12.2	151.0	313
0027970	4 G 2,5 + 2 x (2 x 1,0)	14.6	209.0	395
0027971	4 G 4 + (2 x 1,0) + (2 x 1,5)	16.3	336.0	485
0027972	4 G 6 + (2 x 1,0) + (2 x 1,5)	18.1	438.0	588
0027973	4 G 10 + (2 x 1,0) + (2 x 1,5)	21.8	602.0	819
0027974	4 G 16 + 2 x (2 x 1,5)	25.5	794.0	1135
0027975	4 G 25 + 2 x (2 x 1,5)	28.9	1,179.0	1559
0027976	4 G 35 + 2 x (2 x 1,5)	31.4	1,580.0	2093
0027977	4 G 50 + 2 x (2 x 2,5)	36.8	2,249.0	2920

Unless specified otherwise, the shown product values are nominal values. Detailed values (e.g. tolerances) are available upon request.  
Please find our standard lengths at: [www.lappkabel.de/en/cable-standardlengths](http://www.lappkabel.de/en/cable-standardlengths)  
Photographs are not to scale and do not represent detailed images of the respective products.

**Similar products**

- ÖLFLEX® SERVO 709 CY refer to main catalogue 2012 page 91

**Accessories**

- Circular connectors refer to main catalogue 2012 from page 597
- SKINDICHT® EMC/Earthing refer to main catalogue 2012



**Power chain applications**

Various applications, approved

**New**

**ÖLFLEX® CHAIN 809 CY**

Screened, PVC-insulated, numbered, PVC-sheath, approved

LAPP KABEL STUÏGART ÖLFLEX® CHAIN 809 CY CE



**Info**

- Basic Line for light & ordinary duty in power chain applications

**Benefits**

- Good combination of quality and price
- Compact design

**Application range**

- In moving machine parts
- In EMC-sensitive environments
- Suitable for use in measuring, control and regulating circuits
- Wiring of machines, devices, appliances and control cabinets
- Only for outdoor use within the indicated operating temperature range, with UV-protection
- Pitchdrives with Servo Motors

**Product features**

- Low-adhesive surface
- Designed for 1...2 million bending/unbending cycles in the power chain.  
Further information regarding service life see T0 of the Lapp main catalogue's appendix.
- Flame retardancy:  
UL/CSA: VW-1, FT1.  
IEC/EN: 60332-1-2

**Approvals**



- For travel distances up to 10 m.
- For use in power chains: Please comply with the assembly guidelines listed in Appendix T3

**Design**

- Fine copper wire strands
- Core insulation: PVC
- Cores twisted in layers
- Non-woven wrapping
- Tinned-copper braiding
- Non-woven wrapping
- PVC outer sheath, grey (RAL 7001)

**Technical data**



**Core identification code**  
Black with white numbers acc. to VDE 0293



**Approvals**  
cUL AWM II A/B FT1  
UL-AWM-Style 20886



**Based on**  
HD 21.13 S1; VDE 0281 Part 13



**Specific insulation resistance**  
> 20 GOhm x cm



**Conductor stranding**  
Fine wire according to VDE 0295 Class 5/  
IEC 60228 Class 5



**Minimum bending radius**  
For flexible applications:  
Chains in self supporting non-gliding arrangements: 10 x outside diameter  
Chains in gliding arrangements: 12 x outside diameter  
Fixed installation: 4 x outer diameter



**Nominal voltage**  
VDE: U<sub>0</sub>/U: 300/500 V  
UL & CSA: 1000 V



**Test voltage**  
Core/core: 4000 V  
Core/screen: 2000 V



**Protective conductor**  
G = with GN-YE protective conductor  
X = without protective conductor



**Temperature range**  
Flexing: VDE 0 °C to +70 °C UL 0 °C to +80 °C  
Fixed installation: VDE -40 °C to +70 °C; UL/CSA -40 °C to +80 °C;

Article number	Number of cores and mm² per conductor	Outer diameter (mm)	Copper index (kg/km)	Weight (kg/km)
1026751	2 X 0.5	5.8	36.0	45
1026752	3 G 0.5	6.1	43.0	59
1026753	4 G 0.5	6.6	49.0	83
1026754	5 G 0.5	7.1	57.0	96
1026755	7 G 0.5	8.5	69.0	136
1026756	12 G 0.5	10.0	104.0	200
1026757	18 G 0.5	11.8	141.0	275
1026758	25 G 0.5	14.1	211.0	350
1026759	2 X 0.75	6.2	43.0	56
1026760	3 G 0.75	6.6	52.0	70
1026761	4 G 0.75	7.1	61.0	95
1026762	5 G 0.75	7.7	72.0	130
1026763	7 G 0.75	9.1	89.0	168
1026764	12 G 0.75	10.9	138.0	232
1026765	18 G 0.75	13.0	211.0	315
1026766	25 G 0.75	15.6	280.0	435
1026767	2 X 1.0	6.5	51.0	84
1026768	3 G 1.0	6.9	62.0	110

Article number	Number of cores and mm² per conductor	Outer diameter (mm)	Copper index (kg/km)	Weight (kg/km)
1026769	4 G 1.0	7.5	74.0	130
1026770	5 G 1.0	8.3	88.0	156
1026771	7 G 1.0	9.8	112.0	192
1026772	12 G 1.0	11.7	185.0	285
1026773	18 G 1.0	14.0	268.0	395
1026774	25 G 1.0	16.7	354.0	486
1026775	2 X 1.5	7.1	65.0	97
1026776	3 G 1.5	7.5	82.0	125
1026777	4 G 1.5	8.4	100.0	165
1026778	5 G 1.5	9.1	119.0	193
1026779	7 G 1.5	10.9	154.0	245
1026780	12 G 1.5	13.3	268.0	365
1026781	18 G 1.5	15.7	373.0	553
1026782	25 G 1.5	18.7	530.0	734
1026783	3 G 2.5	9.0	118.0	188
1026784	4 G 2.5	10.1	147.0	236
1026785	7 G 2.5	13.5	253.0	340
1026788	4 G 4	11.9	248.0	305

Unless specified otherwise, the shown product values are nominal values. Detailed values (e.g. tolerances) are available upon request.  
Please find our standard lengths at: [www.lappkabel.de/en/cable-standardlengths](http://www.lappkabel.de/en/cable-standardlengths)  
Packaging size: Coil 100 m; Drum (500; 1000) m  
Photographs are not to scale and do not represent detailed images of the respective products.

**Similar products**

- ÖLFLEX® FD CLASSIC 810 CY refer to main catalogue 2012 page 109
- ÖLFLEX® CHAIN 815 CY refer to main catalogue 2012 page 110
- ÖLFLEX® CHAIN 879 CY refer to main catalogue 2012 page 128

**Accessories**

- EPIC® Industrial connectors refer to main catalogue 2012
- SKINTOP® MS-SC-M refer to page 104
- SKINTOP® MS-M BRUSH refer to page 105

# ÖLFLEX® TRAFFIC 3GKW

Single-core cable for more demanding requirements in railway applications

LAPP KABEL STUFGART ÖLFLEX® TRAFFIC 3GKW CE



**Info**

- Meets the highest fire-protection requirements

**Benefits**

- High flexibility and slim diameters enable small bending radii for fixed installation
- Easy to strip and dismantle
- Resistant to mechanical influences in harsh environmental conditions
- Extended temperature range
- Reduced formation of toxic gases and fire spreading in the event of fire increase the protection against damage to persons and property

**Application range**

- Suitable for connecting to fixed and moving objects such as terminal boxes and power supplies
- Slip ring – Pitch connection

**Product features**

- Fire behaviour:
  - Halogen-free (IEC 60754-1)
  - No corrosive gases (IEC 60754-2)
  - No toxic gases (EN 50305)
  - Low smoke density (IEC 61034)
  - Flame-retardant (IEC 60332-1-2)
  - No fire propagation (IEC 60332-3-24)
  - Low fire load (DIN 51900)
- Chemical properties:
  - Oil and fuel resistance (EN 50305)
  - Ozone resistance (EN 50305)
  - No fluorine (EN 60684-2)

**Approvals**



**Design**

- Tinned-copper strand, fine-wire
- Electron beam cross-linked polyolefin copolymer insulation
- Colour: grey or green-yellow

**Technical data**

- Conductor stranding**  
Fine wire according to VDE 0295, class 5 (SRC = Special Round Conductor)
- Minimum bending radius**  
< 10 mm fixed installation > 3 x D  
Occasional movement > 5 x D  
> 10 mm fixed installation > 4 x D  
Occasional movement > 6 x D
- Nominal voltage**  
U<sub>0</sub>/U AC 0.6/1 kV  
U<sub>0</sub>/U DC 0.9/1.5 kV
- Test voltage**  
Test voltage: 4000 V
- Temperature range**  
Occasional flexing:  
-35 °C to +90 °C  
Short circuit: +200 °C  
Fixed installation:  
-45 °C to +120 °C

Article number	Conductor cross-section (mm²)	Outer diameter (mm)	Copper index (kg/km)	Weight (kg/km)	Fire load (kWh/m)
<b>ÖLFLEX® TRAFFIC 3GKW - grey</b>					
4223293	0.5	2.0	4.8	8	0.014
4223294	0.75	2.2	7.2	11	0.017
4223295	1	2.4	9.6	14	0.020
4223296	1.5	2.7	14.4	21	0.023
4223297	2.5	3.4	24.0	31	0.034
4223298	4	3.9	38.4	46	0.040
4223299	6	4.4	57.6	66	0.047
4223300	10	5.3	96.0	106	0.059
4223301	16	7.0	154.0	164	0.081
4223302	25	8.4	240.0	238	0.124
4223303	35	9.5	336.0	330	0.142
4223304	50	11.9	480.0	483	0.200
4223305	70	14.1	672.0	674	0.262
4223306	95	15.4	912.0	883	0.288
4223307	120	17.4	1,152.0	1103	0.357
4223308	150	20.1	1,440.0	1370	0.480
<b>ÖLFLEX® TRAFFIC 3GKW - green-yellow</b>					
4223314	0.75	2.2	7.2	11	0.017
4223316	1.5	2.7	14.4	21	0.023
4223317	2.5	3.4	24.0	31	0.034
4223318	4	3.9	38.4	46	0.040
4223319	6	4.4	57.6	66	0.047
4223320	10	5.3	96.0	106	0.059
4223321	16	7.0	154.0	164	0.081
4223322	25	8.4	240.0	238	0.134
4223323	35	9.5	336.0	330	0.142
4223324	50	11.9	480.0	483	0.200
4223325	70	14.1	672.0	674	0.262

Unless specified otherwise, the shown product values are nominal values. Detailed values (e.g. tolerances) are available upon request.  
 Copper price basis: EUR 150/100kg. Refer to Appendix T17 for the definition and calculation of copper-related surcharges.  
 Please find our standard lengths at: [www.lappkabel.de/en/cable-standardlengths](http://www.lappkabel.de/en/cable-standardlengths)  
 Packaging size: coil ≤ 30 kg or ≤ 250 m, otherwise drum  
 Please specify the preferred  
 Photographs are not to scale and do not represent detailed images of the respective products.

**Similar products**

- ÖLFLEX® TRAFFIC 4GKW-AXplus refer to main catalogue 2012 page 143

**New**

# ÖLFLEX® TRAFÖ XLV 1.8/3 kV

Flexible and mechanically robust single-core connection cables



Info

- Voltage rating 1.8/3 kV
- Suitable for direct burial
- Halogen-free and flame-retardant

### Benefits

- Reinforced outer sheath gives enhanced protection against mechanical stress
- Wide temperature range for applications in harsh climatic environments
- Reduction of flame propagation as well as of toxic combustion gases in the event of fire
- For outdoor use, and if the general installation guidelines are followed, this is also suitable for direct burial
- Flexible and fine-wired conductor design enables easy on-site installation

### Application range

- Applications with voltage rating 1.8/3 kV
- In the field of renewable energy and conventional power generation
- As connection between the converter and the transformer substation

### Product features

- Good weather, abrasion, temperature and UV-resistance
- Good heat pressure resistance
- Halogen-free and flame-retardant
- Torsion-tested for wind turbines

### Approvals



- Weather/UV-resistant acc. to HD 605/A1
- Flame-retardant according to IEC 60332-1-2
- Halogen-free according to IEC 60754-1
- Ozone-resistant according to EN 50396
- Direct burial according to UL 1277

### Design

- Conductor: fine-wire tinned-copper strands
- Core insulation: cross-linked polyolefin
- Outer sheath: cross-linked copolymer
- Core insulation and outer sheath are extruded together
- Outer sheath colour: black

### Technical data

- Core identification code**  
Colour: black (RAL 9005)
- Fire test**  
Flame-retardant according to IEC 60332-1-2
- Conductor stranding**  
Fine wire according to VDE 0295, class 5/IEC 60228 class 5
- Minimum bending radius**  
Occasional flexing: 15 x outer diameter  
Fixed installation: 5 x outer diameter
- Nominal voltage**  
U<sub>0</sub>/U: 1.8/3 kV
- Test voltage**  
AC 6500 V
- Temperature range**  
Flexing: -40 °C to +90 °C  
Fixed installation: -40 °C to +90 °C

Article number	Conductor cross-section (mm <sup>2</sup> )	Outer diameter (mm)	Copper index (kg/km)	Weight (kg/km)
<b>ÖLFLEX® TRAFÖ XLV 1,8/3 kV</b>				
1151010	95.0	22.1	912.0	1218
1151011	120.0	24.4	1,152.0	1496
1151012	150.0	25.9	1,440.0	1810
1151013	185.0	28.2	1,776.0	2184
1151014	240.0	30.3	2,304.0	2757
1151015	300.0	34.0	2,880.0	3407

Unless specified otherwise, the shown product values are nominal values. Detailed values (e.g. tolerances) are available upon request.

Copper price basis: EUR 150/100kg. Refer to Appendix T17 for the definition and calculation of copper-related surcharges.

Please find our standard lengths at: [www.lappkabel.de/en/cable-standardlengths](http://www.lappkabel.de/en/cable-standardlengths)

Packaging size: Drum

Photographs are not to scale and do not represent detailed images of the respective products.

### Similar products

- NSGAFöu 1.8/3 kV refer to page 44

### Accessories

- Tube cable lugs KR/ KRT/ KRF refer to page 121
- Cable shears KT 4 and KT 5 refer to main catalogue 2012 page 904



**Info**

- Torsion-resistant, high mechanical flexibility, flexible at cold temperatures/90 °C(UL)
- Can be used in the cable loop underneath the nacelle
- Salt-water test, UV/ozone-resistant
- Torsion-tested for wind turbines

**Benefits**

- Cost-effective alternative to the halogen-free, highly flame-retardant and enhanced oil-resistant ÖLFLEX® TORSION FRNC version with improved characteristics in the event of a fire
- The special design reliably compensates for the permanent torsional movements inside the wind turbine between the nacelle and the tower
- The high flexibility and good dismantling and stripping properties enable easy space-saving cable installation and fast processing

**Application range**

- For fixed and flexible installations, as well as for applications with torsional movements (e.g. machinery, wind turbines)
- Very suitable for installation in the drip-loop, between the rotating nacelle and the stationary windmill tower, to connect the generator to the control units
- As a torsionally moved cable for use in North America with UL WTTC Listing (Wind Turbine Tray Cable), we recommend ÖLFLEX® FORTIS, which complies with the NFPA 79 standard and UL 2277 and UL 6140 subject

**Product features**

- Torsion-resistant up to ±150°/m
- Flame-retardant according to IEC 60332-1-2, VW-1, FT1
- Flexible at cold temperatures (IEC 60811/VDE 0473-811), 90 °C compounds according to UL
- Oil-resistant according to IEC 60227-1 PVC/ST9, salt-water immersion test according to UL 1309

- UV-resistant according to ISO 4892-2-2006, method A, and ozone-resistant according to EN 50396, method B

**Approvals**



- Use of leading, European metric stranded conductors according to the IEC scale for conductor nominal cross-sections in mm<sup>2</sup> according to IEC 60228/VDE 0295, braided conductor class 6 (tinned): For converting to AWG, odd-numbered nominal AWG cross-sections must be excluded. The next lowest nominal AWG conductor cross-section in mm<sup>2</sup> must then be allocated to the metric nominal conductor cross-section in mm<sup>2</sup> (according to IEC 60228) (please refer to the technical catalogue appendix T16). This is to ensure that the normative current rating defined by the nominal AWG conductor cross-section does not exceed the physical/real current rating defined by the nominal IEC conductor cross-section that is actually used

**Design**

- Extra-fine wire conductor made of bare copper
- Core insulation made of special PVC compound: flexible at cold temperatures according to IEC 60811-1-4/VDE 0473-811-1-4, 90 °C according to UL
- Use of talcum
- Core connection optimised for high torsion requirements, twisted in layers
- Special PVC-based outer sheath: flexible at cold temperatures according to IEC 60811-1-4/VDE 0473-811-1-4, 90 °C according to UL
- Outer sheath colour: black

**ÖLFLEX® TORSION**

Power and control cables for flexible use under torsional load - 0.6/1 kV

LAPP KABEL STUTTGART ÖLFLEX® TORSION CE

**Technical data**

- Core identification code**  
Up to 5 cores: colour-coded according to VDE 0293-308, refer to Appendix T9  
From 6 cores: black with white numbers
- Approvals**  
UL AWM (UL 758): Style 10012 + Style 20886  
cUL AWM I A/B, cUL AWM II A/B (both according to CSA C22.2 No.210-05)
- Based on**  
HD 21.13/VDE 0281-13 and VDE 0250-1  
UL AWM Styles 10012 and 20886 as well as CSA AWM C22.2 No. 210-05
- Specific insulation resistance**  
> 20 GOhm x cm
- Conductor stranding**  
Extra-fine wire acc. to VDE 0295, class 6/IEC 60228 class 6
- Minimum bending radius**  
Flexible use: 10 x outer diameter  
Fixed installation: 6 x outer diameter
- Nominal voltage**  
According to IEC/VDE: U0/U 0.6/1 kV ac  
According to UL/CSA: 1000 V
- Test voltage**  
C/C: 4000 V
- Protective conductor**  
G = with GN-YE protective conductor  
X = without protective conductor
- Temperature range**  
Flexible use: -35°C to +90°C (acc. UL)  
Fixed installation: -40 °C to +90 °C (according to UL)

Article number	Number of cores and mm <sup>2</sup> per conductor	Outer diameter (mm)	Copper index (kg/km)	Weight (kg/km)
<b>ÖLFLEX® TORSION</b>				
1150465	12 G 0.75	12.4	86.4	222.43
1150466	14 G 0.75	13.0	100.8	272.59
1150467	18 G 0.75	14.6	129.6	304.28
1150468	25 G 0.75	17.8	180.0	450.97
1150469	41 G 0.75	22.4	295.2	701
1150470	50 G 0.75	24.2	360.0	835.1
1150479	12 G 1.0	13.2	115.2	258.63
1150480	16 G 1.0	14.8	153.6	368.93
1150485	3 G 1.5	9.0	43.2	122.5
1150486	4 G 1.5	9.7	57.6	146.48
1150487	5 G 1.5	10.6	72.0	172.26
1150488	7 G 1.5	12.6	100.8	238.27
1150489	12 G 1.5	15.3	172.8	365.37
1150490	19 G 1.5	18.3	273.6	530
1150491	25 G 1.5	22.8	360.0	790.84
1150492	32 G 1.5	24.5	460.8	942.4
1150495	3 G 2.5	10.4	72.0	170.45
1150496	4 G 2.5	11.3	96.0	227.87
1150497	5 G 2.5	12.4	120.0	244.65
1150498	7 G 2.5	15.0	168.0	352.26
1150499	12 G 2.5	18.9	288.0	540
1150500	16 G 2.5	20.8	384.0	760
1150501	19 G 2.5	23.9	456.0	879.61
1150502	25 G 2.5	26.8	600.0	1126.58
1150505	3 G 4	11.9	115.2	240.57

Article number	Number of cores and mm <sup>2</sup> per conductor	Outer diameter (mm)	Copper index (kg/km)	Weight (kg/km)
1150506	4 G 4	13.0	153.6	297.57
1150507	5 G 4	14.3	192.0	352.77
1150508	3 G 6	12.9	172.8	322.03
1150509	4 G 6	14.4	230.4	384.49
1150510	5 G 6	16.0	288.0	466.84
1150511	3 G 10	16.6	288.0	530.15
1150512	4 G 10	18.4	384.0	631.48
1150513	5 G 10	20.5	480.0	768.13
1150514	3 G 16	19.2	460.8	794
1150515	4 G 16	22.2	614.4	1017.78
1150516	5 G 16	24.4	768.0	1147.35
1150517	3 G 25	24.5	720.0	1133
1150518	3 X 25	24.5	720.0	1133
1150519	4 G 25	26.9	960.0	1471.23
1150520	5 G 25	29.9	1,200.0	1815.1
1150521	3 G 35	27.1	1,008.0	1521
1150522	3 X 35	27.1	1,008.0	1521
1150523	4 G 35	30.1	1,344.0	1952
1150524	5 G 35	33.7	1,680.0	2438.71
1150525	3 G 50	32.1	1,440.0	2235
1150526	3 X 50	32.1	1,440.0	2235
1150527	4 G 50	35.7	1,920.0	2866
1150528	5 G 50	39.5	2,400.0	3583.23
1150529	3 G 70	37.0	2,016.0	3150
1150530	3 X 70	37.0	2,016.0	3150
1150531	4 G 70	41.4	2,688.0	4112

Unless specified otherwise, the shown product values are nominal values. Detailed values (e.g. tolerances) are available upon request. Copper price basis: EUR 150/100kg. Refer to Appendix T17 for the definition and calculation of copper-related surcharges. Please find our standard lengths at: [www.lappkabel.de/en/cable-standardlengths](http://www.lappkabel.de/en/cable-standardlengths) Packaging size: coil ≤ 30 kg or ≤ 250 m, otherwise drum Details of the clamping force are available upon request, halogen-free. Photographs are not to scale and do not represent detailed images of the respective products.

**Similar products**

- ÖLFLEX® TORSION FRNC refer to main catalogue 2012 page 155
- ÖLFLEX® FORTIS refer to page 40

**Expanded ambient temperatures**

Cross-linked cables (-55 °C to +125 °C)

# ÖLFLEX® HEAT 145 MC

Electron beam cross-linked cables for more demanding application requirements



**Info**

- Improved characteristics in the event of a fire
- Voltage class from 1.5 mm<sup>2</sup> 450/750 V
- Please note: Discontinued product!

**Benefits**

- Reduction of flame propagation and density and toxicity of smoke gases in event of fire
- Minimises damage to buildings and equipment caused by the formation of toxic acid fumes in fires
- Certified for maritime applications

**Application range**

- For the wiring and connection of lighting, heating appliances, control cabinets, and distributors in mechanical and plant engineering
- For use outdoors
- Slip ring – Pitch connection

**Product features**

- Halogen-free according to IEC 60754-1  
Flame-retardant according to IEC 60332-1-2  
No flame propagation according to IEC 60332-3-24 or IEC 60332-3-25
- Good moisture, ozone and UV-resistance
- Abrasion and notch-resistant

**Approvals**



**Design**

- Fine-wire, tinned-copper conductor
- Electron beam cross-linked polyolefin copolymer insulation
- Cores twisted in layers
- Outer sheath: electron beam cross-linked polyolefin copolymer, black

**Technical data**



**Core identification code**

Up to 5 cores: colour-coded according to VDE 0293-308, refer to Appendix T9  
From 7 cores:  
black with white numbers (with gn/ye)



**Approvals**

GL (Germanischer Lloyd)



**Conductor stranding**

Fine wire according to VDE 0295, class 5/  
IEC 60228 class 5 from 0.5 mm<sup>2</sup>



**Minimum bending radius**

Occasional flexing: 15 x outer diameter  
Fixed installation: 4 x outer diameter



**Nominal voltage**

Up to 1.0mm<sup>2</sup> U<sub>0</sub>/U 300/500 V  
From 1.5mm<sup>2</sup> U<sub>0</sub>/U 450/750 V  
0.6/1kV from 1.5 mm<sup>2</sup> in the case of fixed and protected installation



**Test voltage**

3500 V



**Protective conductor**

G = with GN-YE protective conductor  
X = without protective conductor



**Temperature range**

Fixed installation:  
-55 °C to +125 °C  
Short-term: up to +145 °C

Article number	Number of cores and mm <sup>2</sup> per conductor	Outer diameter (mm)	Copper index (kg/km)	Weight (kg/km)
<b>ÖLFLEX® HEAT 145 MC 300/500 V</b>				
0026805	2 X 0.75	5.9	14.4	40
0026806	3 G 0.75	6.2	21.6	53
00268073	4 G 0.75	6.9	28.8	69
00268083	5 G 0.75	7.7	36.0	86
0026815	2 X 1	6.3	19.2	50
0026816	3 G 1	6.8	28.8	67
00268173	4 G 1	7.4	38.4	87
00268183	5 G 1	8.3	48.0	107
0026819	7 G 1	9.9	67.2	152
<b>ÖLFLEX® HEAT 145 MC 450/750 V</b>				
0026825	2 X 1.5	7.6	28.8	71
0026826	3 G 1.5	8.1	43.2	96
00268273	4 G 1.5	8.8	57.6	123
00268293	5 G 1.5	9.8	72.0	156
0026830	7 G 1.5	12.0	101.0	224
0026831	10 G 1.5	14.6	144.0	322
0026832	12 G 1.5	14.6	173.0	316
0026833	16 G 1.5	16.2	230.0	415
0026837	25 G 1.5	21.1	360.0	731
0026838	2 X 2.5	9.0	48.0	102
0026839	3 G 2.5	9.8	72.0	145
00268403	4 G 2.5	10.8	96.0	189
00268413	5 G 2.5	12.0	120.0	235
0026842	7 G 2.5	14.6	168.0	344
00268503	4 G 4	12.2	153.6	276
00268513	5 G 4	13.5	192.0	334
00268563	5 G 6	15.4	288.0	494

Unless specified otherwise, the shown product values are nominal values. Detailed values (e.g. tolerances) are available upon request.

Copper price basis: EUR 150/100kg. Refer to Appendix T17 for the definition and calculation of copper-related surcharges.

Please find our standard lengths at: [www.lappkabel.de/en/cable-standardlengths](http://www.lappkabel.de/en/cable-standardlengths)

Packaging size: coil ≤ 30 kg or ≤ 250 m, otherwise drum

Please specify the preferred type of packaging (e.g. 1 x 500 m drum or 5 x 100 m coils).

Photographs are not to scale and do not represent detailed images of the respective products.

**Similar products**

- ÖLFLEX® TRAFFIC 3GKW flex refer to main catalogue 2012 page 141

**ÖLFLEX® HEAT 145 C MC**

Electron beam cross-linked cables for more demanding application requirements



**Info**

- Improved characteristics in the event of a fire
- Screened to comply with EMC
- Please note: Discontinued product!

**Benefits**

- Reduction of flame propagation and density and toxicity of smoke gases in event of fire
- Minimises damage to buildings and equipment caused by the formation of toxic acid fumes in fires
- Certified for maritime applications
- Copper braiding screens the cable against electromagnetic interference

**Application range**

- For the wiring and connection of lighting, heating appliances, control cabinets, and distributors in mechanical and plant engineering
- For use outdoors
- Slip ring – Pitch connection

**Product features**

- Halogen-free according to IEC 60754-1
- Flame-retardant according to IEC 60332-1-2
- No flame propagation according to IEC 60332-3-24 or IEC 60332-3-25
- Good moisture, ozone and UV-resistance
- Abrasion and notch-resistant

**Approvals**



**Design**

- Fine-wire, tinned-copper conductor
- Electron beam cross-linked polyolefin copolymer insulation
- Cores twisted in layers
- Tinned-copper braiding
- Outer sheath: electron beam cross-linked polyolefin copolymer, black

**Technical data**

- Core identification code**  
Black with white numbers (without gn/ye)
- Approvals**  
GL (Germanischer Lloyd)
- Specific insulation resistance**  
>2 T0hm x cm
- Conductor stranding**  
Fine wire according to VDE 0295, class 5 / IEC 60228 class 5 from 0.5 mm<sup>2</sup>
- Minimum bending radius**  
Occasional flexing: 15 x outer diameter  
Fixed installation: 5 x outer diameter
- Nominal voltage**  
Up to 1.0mm<sup>2</sup> U<sub>0</sub>/U 300/500 V  
From 1.5mm<sup>2</sup> U<sub>0</sub>/U 450/750 V  
0.6/1kV from 1.5 mm<sup>2</sup> in the case of fixed and protected installation
- Test voltage**  
C/C 3500 V  
C/S 2500 V
- Protective conductor**  
G = with GN-YE protective conductor  
X = without protective conductor
- Temperature range**  
Fixed installation:  
-55 °C to +125 °C  
Short-term: up to +145 °C

Article number	Number of cores and mm <sup>2</sup> per conductor	Outer diameter (mm)	Copper index (kg/km)	Weight (kg/km)
<b>ÖLFLEX® HEAT 145 C MC screened 300/500 V</b>				
0026908	2 X 0.75	6.9	38.0	79
0026909	3 X 0.75	6.9	50.0	96
0026910	4 X 0.75	7.6	58.0	116
0026911	5 X 0.75	8.3	70.0	139
0026912	7 X 0.75	9.9	84.9	186
0026916	2 X 1	7.0	43.3	90
0026917	3 X 1	7.4	56.0	104
0026918	4 X 1	8.1	66.0	129
0026919	5 X 1	8.9	95.0	153
0026920	7 X 1	10.5	109.0	211
<b>ÖLFLEX® HEAT 145 C MC screened 450/750 V</b>				
0026924	2 X 1.5	8.2	58.0	114
0026925	3 X 1.5	8.7	71.0	132
0026926	4 X 1.5	9.4	86.0	163
0026927	5 X 1.5	10.5	104.0	200
0026928	7 X 1.5	12.6	136.0	273
0026932	2 X 2.5	9.8	96.0	157
0026933	3 X 2.5	10.4	146.0	198
0026934	4 X 2.5	11.5	150.0	236
0026935	5 X 2.5	12.6	200.0	287
0026938	4 X 4	12.8	220.0	317
0026939	5 X 4	14.3	259.0	376

Unless specified otherwise, the shown product values are nominal values. Detailed values (e.g. tolerances) are available upon request.  
 Copper price basis: EUR 150/100kg. Refer to Appendix T17 for the definition and calculation of copper-related surcharges.  
 Please find our standard lengths at: [www.lappkabel.de/en/cable-standardlengths](http://www.lappkabel.de/en/cable-standardlengths)  
 Packaging size: coil ≤ 30 kg or ≤ 250 m, otherwise drum  
 Please specify the preferred type of packaging (e.g. 1 x 500 m drum or 5 x 100 m coils).  
 Photographs are not to scale and do not represent detailed images of the respective products.

**Similar products**

- ÖLFLEX® TRAFFIC 3GKW C-flex refer to main catalogue 2012 page 142

**Accessories**

- SKINTOP® MS-SC-M refer to page 104
- SKINTOP® MS-SC refer to main catalogue 2012 page 719
- SKINTOP® MS-M BRUSH refer to page 105

# ÖLFLEX® HEAT 180 SiHF

Silicone cables with extended temperature range



Info

- The classic for multi-functional use

### Benefits

- Flexibility simplifies installation where space is limited
- Possesses insulating properties after combustion due to remaining SiO<sub>2</sub> ash on the conductor

### Application range

- Areas with high ambient temperatures where insulating and sheath materials of conventional cables will embrittle after a short while
- Typical fields of application
  - Electric motor industry
  - Thermal and heating elements
  - Lighting technology
- Internal Wiring of Generator`s

### Product features

- Halogen-free and flame-retardant (IEC 60332-1-2)
- Resistant to a multitude of oils, alcohols, vegetable and animal fats, and chemical substances

### Approvals



### Design

- Fine-wire, tinned-copper conductor
- Silicone-based core insulation
- Cores twisted in layers
- Silicone-based outer sheath, colour red-brown

### Technical data

- Core identification code**  
Colours according to VDE 0293-308, refer to Appendix T9  
From 6 cores: black with white numbers
- Specific insulation resistance**  
>200 GOhm x cm
- Conductor stranding**  
Fine wire according to VDE 0295 Class 5/ IEC 60228 Class 5
- Minimum bending radius**  
Occasional flexing: 15 x outer diameter  
Fixed installation: 4 x outer diameter
- Nominal voltage**  
U<sub>0</sub>/U: 300/500 V
- Test voltage**  
2000 V
- Protective conductor**  
G = with GN-YE protective conductor  
X = without protective conductor
- Temperature range**  
-50 °C to +180 °C  
(adequate ventilation required)

Article number	Number of cores and mm² per conductor	Outer diameter (mm)	Copper index (kg/km)	Weight (kg/km)
<b>ÖLFLEX® HEAT 180 SiHF</b>				
0046001	2 X 0.75	6.4	14.4	59
0046002	3 G 0.75	6.8	21.6	70
00460033	4 G 0.75	7.6	28.8	89
00460043	5 G 0.75	8.5	36.0	112
0046005	6 G 0.75	9.2	43.2	131
0046006	7 G 0.75	9.2	50.4	136
0046007	2 X 1	6.6	19.2	66
0046008	3 G 1	7.0	29.0	79
00460093	4 G 1	7.9	38.4	101
00460103	5 G 1	8.8	48.0	127
0046012	7 G 1	9.5	67.0	156
0046013	2 X 1.5	7.6	29.0	90
0046014	3 G 1.5	8.0	43.0	109
00460153	4 G 1.5	8.8	58.0	134
00460163	5 G 1.5	9.6	72.0	163
0046018	7 G 1.5	10.4	101.0	202
0046039	12 G 1.5	14.0	173.0	361
0046040	16 G 1.5	16.2	230.4	478
0046041	20 G 1.5	17.5	288.0	574

Article number	Number of cores and mm² per conductor	Outer diameter (mm)	Copper index (kg/km)	Weight (kg/km)
0046042	24 G 1.5	19.8	345.6	720
0046019	2 X 2.5	8.8	48.0	128
0046020	3 G 2.5	9.7	72.0	167
00460213	4 G 2.5	10.6	96.0	206
00460223	5 G 2.5	11.6	120.0	251
0046024	7 G 2.5	12.6	168.0	313
0046025	2 X 4	10.8	76.8	196
0046026	3 G 4	11.5	115.0	241
00460273	4 G 4	12.6	154.0	300
00460283	5 G 4	14.0	192.0	374
0046030	7 G 4	15.6	269.0	486
0046031	2 X 6	12.4	116.0	268
0046032	3 G 6	13.2	173.0	333
00460333	4 G 6	14.7	230.0	425
00460343	5 G 6	16.6	288.0	538
0046036	7 G 6	18.6	403.0	705
00460373	4 G 10	19.4	384.0	707
00460453	5 G 10	21.6	480.0	878
00460383	4 G 16	21.4	614.0	1004

Unless specified otherwise, the shown product values are nominal values. Detailed values (e.g. tolerances) are available upon request.  
 Copper price basis: EUR 150/100kg. Refer to Appendix T17 for the definition and calculation of copper-related surcharges.  
 Please find our standard lengths at: [www.lappkabel.de/en/cable-standardlengths](http://www.lappkabel.de/en/cable-standardlengths)  
 Packaging size: coil ≤ 30 kg or ≤ 250 m, otherwise drum  
 Please specify the preferred type of packaging (e.g. 1 x 500 m drum or 5 x 100 m coils).  
 Photographs are not to scale and do not represent detailed images of the respective products.

### Similar products

- ÖLFLEX® HEAT 180 H05SS-F EWKF refer to main catalogue 2012 page 176
- ÖLFLEX® HEAT 180 EWKF refer to page 55

ÖLFLEX®

UNITRONIC®

ETHERLINE®

HITRONIC®

EPIC®

SKINTOP®

SILVYN®

FLEXIMARK®

ACCESSORIES

# ÖLFLEX® HEAT 180 MS

Certified silicone cables for North America (AWM recognized)

**Info**

- MS = Multi-Standard  
For use in the USA and Canada
- UL AWM Style 4476 (150°C/600V)



### Benefits

- Certified for the USA and Canada for export-oriented appliance and apparatus manufacturers
- Thicker cable design meets the requirements of the FT-1 flame test and also approved for the external interconnection of apparatuses and appliances
- Flexibility simplifies installation where space is limited
- Possesses insulating properties after combustion due to remaining SiO<sub>2</sub> ash on the conductor

### Application range

- Areas with high ambient temperatures where insulating and sheath materials of conventional cables will embrittle after a short while
- Typical fields of application
  - Electric motor industry
  - Thermal and heating elements
  - Lighting technology
- Internal Wiring of Generator`s (UL)

### Product features

- Metric flexible conductor design
- Halogen-free and flame-retardant (IEC 60332-1-2)
- Good hydrolysis and UV-resistance
- Resistant to a multitude of oils, alcohols, vegetable and animal fats, and chemical substances

### Approvals



- UL AWM 4476 and cUL AWM II A/B
- Special product with AWM rating 200°C/600 Vis available upon request
- Multi-core type AWM cables (Appliance Wiring Material) shall be permitted for industrial machinery (USA) only when part of a listed assembly suitable for the intended use. NFPA 79 Edition 2007 §12.2.7.3

### Design

- Fine-wire, tinned-copper conductor
- Silicone-based core insulation
- Cores twisted together
- Silicone-based outer sheath, colour black (RAL 9005)

### Technical data

- Core identification code**  
Colours according to VDE 0293-308, refer to Appendix T9  
From 6 cores: black with white numbers
- Approvals**  
UL AWM Style 4476 (Construction B)  
cUL AWM II A/B (Canada)
- Conductor stranding**  
Fine wire according to VDE 0295, class 5/IEC 60228 class 5  
(Refer to Appendix T16 for the matching US conductor sizes in AWG standard)
- Minimum bending radius**  
Occasional flexing: 15 x outer diameter  
Fixed installation: 4 x outer diameter
- Nominal voltage**  
U<sub>0</sub>/U: 300/500 V  
Working voltage UL: 600 V
- Test voltage**  
2000 V
- Protective conductor**  
G = with GN-YE protective conductor  
X = without protective conductor
- Temperature range**  
According to VDE: -50 °C to +180 °C  
Normatively acc. to UL Style: up to +150 °C (adequate ventilation required)

Article number	Number of cores and mm <sup>2</sup> per conductor	Outer diameter (mm)	Copper index (kg/km)	Weight (kg/km)
<b>ÖLFLEX® HEAT 180 MS</b>				
0046600	2 X 0.5	7.4	9.8	72
0046601	3 G 0.5	7.8	14.7	83
00466023	4 G 0.5	8.5	19.6	99
00466033	5 G 0.5	9.2	24.5	119
0046604	7 G 0.5	9.9	34.3	142
0046612	2 X 1	8.2	19.2	93
0046613	3 G 1	8.7	28.8	110
00466143	4 G 1	9.4	38.4	133
00466153	5 G 1	10.3	48.0	160
0046616	7 G 1	11.1	67.2	195
0046617	12 G 1	14.9	115.2	345
0046618	2 X 1.5	8.8	28.8	113
0046619	3 G 1.5	9.3	43.2	135
00466203	4 G 1.5	10.1	57.6	165
00466213	5 G 1.5	11.1	72.0	200
0046622	7 G 1.5	12.0	100.8	246
0046623	12 G 1.5	16.1	172.8	437
0046625	18 G 1.5	18.8	259.2	613
0046626	25 G 1.5	22.9	360.0	904
0046628	2 X 2.5	9.6	48.0	146
0046629	3 G 2.5	10.2	72.0	178
00466303	4 G 2.5	11.1	96.0	220
00466313	5 G 2.5	12.2	120.0	269
0046633	3 G 4	11.5	115.2	246
00466343	4 G 4	12.6	153.6	307
00466353	5 G 4	14.2	192.0	389
0046636	3 G 6	14.9	172.8	396
00466373	4 G 6	16.4	230.4	495
00466383	5 G 6	18.0	288.0	608

Unless specified otherwise, the shown product values are nominal values. Detailed values (e.g. tolerances) are available upon request.

Copper price basis: EUR 150/100kg. Refer to Appendix T17 for the definition and calculation of copper-related surcharges.

Please find our standard lengths at: [www.lappkabel.de/en/cable-standardlengths](http://www.lappkabel.de/en/cable-standardlengths)

Packaging size: coil ≤ 30 kg or ≤ 250 m, otherwise drum

Please specify the preferred type of packaging (e.g. 1 x 500 m drum or 5 x 100 m coils).

Photographs are not to scale and do not represent detailed images of the respective products.

### Similar products

- ÖLFLEX® HEAT 180 C MS refer to page 54



**Expanded ambient temperatures**

Silicone cables (-50°C to +180°C)

# ÖLFLEX® HEAT 180 C MS

Screened and approved silicone cables for North America (AWM recognized)



**Info**

- MS = Multi-Standard For use in the USA and Canada
- UL AWM Style 4476 (150°C/600V)
- EMC compliant copper screening

**Benefits**

- Certified for the USA and Canada for export-oriented appliance and apparatus manufacturers
- Thicker cable design meets the requirements of the FT-1 flame test and also approved for the external interconnection of apparatuses and appliances
- Flexibility simplifies installation where space is limited
- Copper braiding screens the cable against electromagnetic interference

**Application range**

- Areas with high ambient temperatures where insulating and sheath materials of conventional cables will embrittle after a short while
- Typical fields of application
  - Electric motor industry
  - Thermal and heating elements
  - Lighting technology

**Product features**

- Metric flexible conductor design
- Halogen-free and flame-retardant (IEC 60332-1-2)
- Good hydrolysis and UV-resistance
- Resistant to a multitude of oils, alcohols, vegetable and animal fats, and chemical substances

**Approvals**



- UL AWM 4476 and cUL AWM II A/B
- Special product with AWM rating 200°C/600 V is available upon request
- Multi-core type AWM cables (Appliance Wiring Material) shall be permitted for industrial machinery (USA) only when part of a listed assembly suitable for the intended use. NFPA 79 Edition 2007 §12.2.7.3

**Design**

- Fine-wire, tinned-copper conductor
- Silicone-based core insulation
- Cores twisted together
- Tinned-copper screen braiding, interleaved plastic foil wrapping
- Silicone-based outer sheath, colour black (RAL 9005)

**Technical data**

**Core identification code**  
Colours according to VDE 0293-308, refer to Appendix T9  
From 6 cores: black with white numbers

**Approvals**  
UL AWM Style 4476 (Construction B)  
cUL AWM II A/B (Canada)

**Specific insulation resistance**  
>200 GOhm x cm

**Conductor stranding**  
Fine wire according to VDE 0295, class 5/IEC 60228 class 5  
(Refer to Appendix T16 for the matching US conductor sizes in AWG standard)

**Minimum bending radius**  
Occasional flexing: 20 x outer diameter  
Fixed installation: 6 x outer diameter

**Nominal voltage**  
U<sub>c</sub>/U: 300/500 V  
Working voltage UL: 600 V

**Test voltage**  
2000 V

**Protective conductor**  
G = with GN-YE protective conductor  
X = without protective conductor

**Temperature range**  
According to VDE: -50 °C to +180 °C  
Normatively acc. to UL Style: up to +150 °C (adequate ventilation required)

Article number	Number of cores and mm <sup>2</sup> per conductor	Outer diameter (mm)	Copper index (kg/km)	Weight (kg/km)
<b>ÖLFLEX® HEAT 180 C MS</b>				
0046701	3 G 0.5	8.6	43.4	100
0046702	4 G 0.5	9.3	55.4	122
0046703	5 G 0.5	10.0	60.2	137
0046708	2 X 1	9.0	48.2	104
0046709	3 G 1	9.5	65.0	131
0046710	4 G 1	10.2	74.6	152
0046711	5 G 1	11.0	91.5	181
0046712	7 G 1	11.9	117.9	228
0046716	2 X 1.5	9.6	65.0	126
0046717	3 G 1.5	10.1	79.4	152
0046718	4 G 1.5	10.9	101.1	186
0046719	5 G 1.5	11.8	122.7	222
0046720	7 G 1.5	12.8	158.7	281
0046721	12 G 1.5	16.9	245.2	431
0046723	18 G 1.5	19.6	346.1	600
0046724	25 G 1.5	23.9	495.7	833
0046728	3 G 2.5	11.0	115.5	197
0046729	4 G 2.5	11.9	146.7	244
0046730	5 G 2.5	12.9	177.9	291
0046734	3 G 4	12.3	165.9	261
0046735	4 G 4	13.4	211.5	325
0046736	5 G 4	14.9	257.2	389
0046740	4 G 6	17.2	302.8	482
0046741	5 G 6	18.7	367.6	580
0046742	4 G 10	22.8	508.4	802

Unless specified otherwise, the shown product values are nominal values. Detailed values (e.g. tolerances) are available upon request.  
 Copper price basis: EUR 150/100kg. Refer to Appendix T17 for the definition and calculation of copper-related surcharges.  
 Please find our standard lengths at: [www.lappkabel.de/en/cable-standardlengths](http://www.lappkabel.de/en/cable-standardlengths)  
 Packaging size: coil ≤ 30 kg or ≤ 250 m, otherwise drum  
 Please specify the preferred type of packaging (e.g. 1 x 500 m drum or 5 x 100 m coils).  
 Photographs are not to scale and do not represent detailed images of the respective products.

**Similar products**

- ÖLFLEX® HEAT 180 MS refer to page 53
- ÖLFLEX® HEAT 180 EWK C refer to main catalogue 2012 page 180

ÖLFLEX®  
 UNITRONIC®  
 ETHERLINE®  
 HITRONIC®  
 EPIC®  
 SKINTOP®  
 SILVYN®  
 FLEXIMARK®  
 ACCESSORIES

# ÖLFLEX® HEAT 180 EWKF

Silicone cables with increased mechanical characteristics

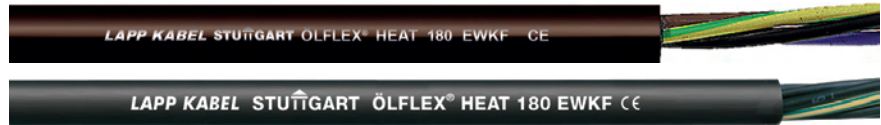

**Info**

- Proven notch-resistant EWKF quality

**Benefits**

- Longer durability in harsh applications than conventional silicone cables
- Notch and tear-resistant silicone compounds reduce damage due to mechanical stress
- Due to the use of special additives in EWKF silicone, armoured cable versions will not be required
- Flexibility simplifies installation where space is limited
- Possesses insulating properties after combustion due to remaining SiO<sub>2</sub> ash on the conductor

**Application range**

- Areas with high ambient temperatures and very high mechanical stress
- Typical fields of application
  - Electric motor industry
  - Thermal and heating elements
  - Lighting technology

**Product features**

- Halogen-free and flame-retardant (IEC 60332-1-2)
- Good hydrolysis and UV-resistance
- Resistant to a multitude of oils, alcohols, vegetable and animal fats, and chemical substances
- EWKF:** Increased initial tear propagation and notch resistance

**Approvals**



**Design**

- Fine-wire, tinned-copper conductor
- Core insulation: based on EWKF silicone
- Cores twisted together
- Outer sheath: silicone-based EWKF, notch-resistant, black (RAL 9005)

**Technical data**

- Core identification code**  
Colours according to VDE 0293-308, refer to Appendix T9  
From 6 cores: black with white numbers
- Specific insulation resistance**  
>200 GOhm x cm
- Conductor stranding**  
Fine wire according to VDE 0295 Class 5 / IEC 60228 Class 5
- Minimum bending radius**  
Occasional flexing: 15 x outer diameter  
Fixed installation: 4 x outer diameter
- Nominal voltage**  
U<sub>0</sub>/U: 300/500 V
- Test voltage**  
2000 V
- Protective conductor**  
G = with GN-YE protective conductor  
X = without protective conductor
- Temperature range**  
-50 °C to +180 °C  
(adequate ventilation required)

Article number	Number of cores and mm <sup>2</sup> per conductor	Outer diameter (mm)	Copper index (kg/km)	Weight (kg/km)
<b>ÖLFLEX® HEAT 180 EWKF</b>				
0046500	2 X 0.75	6.4	15.0	49
0046501	3 G 0.75	6.9	22.0	60
00465023	4 G 0.75	7.6	29.0	76
00465033	5 G 0.75	8.5	36.0	96
0046506	2 X 1	6.8	20.0	56
0046507	3 G 1	7.1	29.0	68
00465083	4 G 1	7.9	39.0	88
00465093	5 G 1	8.8	48.0	110
0046110	7 G 1	9.5	67.2	137
0046511	2 X 1.5	8.0	29.0	77
0046512	3 G 1.5	8.4	43.0	94
00465133	4 G 1.5	9.5	58.0	117
00465143	5 G 1.5	10.4	72.0	143
0046115	7 G 1.5	11.0	101.0	180
0046116	12 G 1.5	14.9	173.0	319
0046117	16 G 1.5	17.1	230.4	424
0046119	24 G 1.5	21.0	345.6	637
0046520	2 X 2.5	9.4	48.0	110
0046521	3 G 2.5	9.8	72.0	146
00465223	4 G 2.5	11.1	96.0	181
00465233	5 G 2.5	12.4	120.0	222
0046131	3 G 4	11.5	114.0	213
00461323	4 G 4	12.5	152.0	267
00461333	5 G 4	13.9	190.0	334
0046141	3 G 6	13.2	174.0	297
00461423	4 G 6	14.7	232.0	381
00461433	5 G 6	16.5	290.0	481

Unless specified otherwise, the shown product values are nominal values. Detailed values (e.g. tolerances) are available upon request.  
 Copper price basis: EUR 150/100kg. Refer to Appendix T17 for the definition and calculation of copper-related surcharges.  
 Please find our standard lengths at: [www.lappkabel.de/en/cable-standardlengths](http://www.lappkabel.de/en/cable-standardlengths)  
 Packaging size: coil ≤ 30 kg or ≤ 250 m, otherwise drum  
 Please specify the preferred type of packaging (e.g. 1 x 500 m drum or 5 x 100 m coils).  
 Photographs are not to scale and do not represent detailed images of the respective products.

**Similar products**

- ÖLFLEX® HEAT 180 H05SS-F EWKF refer to main catalogue 2012 page 176
- ÖLFLEX® HEAT 180 EWKF C refer to main catalogue 2012 page 180

# H05V-K



**Benefits**

- Time-saving assembly

**Application range**

- Internal wiring of devices
- Protected installation in and on lighting equipments
- Signal systems in and on plaster in tubes

**Product features**

- Flame-retardant according to IEC 60332-1-2
- Spool: d1 = 18 mm; d2 = 200 mm; b = 85 mm

**Design**

- Fine-wire strand made of bare copper wires
- Core insulation: Based on PVC

**Technical data**

**Approvals**  
 DIN VDE HD 21/VDE 0281

**Specific insulation resistance**  
 > 20 GOhm x cm

**Conductor stranding**  
 Fine wire according to VDE 0295 Class 5 / IEC 60228 Class 5

**Minimum bending radius**  
 At a cable temperature of 20°C ± 10°C, according to HD 516  
 4 x outer diameter (OD) for normal use; 2 x OD for cautions bending

**Nominal voltage**  
 U<sub>0</sub>/U: 300/500 V

**Test voltage**  
 2000 V

**Current rating**  
 VDE 0298 Part 4  
 HD 516/VDE 0298-300

**Temperature range**  
 Fixed installation:  
 -30°C to +80°C

Conductor cross-section (mm <sup>2</sup> )	Outer diameter (mm)	m/coil	m/spool	Copper index (kg/km)	Weight (kg/km)	Green/yellow	black	blue	Dark blue	brown
0.5	2.5	100		4.8	9	4510001	4510011	4510021	4510141	4510031
0.75	2.7	100		7.2	12	4510002	4510012	4510022	4510142	4510032
1	2.8	100		9.6	15	4510003	4510013	4510023	4510143	4510033
0.5	2.5		250	4.8	9	4510001S	4510011S	4510021S	4510141S	4510031S
0.75	2.7		250	7.2	12	4510002S	4510012S	4510022S	4510142S	4510032S
1	2.8		250	9.6	15	4510003S	4510013S	4510023S	4510143S	4510033S

Conductor cross-section (mm <sup>2</sup> )	Outer diameter (mm)	m/coil	m/spool	Copper index (kg/km)	Weight (kg/km)	yellow	green	violet	Pink	orange
0.5	2.5	100		4.8	9	4510111	4510121	4510071	4510081	4510091
0.75	2.7	100		7.2	12	4510112	4510122	4510072	4510082	4510092
1	2.8	100		9.6	15	4510113	4510123	4510073	4510083	4510093
0.5	2.5		250	4.8	9	4510111S	4510121S	4510071S	4510081S	4510091S
0.75	2.7		250	7.2	12	4510112S	4510122S	4510072S	4510082S	4510092S
1	2.8		250	9.6	15	4510113S	4510123S	4510073S	4510083S	4510093S

Conductor cross-section (mm <sup>2</sup> )	Outer diameter (mm)	m/coil	m/spool	Copper index (kg/km)	Weight (kg/km)	Transparent	red	white	grey	ultra-marine blue
0.5	2.5	100		4.8	9	4510101	4510041	4510051	4510061	4510161
0.75	2.7	100		7.2	12	4510102	4510042	4510052	4510062	
1	2.8	100		9.6	15	4510103	4510043	4510053	4510063	4510163
0.5	2.5		250	4.8	9	4510101S	4510041S	4510051S	4510061S	4510161S
0.75	2.7		250	7.2	12	4510102S	4510042S	4510052S	4510062S	4510162S
1	2.8		250	9.6	15	4510103S	4510043S	4510053S	4510063S	4510163S

Conductor cross-section (mm <sup>2</sup> )	Outer diameter (mm)	m/coil	Copper index (kg/km)	Weight (kg/km)	Dark blue/white
0.5	2.5	100	4.8	9	4510921
0.75	2.7	100	7.2	12	4510922
1	2.8	100	9.6	15	4510923

Unless specified otherwise, the shown product values are nominal values. Detailed values (e.g. tolerances) are available upon request.  
 Copper price basis: EUR 150/100kg. Refer to Appendix T17 for the definition and calculation of copper-related surcharges.  
 Photographs are not to scale and do not represent detailed images of the respective products.



**H07V-K**

**Technical data**

**Approvals**  
DIN VDE HD 21/VDE 0281

**Specific insulation resistance**  
> 20 GOhm x cm

**Conductor stranding**  
Fine wire according to VDE 0295 Class 5/ IEC 60228 Class 5

**Minimum bending radius**  
At a cable temperature of 20°C ± 10°C, according to HD 516  
OD ≤ 8 mm: 4 x OD\*/2 x OD\*\* ; 8 < OD ≤ 12 mm: 5 x OD\*/3 x OD\*\* ; OD > 12 mm: 6 x OD\*/4 x OD\*\*

**Nominal voltage**  
U<sub>0</sub>/U: 450/750 V

**Test voltage**  
2500 V

**Current rating**  
VDE 0298 Part 4  
HD 516/VDE 0298-300

**Temperature range**  
Fixed installation:  
-30°C to +80°C

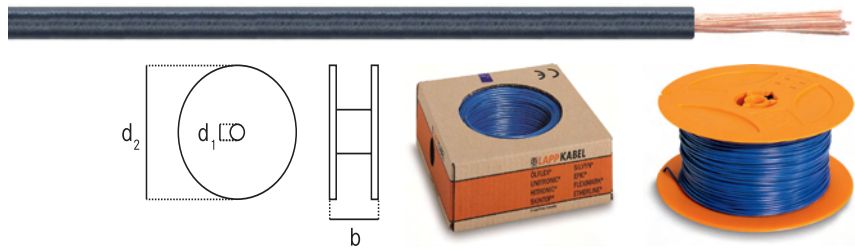

**Benefits**

- Time-saving assembly

**Application range**

- Laying in tubes, exposed or buried in plaster, and in closed installation ducts
- For direct laying on racks, troughs and tubes only as potential equalisation conductor

**Product features**

- Flame-retardant according to IEC 60332-1-2
- Spool: d1 = 18 mm; d2 = 200 mm; b = 85 mm

**Design**

- Fine-wire strand made of bare copper wires
- Core insulation: Based on PVC

Conductor cross-section (mm <sup>2</sup> )	Outer diameter (mm)	m/coil	m/spool	Copper index (kg/km)	Weight (kg/km)	Green/yellow	black	blue	Dark blue	brown
1.5	3.4		150	14.4	22	4520001S	4520011S	4520021S	4520141S	4520031S
2.5	4.1		100	24.0	37	4520002S	4520012S	4520022S	4520142S	4520032S
1.5	3.4	100		14.4	22	4520001	4520011	4520021	4520141	4520031
2.5	4.1	100		24.0	37	4520002	4520012	4520022	4520142	4520032
4	4.8	100		38.4	45	4520003	4520013	4520023	4520143	4520033
6	5.3	100		57.6	71	4520004	4520014	4520024	4520144	4520034
10	6.8	100		96.0	120	4520005	4520015	4520025	4520145	4520035
16	8.1			153.6	187	4520006	4520016	4520026	4520146	4520036
25	10.2			240.0	290	4521001	4521011	4521021	4521141	4521031
35	11.7			336.0	399	4521002	4521012	4521022	4521142	4521032
50	13.9			480.0	559	4521003	4521013	4521023		4521033
70	16.0			672.0	776	4521004	4521014	4521024		4521034
95	18.2			912.0	1031	4521005	4521015	4521025		
120	20.2			1,152.0	1285	4521006	4521016	4521026		
150	22.5			1,440.0	1563	4521007	4521017			
185	24.9			1,776.0	1915	4521008	4521018	4521028		
240	28.4			2,304.0	2550	4521009	4521019			

Conductor cross-section (mm <sup>2</sup> )	Outer diameter (mm)	m/coil	m/spool	Copper index (kg/km)	Weight (kg/km)	yellow	green	violet	Pink	orange
1.5	3.4		150	14.4	22	4520111S	4520121S	4520071S		4520091S
2.5	4.1		100	24.0	37	4520112S	4520122S			4520092S
1.5	3.4	100		14.4	22	4520111	4520121	4520071	4520081	4520091
2.5	4.1	100		24.0	37	4520112	4520122	4520072	4520082	4520092
4	4.8	100		38.4	45	4520113	4520123	4520073		4520093
6	5.3	100		57.6	71	4520114	4520124	4520074		4520094
10	6.8	100		96.0	120		4520125	4520075		4520095
16	8.1			153.6	187		4520126	4520076		4520096
25	10.2			240.0	290		4521121			4521091
35	11.7			336.0	399		4521122			4521092
50	13.9			480.0	559					4521093

Conductor cross-section (mm <sup>2</sup> )	Outer diameter (mm)	m/coil	m/spool	Copper index (kg/km)	Weight (kg/km)	red	white	grey	ultra-marine blue
1.5	3.4		150	14.4	22	4520041S	4520051S	4520061S	
2.5	4.1		100	24.0	37	4520042S	4520052S	4520062S	
1.5	3.4	100		14.4	22	4520041	4520051	4520061	4520161
2.5	4.1	100		24.0	37	4520042	4520052	4520062	4520162
4	4.8	100		38.4	45	4520043	4520053	4520063	4520163
6	5.3	100		57.6	71	4520044	4520054	4520064	4520164
10	6.8	100		96.0	120	4520045	4520055	4520065	4520165
16	8.1			153.6	187	4520046	4520056	4520066	4520166
25	10.2			240.0	290	4521041	4521051	4521061	
35	11.7			336.0	399	4521042		4521062	
50	13.9			480.0	559	4521043		4521063	
70	16.0			672.0	776	4521044			
120	20.2			1,152.0	1285	4521046			4521166

Unless specified otherwise, the shown product values are nominal values. Detailed values (e.g. tolerances) are available upon request.

Copper price basis: EUR 150/100kg. Refer to Appendix T17 for the definition and calculation of copper-related surcharges.

Packaging size: Coil ≤ 30 kg, otherwise drum

Photographs are not to scale and do not represent detailed images of the respective products.

\*for conventional use, \*\*for careful bending; "OD" = outer diameter

- Similar products**
- Multi-Standard SC 2.1 refer to page 58
  - Multi-Standard SC 2.2 refer to main catalogue 2012 page 206

- Accessories**
- Mobile crimp tool crimping pliers refer to main catalogue 2012 page 931
  - DIN-assorted boxes conductor end sleeves refer to main catalogue 2012 page 913
  - PEW 8.87 crimping pliers refer to main catalogue 2012 page 916
  - FLEXIMARK® Collar Snap-on refer to main catalogue 2012 page 856

# Multi-Standard SC 2.1

USA: UL-listed (MTW), Canada: CSA (TEW), Europe: <HAR> H07V-K (depending on cross s.), tin-coated strands

## Multi-Standard SC 2.1

### Benefits

- For use in the most important global markets
- Reduction in technical documentation
- Easier storage; increases the cost-effectiveness of the production process
- Works with "Conductor end sleeves XL, insulated"
- <HAR> H07V-K type-compliant versions (not 0.5 mm<sup>2</sup>, 0.75 mm<sup>2</sup> or 1 mm<sup>2</sup> according to HD 21.3/VDE 0281-3; not 16 mm<sup>2</sup> according to internal technical specification at Lapp; no two-tone core insulation except green-yellow according to HD 21.1/VDE 0281-1) <HAR>-certified with "<HAR>" testing and certification mark for accelerated granting of approvals if final application of cable is within the European CENELEC area; separate testing mark: by UL for design certifications according to the UL standards UL AWM (according to UL 758) and (UL) MTW (according to UL 1063) and by the CSA for design certification according to the CSA standard CSA TEW (according to C22.2 No. 127)

### Application range

- Factory wiring
- Field wiring
- Internal wiring of devices
- Control cabinet wiring

### Product features

- Flame-retardant according to IEC 60332-1-2
- Flame-retardant according to UL VW1/CSA FT1
- Oil-resistant

### Approvals



- Compliant with NFPA 79 Edition 2007
- Multi-standard cables have conductor strands with nominal sizes in mm<sup>2</sup> or AWG/kcmil. The master size is mentioned in the table below, while the equivalent size of the other system can be found in the Appendix T 16 of this catalogue. For this related secondary size the cross-section of the conductor mostly works out to be greater than the specified nominal value.
- Detailed information about the approvals can be found in the "Technical data" box

### Design

- Fine-wire strand made of tinned-copper wires
- Special PVC-based core insulation
- No outer sheath, no nylon jacket, no outer wrapping



### Info

- The all-rounder for many markets

### Technical data



#### Approvals

H07V-K: HD 21/VDE 0281; UL AWM (according to UL 758) Style 1015 (UL AWM file number of U.I. Lapp GmbH: E63634); (UL) MTW (according to UL 1063) ((UL) MTW file number of U.I. Lapp GmbH: E198296); CSA TEW (according to C22.2 No. 127)



#### Specific insulation resistance

> 10 GOhm x cm



#### Conductor stranding

Fine wire according to VDE 0295 Class 5 / IEC 60228 Class 5



#### Minimum bending radius

OD ≤ 8 mm: 4 x OD\* / 2 x OD\*\* ; 8 < OD ≤ 12 mm: 5 x OD\* / 3 x OD\*\* ; OD > 12 mm: 6 x OD\* / 4 x OD\*\*



#### Nominal voltage

HAR / IEC: U<sub>0</sub>/U: 450/750 V; UL (AWM): U: 600 V; UL (MTW): U: 600 V; CSA (TEW): U: 600 V



#### Test voltage

2500 V



#### Temperature range

Fixed installation: HAR/IEC: -40°C to +70°C; UL (AWM): -40°C to +105°C; UL (MTW): -40°C to +90°C; CSA (TEW): -40°C to +105°C

Conductor cross-section (mm <sup>2</sup> )	Outer diameter (mm)	m/coil	m/box	Copper index (kg/km)	Weight (kg/km)	Green/yellow	black	blue	Dark blue
0.5	2.7	100		4.8	10	4160100	4160101	4160102	4160114
0.5	2.7		3,000	4.8	10	4160100K	4160101K	4160102K	4160114K
0.75	2.9	100		7.2	13	4160200	4160201	4160202	4160214
0.75	2.9		2,500	7.2	13	4160200K	4160201K	4160202K	4160214K
1	3.1	100		9.6	16	4160300	4160301	4160302	4160314
1	3.1		2,000	9.6	16	4160300K	4160301K	4160302K	4160314K
1.5	3.4	100		14.4	22	4160400	4160401	4160402	4160414
1.5	3.4		1,500	14.4	22	4160400K	4160401K	4160402K	4160414K
2.5	4.0	100		24.0	37	4160500	4160501	4160502	4160514
2.5	4.0		900	24.0	37	4160500K	4160501K	4160502K	4160514K
4	4.6	100		38.4	45	4160600	4160601	4160602	4160614
4	4.6		600	38.4	45	4160600K	4160601K	4160602K	4160614K
6	5.1	100		57.6	71	4160700	4160701	4160702	4160714
6	5.1		400	57.6	71	4160700K	4160701K	4160702K	4160714K
10	6.8	100		96.0	120	4160800	4160801	4160802	4160814
16	9.0	100		153.6	187	4160900	4160901	4160902	4160914
25	10.2	100		240.0	290	4161000	4161001	4161002	4161014
35	11.7			336.0	399	4161100	4161101	4161102	
50	13.9			480.0	559	4161200	4161201	4161202	
70	16.0			672.0	776	4161300	4161301	4161302	
95	18.2			912.0	1031	4161400	4161401	4161402	
120	19.8			1,152.0	1285	4161500	4161501	4161502	

Conductor cross-section (mm <sup>2</sup> )	Outer diameter (mm)	m/coil	m/box	Copper index (kg/km)	Weight (kg/km)	brown	yellow	green	violet
0.5	2.7	100		4.8	10	4160103	4160110	4160111	4160107
0.5	2.7		3,000	4.8	10	4160103K	4160110K	4160111K	4160107K
0.75	2.9	100		7.2	13	4160203	4160210	4160211	4160207
0.75	2.9		2,500	7.2	13	4160203K	4160210K	4160212K	4160207K
1	3.1	100		9.6	16	4160303	4160310	4160311	4160307
1	3.1		2,000	9.6	16	4160303K	4160310K	4160311K	4160307K
1.5	3.4	100		14.4	22	4160403	4160410	4160411	4160407
1.5	3.4		1,500	14.4	22	4160403K	4160410K	4160412K	4160407K
2.5	4.0	100		24.0	37	4160503	4160510	4160511	4160507
2.5	4.0		900	24.0	37	4160503K	4160510K	4160511K	4160507K
4	4.6	100		38.4	45	4160603	4160610	4160611	4160607
4	4.6		600	38.4	45	4160603K	4160610K	4160612K	4160607K
6	5.1	100		57.6	71	4160703	4160710	4160711	4160707
6	5.1		400	57.6	71	4160703K	4160710K	4160712K	4160707K
10	6.8	100		96.0	120	4160803	4160810	4160811	
16	9.0	100		153.6	187	4160903	4160910	4160911	
25	10.2	100		240.0	290	4161003	4161010	4161011	
35	11.7			336.0	399		4161110	4161111	
50	13.9			480.0	559		4161210	4161211	
70	16.0			672.0	776		4161310	4161311	

Conductor cross-section (mm <sup>2</sup> )	Outer diameter (mm)	m/coil	m/box	Copper index (kg/km)	Weight (kg/km)	Pink	orange	Transparent	red
0.5	2.7	100		4.8	10	4160108	4160109		4160104
0.5	2.7		3,000	4.8	10	4160108K	4160109K	4180651K	4160104K
0.75	2.9	100		7.2	13	4160208	4160209		4160204
0.75	2.9		2,500	7.2	13	4160208K	4160209K	4180652K	4160204K
1	3.1	100		9.6	16	4160308	4160309		4160304
1	3.1		2,000	9.6	16	4160308K	4160309K	4180653K	4160304K
1.5	3.4	100		14.4	22	4160408	4160409		4160404
1.5	3.4		1,500	14.4	22	4160408K	4160409K	4180654K	4160404K
2.5	4.0	100		24.0	37		4160509		4160504
2.5	4.0		900	24.0	37	4160508K	4160509K	4180655K	4160504K
4	4.6	100		38.4	45		4160609		4160604
4	4.6		600	38.4	45	4160608K	4160609K	4180656K	4160604K
6	5.1	100		57.6	71		4160709		4160704
6	5.1		400	57.6	71	4160708K	4160709K	4180657K	4160704K
10	6.8	100		96.0	120		4160809		4160804
16	9.0	100		153.6	187		4160909		4160904
25	10.2	100		240.0	290		4161009		4161004
35	11.7			336.0	399		4161109		4161104

Conductor cross-section (mm <sup>2</sup> )	Outer diameter (mm)	m/coil	m/box	Copper index (kg/km)	Weight (kg/km)	white	grey
0.5	2.7	100		4.8	10	4160105	4160106
0.5	2.7		3,000	4.8	10	4160105K	4160106K
0.75	2.9	100		7.2	13	4160205	4160206
0.75	2.9		2,500	7.2	13	4160205K	4160206K
1	3.1	100		9.6	16	4160305	4160306
1	3.1		2,000	9.6	16	4160305K	4160306K
1.5	3.4	100		14.4	22	4160405	4160406
1.5	3.4		1,500	14.4	22	4160405K	4160406K
2.5	4.0	100		24.0	37	4160505	4160506
2.5	4.0		900	24.0	37	4160505K	4160506K
4	4.6	100		38.4	45	4160605	4160606
4	4.6		600	38.4	45	4160605K	4160606K
6	5.1	100		57.6	71	4160705	4160706
6	5.1		400	57.6	71	4160705K	4160706K
10	6.8	100		96.0	120	4160805	4160806
16	9.0	100		153.6	187	4160905	4160906
25	10.2	100		240.0	290	4161005	4161006
35	11.7			336.0	399	4161105	4161106
70	16.0			672.0	776		4161306
95	18.2			912.0	1031		4161406
120	19.8			1,152.0	1285	4161505	

Conductor cross-section (mm <sup>2</sup> )	Outer diameter (mm)	m/box	Copper index (kg/km)	Weight (kg/km)	ultra-marine blue	Dark blue/white
0.5	2.7	3,000	4.8	10	4160116K	4160192K
0.75	2.9	2,500	7.2	13	4160216K	4160292K
1	3.1	2,000	9.6	16	4160316K	4160392K
1.5	3.4	1,500	14.4	22	4160416K	4160492K
2.5	4.0	900	24.0	37	4160516K	4160592K
4	4.6	600	38.4	45	4160616K	4160692K
6	5.1	400	57.6	71	4160716K	4160792K

Conductor cross-section (mm <sup>2</sup> )	Outer diameter (mm)	m/box	Copper index (kg/km)	Weight (kg/km)	black/green	black/red
0.5	2.7	3,000	4.8	10	4160120K	4160121K
0.75	2.9	2,500	7.2	13	4160220K	4160221K
1	3.1	2,000	9.6	16	4160320K	4160321K
1.5	3.4	1,500	14.4	22	4160420K	4160421K
2.5	4.0	900	24.0	37	4160520K	4160521K
4	4.6	600	38.4	45	4160620K	4160621K
6	5.1	400	57.6	71	4160720K	4160721K

Conductor cross-section (mm <sup>2</sup> )	Outer diameter (mm)	m/box	Copper index (kg/km)	Weight (kg/km)	blue/black	blue/green
0.5	2.7	3,000	4.8	10	4160123K	4160124K
0.75	2.9	2,500	7.2	13	4160223K	4160224K
1	3.1	2,000	9.6	16	4160323K	4160324K
1.5	3.4	1,500	14.4	22	4160423K	4160424K
2.5	4.0	900	24.0	37	4160523K	4160524K
4	4.6	600	38.4	45	4160623K	4160624K
6	5.1	400	57.6	71	4160723K	4160724K

Conductor cross-section (mm <sup>2</sup> )	Outer diameter (mm)	m/coil	m/box	Copper index (kg/km)	Weight (kg/km)	blue/red	blue/white
0.5	2.7	100		4.8	10		4160126
0.5	2.7		3,000	4.8	10	4160125K	4160126K
0.75	2.9	100		7.2	13		4160226
0.75	2.9		2,500	7.2	13	4160225K	4160226K
1	3.1	100		9.6	16		4160326
1	3.1		2,000	9.6	16	4160325K	4160326K
1.5	3.4	100		14.4	22		4160426
1.5	3.4		1,500	14.4	22	4160425K	4160426K
2.5	4.0	100		24.0	37		4160526
2.5	4.0		900	24.0	37	4160525K	4160526K
4	4.6	100		38.4	45		4160626
4	4.6		600	38.4	45	4160625K	4160626K
6	5.1	100		57.6	71		4160726
6	5.1		400	57.6	71	4160725K	4160726K
10	6.8	100		96.0	120		4160826

Control Cabinet Single Cores

Harmonised and approved

Conductor cross-section (mm <sup>2</sup> )	Outer diameter (mm)	m/box	Copper index (kg/km)	Weight (kg/km)	brown/black	brown/white
0.5	2.7	3,000	4.8	10	4160127K	4160129K
0.75	2.9	2,500	7.2	13	4160227K	4160229K
1	3.1	2,000	9.6	16	4160327K	4160329K
1.5	3.4	1,500	14.4	22	4160427K	4160429K
2.5	4.0	900	24.0	37	4160527K	4160529K
4	4.6	600	38.4	45	4160627K	4160629K
6	5.1	400	57.6	71	4160727K	4160729K

Conductor cross-section (mm <sup>2</sup> )	Outer diameter (mm)	m/box	Copper index (kg/km)	Weight (kg/km)	yellow-red	green-white
0.5	2.7	3,000	4.8	10	4160131K	4160134K
0.75	2.9	2,500	7.2	13	4160231K	
1	3.1	2,000	9.6	16	4160331K	
1.5	3.4	1,500	14.4	22	4160431K	
2.5	4.0	900	24.0	37	4160531K	
4	4.6	600	38.4	45	4160631K	
6	5.1	400	57.6	71	4160731K	

Conductor cross-section (mm <sup>2</sup> )	Outer diameter (mm)	m/box	Copper index (kg/km)	Weight (kg/km)	violet-yellow	violet-white
0.5	2.7	3,000	4.8	10	4160136K	4160137K
0.75	2.9	2,500	7.2	13	4160236K	4160237K
1	3.1	2,000	9.6	16	4160336K	4160337K
1.5	3.4	1,500	14.4	22	4160436K	4160437K
2.5	4.0	900	24.0	37	4160536K	4160537K
4	4.6	600	38.4	45	4160636K	4160637K
6	5.1	400	57.6	71	4160736K	4160737K

Conductor cross-section (mm <sup>2</sup> )	Outer diameter (mm)	m/box	Copper index (kg/km)	Weight (kg/km)	orange-black	orange-white
0.5	2.7	3,000	4.8	10	4160138K	4160139K
0.75	2.9	2,500	7.2	13	4160238K	4160239K
1	3.1	2,000	9.6	16	4160338K	4160339K
1.5	3.4	1,500	14.4	22	4160438K	4160439K
2.5	4.0	900	24.0	37	4160538K	4160539K
4	4.6	600	38.4	45	4160638K	4160639K
6	5.1	400	57.6	71	4160738K	4160739K

Conductor cross-section (mm <sup>2</sup> )	Outer diameter (mm)	m/box	Copper index (kg/km)	Weight (kg/km)	red-black	red-yellow
0.5	2.7	3,000	4.8	10	4160140K	4160141K
0.75	2.9	2,500	7.2	13	4160240K	4160241K
1	3.1	2,000	9.6	16	4160340K	4160341K
1.5	3.4	1,500	14.4	22	4160440K	4160441K
2.5	4.0	900	24.0	37	4160540K	4160541K
4	4.6	600	38.4	45	4160640K	4160641K
6	5.1	400	57.6	71	4160740K	4160741K

Conductor cross-section (mm <sup>2</sup> )	Outer diameter (mm)	m/coil	m/box	Copper index (kg/km)	Weight (kg/km)	red-white	white-blue
0.5	2.7	100		4.8	10		4160144
0.5	2.7		3,000	4.8	10	4160142K	4160144K
0.75	2.9	100		7.2	13		4160244
0.75	2.9		2,500	7.2	13	4160242K	4160244K
1	3.1	100		9.6	16		4160344
1	3.1		2,000	9.6	16	4160342K	4160344K
1.5	3.4	100		14.4	22		4160444
1.5	3.4		1,500	14.4	22	4160442K	4160444K
2.5	4.0	100		24.0	37		4160544
2.5	4.0		900	24.0	37	4160542K	4160544K
4	4.6	100		38.4	45		4160644
4	4.6		600	38.4	45	4160642K	4160644K
6	5.1	100		57.6	71		4160744
6	5.1		400	57.6	71	4160742K	4160744K
10	6.8	100		96.0	120		4160844
16	9.0	100		153.6	187		4160944

Conductor cross-section (mm <sup>2</sup> )	Outer diameter (mm)	m/box	Copper index (kg/km)	Weight (kg/km)	white-red
0.5	2.7	3,000	4.8	10	4160146K
0.75	2.9	2,500	7.2	13	4160246K
1	3.1	2,000	9.6	16	4160346K
1.5	3.4	1,500	14.4	22	4160446K
2.5	4.0	900	24.0	37	4160546K
4	4.6	600	38.4	45	4160646K
6	5.1	400	57.6	71	4160746K

Unless specified otherwise, the shown product values are nominal values. Detailed values (e.g. tolerances) are available upon request.

Copper price basis: EUR 150/100kg. Refer to Appendix T17 for the definition and calculation of copper-related surcharges.

Packaging size: Coil ≤ 30 kg, otherwise drum

Photographs are not to scale and do not represent detailed images of the respective products.

Non-harmonised, nominal cross-sections: 0.5 mm<sup>2</sup>, 0.75 mm<sup>2</sup>, 1 mm<sup>2</sup>, 16 mm<sup>2</sup>

\*for conventional use, \*\*for careful bending; "OD" = outer diameter

■ Similar products

- H07V-K refer to page 57
- Multi-Standard SC 2.2 refer to main catalogue 2012 page 206

■ Accessories

- DIN-assorted boxes conductor end sleeves refer to main catalogue 2012 page 913
- Conductor end sleeves XL, insulated refer to main catalogue 2012 page 914
- PEW 8.87 crimping pliers refer to main catalogue 2012 page 916

ÖLFLEX®  
 UNITRONIC®  
 ETHERLINE®  
 HITRONIC®  
 EPIC®  
 SKINTOP®  
 SILVYN®  
 FLEXIMARK®  
 ACCESSORIES

## Ground Straps / Flat Ground Straps

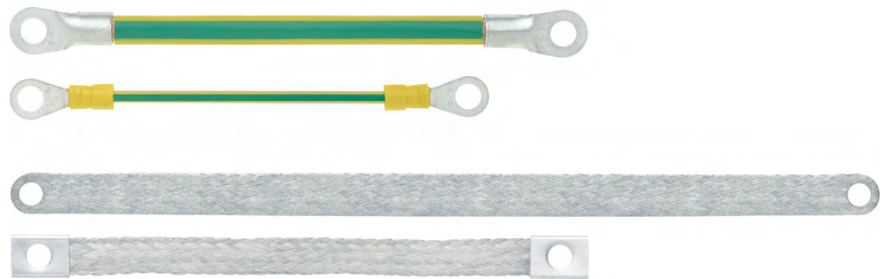

### Application range

- Control cabinet manufacturing
- The protective earth safety measure is prescribed by standard
- Fixed and moving metal parts, such as doors in switch cabinet construction, must be earthed

### Product features

- Fixed lengths for M6 and M8 screws

### Approvals



### Design

- Ground straps:
  - Strands of bare copper wires
  - PVC-based core insulation
  - Assembled with ring cable lugs
- Pressure-welded flat ground straps:
  - Strand made of tinned-copper wires
  - Welded ends
- Flat ground straps with sleeves:
  - Strands made of tinned-copper wires
  - Assembled with pressed contact sleeves

### Technical data

- Core identification code**  
Assembled ground straps  
green/yellow
- Conductor stranding**  
Assembled ground straps  
IEC 60 228 Class 6  
Assembled flat ground straps  
IEC 60 228 Class 6, tin-plated  
Extra-fine wire
- Minimum bending radius**  
Assembled ground straps  
7 x outer diameter  
Assembled flat ground straps  
5 x outer diameter
- Test voltage**  
Assembled ground straps  
2500 V
- Temperature range**  
Assembled ground straps  
-30°C to +70°C  
Assembled flat ground straps  
-5°C to +70°C

Article number	Cross-section (mm <sup>2</sup> )	Article designation	For	Length (mm)	Copper index kg/1.000 pieces	PU
<b>Ground straps</b>						
4571120	4	Ground strap 1 x 4 / M6 / 170 mm	M6	170	6.5	25
4571121	16	SZ 2565.000/EB	M6	170	26.2	25
4571122	25	SZ 2566.000/EB	M6	170	40.8	25
4571123	4	SZ 2567.000/EB	M8	300	11.4	25
4571124	16	SZ 2568.000/EB	M8	300	46.2	25
4571125	25	SZ 2569.000/EB	M8	300	72.0	25
<b>Pressure-welded flat ground straps</b>						
4571132	10	SZ 2412.210/FEP	M6	200	18.0	25
4571133	16	SZ 2412.216/FEP	M8	200	29.0	25
4571134	25	SZ 2412.225/FEP	M8	200	45.0	25
4571135	10	SZ 2412.310/FEP	M6	300	27.0	25
4571136	16	SZ 2412.316/FEP	M8	300	43.5	25
4571137	25	SZ 2412.325/FEP	M8	300	67.5	25
<b>Flat ground straps with sleeves</b>						
4571126	10	SZ 2412.210/FEH	M6	200	18.0	25
4571127	16	SZ 2412.216/FEH	M8	200	29.0	25
4571128	25	SZ 2412.225/FEH	M8	200	45.0	25
4571129	10	SZ 2412.310/FEH	M6	300	27.0	25
4571130	16	SZ 2412.316/FEH	M8	300	43.5	25
4571131	25	SZ 2412.325/FEH	M8	300	67.5	25

Unless specified otherwise, the shown product values are nominal values. Detailed values (e.g. tolerances) are available upon request.

Copper price basis: EUR 150/100kg. Refer to Appendix T17 for the definition and calculation of copper-related surcharges.

Details of the clamping force are available upon request, halogen-free.

Photographs are not to scale and do not represent detailed images of the respective products.



# UNITRONIC® LIYCY

Screened data transmission cable with colour code acc. to DIN 47100

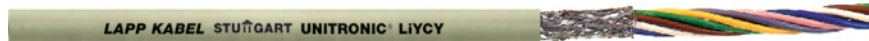

### Benefits

- Overall braid minimises electrical interference
- Multifunctional application possibilities

### Application range

- Screened cables with small dimensions are suitable for use in computer systems, instrumentation technology, balances.
- Dry or damp environment
- Nacelles & Pitch
- Control cabinet

### Product features

- Colour-coded in accordance with DIN 47100
- Flame-retardant according to IEC 60332-1-2

### Approvals



### Design

- Fine-wire/multi-wire (0.34 mm<sup>2</sup>) strand made of bare copper wires
- Core insulation made of PVC
- Tinned-copper braiding
- Outer sheath made of PVC  
Outer sheath colour: pebble grey (RAL 7032)

### Technical data

- Core identification code**  
DIN 47100 without colour repetition, refer to Appendix T9
- Mutual capacitance**  
C/C approx. 120 nF/km  
C/S: approx. 160 nF/km
- Peak operating voltage**  
(not for power applications)  
at 0.14 mm<sup>2</sup>: 350 V  
at ≥ 0.25 mm<sup>2</sup>: 500 V
- Based on**  
VDE 0812
- Specific insulation resistance**  
> 20 GOhm x cm
- Inductivity**  
approx. 0.65 mH/km
- Conductor stranding**  
Stranded, fine-wire  
0.34 mm<sup>2</sup>, 7-wire
- Minimum bending radius**  
For flexible use: 15 x outer diameter  
Fixed installation: 6 x outer diameter
- Test voltage**  
At 0.14 mm<sup>2</sup>: 1200 V  
> 0.14 mm<sup>2</sup>: 1500 V
- Temperature range**  
Occasional flexing: -5°C to +70°C  
Fixed installation: -40°C to +80°C

Article number	Number of cores and mm <sup>2</sup> per conductor	Outer diameter (mm)	Copper index (kg/km)	Weight (kg/km)
<b>UNITRONIC® LIYCY</b>				
0034302	2 x 0.14	3.9	12.0	20
0034303	3 x 0.14	4.1	13.0	28
0034304	4 x 0.14	4.3	14.3	33
0034305	5 x 0.14	4.6	15.5	38
0034306	6 x 0.14	4.9	18.2	38
0034307	7 x 0.14	4.9	19.0	49
0034308	8 x 0.14	5.8	21.2	56
0034310	10 x 0.14	6.1	28.5	66
0034312	12 x 0.14	6.3	30.4	78
0034314	14 x 0.14	6.7	32.0	80
0034315	15 x 0.14	6.9	37.8	86
0034316	16 x 0.14	7.0	43.0	90
0034318	18 x 0.14	7.3	48.8	104
0034320	20 x 0.14	7.7	53.9	116
0034321	21 x 0.14	7.9	55.5	121
0034325	25 x 0.14	8.4	63.0	149
0034328	28 x 0.14	8.5	66.1	153
0034330	30 x 0.14	8.7	69.0	158
0034332	32 x 0.14	9.0	73.6	164
0034336	36 x 0.14	9.3	83.0	183
0034340	40 x 0.14	10.4	87.5	210
0034344	44 x 0.14	10.7	110.5	225
0034350	50 x 0.14	11.1	122.5	253
0034402	2 x 0.25	4.5	16.0	32
0034403	3 x 0.25	4.7	21.0	37
0034404	4 x 0.25	5.0	24.0	41.3
0034405	5 x 0.25	5.6	29.0	51.2
0034406	6 x 0.25	6.0	30.0	58
0034407	7 x 0.25	6.0	37.0	65
0034408	8 x 0.25	7.1	42.0	73
0034410	10 x 0.25	7.5	46.0	82
0034412	12 x 0.25	7.7	53.0	98
0034414	14 x 0.25	8.0	59.0	99
0034415	15 x 0.25	8.3	61.0	111
0034416	16 x 0.25	8.4	64.0	124
0034418	18 x 0.25	8.8	83.0	143
0034420	20 x 0.25	9.3	88.0	152.3
0034421	21 x 0.25	9.6	93.0	161
0034425	25 x 0.25	10.7	114.0	172
0034428	28 x 0.25	10.8	126.0	181.1
0034430	30 x 0.25	11.0	132.0	189
0034432	32 x 0.25	11.4	138.0	203
0034436	36 x 0.25	11.8	148.0	220
0034440	40 x 0.25	12.7	157.0	248

Article number	Number of cores and mm <sup>2</sup> per conductor	Outer diameter (mm)	Copper index (kg/km)	Weight (kg/km)
0034450	50 x 0.25	13.8	178.0	318
0034461	61 x 0.25	15.0	205.0	365.2
0034502	2 x 0.34	4.9	21.0	37
0034503	3 x 0.34	5.1	27.0	49
0034504	4 x 0.34	5.7	28.0	59
0034505	5 x 0.34	6.2	30.0	66
0034506	6 x 0.34	6.8	45.0	79
0034507	7 x 0.34	6.8	48.0	83
0034508	8 x 0.34	7.8	52.0	94
0034510	10 x 0.34	8.3	74.0	129.2
0034512	12 x 0.34	8.5	80.0	142
0034514	14 x 0.34	8.9	86.0	154
0034515	15 x 0.34	9.2	90.0	155
0034516	16 x 0.34	9.4	94.0	160
0034518	18 x 0.34	10.2	103.0	173
0034520	20 x 0.34	10.7	112.0	192
0034521	21 x 0.34	11.1	116.0	199.2
0034525	25 x 0.34	11.9	135.0	259
0034528	28 x 0.34	12.0	153.0	280
0034530	30 x 0.34	12.3	159.0	291.1
0034532	32 x 0.34	13.0	165.0	305
0034536	36 x 0.34	13.4	179.0	331
0034540	40 x 0.34	14.8	200.0	365
0034550	50 x 0.34	15.9	235.0	431
0034602	2 x 0.50	5.6	29.0	54
0034603	3 x 0.50	5.9	38.0	67
0034604	4 x 0.50	6.3	43.0	77
0034605	5 x 0.50	7.0	51.0	90
0034606	6 x 0.50	7.6	59.0	104
0034607	7 x 0.50	7.6	65.0	112
0034608	8 x 0.50	8.7	70.0	135
0034610	10 x 0.50	9.3	88.0	160
0034612	12 x 0.50	9.6	99.0	177
0034618	18 x 0.50	11.8	134.0	239
0034620	20 x 0.50	12.1	149.0	276
0034625	25 x 0.50	13.7	211.0	352
0034630	30 x 0.50	14.5	230.0	397
0034702	2 x 0.75	6.0	38.0	64
0034703	3 x 0.75	6.3	49.0	76
0034704	4 x 0.75	7.0	58.0	92
0034705	5 x 0.75	7.6	67.0	109
0034707	7 x 0.75	8.2	100.0	156
0034710	10 x 0.75	10.5	130.0	187
0034712	12 x 0.75	10.8	154.0	218
0034718	18 x 0.75	13.0	195.0	327
0034725	25 x 0.75	15.3	280.0	454
0034730	30 x 0.75	15.8	312.0	486
0034802	2 x 1.00	6.3	43.0	72
0034803	3 x 1.00	6.8	56.0	90
0034804	4 x 1.00	7.3	68.0	109
0034805	5 x 1.00	8.0	79.0	126
0034807	7 x 1.00	8.6	118.0	171
0034810	10 x 1.00	11.1	140.0	228
0034812	12 x 1.00	11.4	168.0	259
0034818	18 x 1.00	13.4	252.0	389
0034825	25 x 1.00	16.2	335.0	517
0034902	2 x 1.50	7.5	58.0	90
0034903	3 x 1.50	7.9	74.0	115
0034904	4 x 1.50	8.5	108.0	153
0034905	5 x 1.50	9.3	129.0	176
0034907	7 x 1.50	10.5	164.0	220
0034912	12 x 1.50	13.7	254.0	376
0034918	18 x 1.50	16.3	350.0	519
0034925	25 x 1.50	19.9	550.0	901

Unless specified otherwise, the shown product values are nominal values. Detailed values (e.g. tolerances) are available upon request.

Copper price basis: EUR 150/100kg. Refer to Appendix T17 for the definition and calculation of copper-related surcharges.

Please find our standard lengths at: [www.lappkabel.de/en/cable-standardlengths](http://www.lappkabel.de/en/cable-standardlengths)

Packaging size: coil ≤ 30 kg or ≤ 250 m, otherwise drum

Please specify the preferred type of packaging (e.g. 1 x 500 m drum or 5 x 100 m coils).

Photographs are not to scale and do not represent detailed images of the respective products.

**Similar products**

- UNITRONIC® LiYCY (TP) refer to page 64

**Accessories**

- SKINTOP® MS-SC refer to main catalogue 2012 page 719
- Multipurpose shears A and B refer to main catalogue 2012 page 902
- SKINTOP® MS-M BRUSH refer to page 105
- SKINTOP® BRUSH ADD-ON refer to page 106

# UNITRONIC® LiYCY (TP)

Screened data transmission cable with colour code acc. to DIN 47100 and twisted pairs

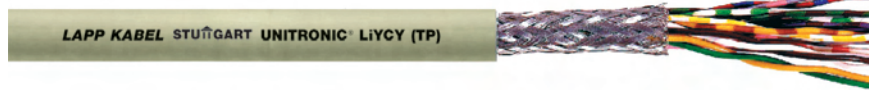

**Info**

- TP = twisted pair

**Benefits**

- Overall braid minimises electrical interference
- Twisted pair (TP) decouples the cable circuits

**Application range**

- Can be used multifunctional in electronics of computer systems, electronic control equipment etc.
- Dry or damp environment
- Nacelles & Pitch
- Control cabinet

**Product features**

- Data transmission cable with good shielding effect
- Good protection against capacitive interference from electric fields (e.g. power cable)
- Colour-coded in accordance with DIN 47100
- Flame-retardant according to IEC 60332-1-2

**Approvals**



**Design**

- Fine-wire strand made of bare copper wires
  - Core insulation made of PVC
  - TP structure
  - Tinned-copper braiding
  - Outer sheath made of PVC
- Outer sheath colour: pebble grey (RAL 7032)

**Technical data**

- Core identification code**  
DIN 47100, refer to Appendix T9
- Mutual capacitance**  
C/C approx. 120 nF/km  
C/S: approx. 160 nF/km
- Peak operating voltage**  
(not for power applications)  
at 0.14 mm<sup>2</sup>: 350 V  
at ≥ 0.25 mm<sup>2</sup>: 500 V
- Based on**  
VDE 0812
- Specific insulation resistance**  
> 20 GΩhm x cm
- Inductivity**  
Approx. 0.50 mH/km
- Conductor stranding**  
Fine copper wire strands
- Minimum bending radius**  
For flexible use:  
15 x outer diameter  
Fixed installation: 6 x outer diameter
- Test voltage**  
At 0.14 mm<sup>2</sup>: 1200 V  
> 0.14 mm<sup>2</sup>: 1500 V
- Temperature range**  
Occasional flexing: -5°C to +70°C  
Fixed installation: -40°C to +80°C

Article number	Number of pairs and mm <sup>2</sup> per conductor	Outer diameter (mm)	Copper index (kg/km)	Weight (kg/km)
<b>UNITRONIC® LiYCY (TP)</b>				
0035131	2 x 2 x 0.14	5.7	18.5	39
0035141	3 x 2 x 0.14	5.8	23.0	48
0035132	4 x 2 x 0.14	6.2	26.6	54
0035133	6 x 2 x 0.14	7.1	48.5	85
0035150	8 x 2 x 0.14	8.2	53.7	97
0035134	10 x 2 x 0.14	8.7	59.0	110
0035135	12 x 2 x 0.14	8.9	66.0	142
0035136	16 x 2 x 0.14	10.2	79.0	154
0035142	20 x 2 x 0.14	11.3	97.0	184
0035137	25 x 2 x 0.14	12.5	113.0	238
0035800	2 x 2 x 0.25	6.3	28.0	54
0035801	3 x 2 x 0.25	7.1	39.6	68.5
0035802	4 x 2 x 0.25	7.6	44.9	81
0035803	6 x 2 x 0.25	8.5	69.5	115
0035804	8 x 2 x 0.25	10.3	76.9	130
0035805	10 x 2 x 0.25	11.0	102.0	158
0035806	12 x 2 x 0.25	11.3	120.0	190
0035807	16 x 2 x 0.25	12.5	146.5	238
0035808	25 x 2 x 0.25	16.1	205.0	344
0035810	2 x 2 x 0.5	8.6	48.1	93
0035811	3 x 2 x 0.5	8.7	73.7	129
0035812	4 x 2 x 0.5	9.4	82.0	146
0035813	6 x 2 x 0.5	11.1	110.0	198
0035814	8 x 2 x 0.5	13.1	139.0	259
0035816	12 x 2 x 0.5	14.9	198.3	354
0035817	16 x 2 x 0.5	16.5	240.0	459
0035820	2 x 2 x 0.75	8.5	58.0	106
0035821	3 x 2 x 0.75	9.4	84.0	140
0035822	4 x 2 x 0.75	10.7	108.0	179
0035827	5 x 2 x 0.75	11.1	126.0	215
0035823	6 x 2 x 0.75	12.1	146.0	246
0035824	8 x 2 x 0.75	14.7	180.0	305
0035825	12 x 2 x 0.75	16.2	261.0	456
0035830	2 x 2 x 1	9.0	84.0	142
0035831	3 x 2 x 1	10.4	96.0	173
0035832	4 x 2 x 1	11.3	121.0	212
0035836	5 x 2 x 1	11.8	161.0	266

Unless specified otherwise, the shown product values are nominal values. Detailed values (e.g. tolerances) are available upon request.  
 Copper price basis: EUR 150/100kg. Refer to Appendix T17 for the definition and calculation of copper-related surcharges.  
 Please find our standard lengths at: [www.lappkabel.de/en/cable-standardlengths](http://www.lappkabel.de/en/cable-standardlengths)  
 Packaging size: coil ≤ 30 kg or ≤ 250 m, otherwise drum  
 Please specify the preferred type of packaging (e.g. 1 x 500 m drum or 5 x 100 m coils).  
 Photographs are not to scale and do not represent detailed images of the respective products.

**Similar products**

- UNITRONIC® Li2YCY (TP) fine-wired refer to page 69
- UNITRONIC® CY PIDY (TP) refer to main catalogue 2012 page 283

**Accessories**

- SKINTOP® MS-SC-M refer to page 104
- Multipurpose shears A and B refer to main catalogue 2012 page 902
- STAR STRIP stripping tool refer to main catalogue 2012 page 906
- SKINTOP® MS-M BRUSH refer to page 105
- SKINTOP® BRUSH ADD-ON refer to page 106

**UNITRONIC® PUR CP (TP)**

Screened data transmission cable with PUR outer sheath and twisted pairs for harsh conditions

**Info**

- TP = twisted pair

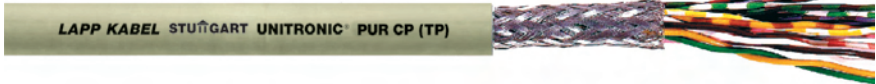

**Benefits**

- Data transmission cable with PUR sheath for increased mechanical stress, wear- and tear-resistant
- Overall braid minimises electrical interference
- Twisted pair (TP) decouples the cable circuits
- Increased durability under harsh conditions thanks to robust PUR outer sheath

**Application range**

- For harsh environmental conditions where robust and screened cables with small dimensions are necessary
- Nacelles
- Pitch system
- Top Box

**Product features**

- Low-adhesive surface
- PUR outer sheath is resistant to most oils and hydraulic fluids
- Special notch and tear-resistance
- Colour-coded in accordance with DIN 47100
- Flame-retardant according to IEC 60332-1-2

**Approvals**



**Design**

- Fine-wire strand made of bare copper wires
- Core insulation made of PVC
- TP structure
- Tinned-copper braiding
- Outer sheath made of PUR  
Outer sheath colour: pebble grey (RAL 7032)

**Technical data**

- Core identification code**  
DIN 47100, refer to Appendix T9
- Mutual capacitance**  
C/C approx. 120 nF/km  
C/S: approx. 160 nF/km
- Peak operating voltage**  
(not for power applications) 250 V
- Based on**  
VDE 0814: (DIN 47414)  
or VDE 0812
- Specific insulation resistance**  
> 20 GOhm x cm
- Inductivity**  
approx. 0.65 mH/km
- Conductor stranding**  
Fine copper wire strands
- Minimum bending radius**  
For flexible use:  
15 x outer diameter  
Fixed installation: 6 x outer diameter
- Test voltage**  
At 0.14 mm²: 1200 V  
> 0.14 mm²: 1500 V
- Temperature range**  
Occasional flexing: -5°C to +70°C  
Fixed installation: -30 °C to +80 °C

Article number	Number of pairs and conductor cross section (mm²)	Outer diameter (mm)	Copper index (kg/km)	Weight (kg/km)
<b>UNITRONIC® PUR CP (TP)</b>				
0032850	2 x 2 x 0.25	6.3	28.0	54
0032851	3 x 2 x 0.25	7.1	40.0	66
0032852	4 x 2 x 0.25	7.6	45.0	81
0032854	6 x 2 x 0.25	8.5	70.0	115
0032860	2 x 2 x 0.5	8.6	48.0	93
0032861	3 x 2 x 0.5	8.7	74.0	129
0032862	4 x 2 x 0.5	9.4	82.0	146
0032864	6 x 2 x 0.5	11.1	110.0	198
0032872	4 x 2 x 0.75	10.7	108.0	179
0032873	5 x 2 x 0.75	11.1	126.0	215

Unless specified otherwise, the shown product values are nominal values. Detailed values (e.g. tolerances) are available upon request.  
 Copper price basis: EUR 150/100kg. Refer to Appendix T17 for the definition and calculation of copper-related surcharges.  
 Please find our standard lengths at: [www.lappkabel.de/en/cable-standardlengths](http://www.lappkabel.de/en/cable-standardlengths)  
 Packaging size: coil ≤ 30 kg or ≤ 250 m, otherwise drum  
 Please specify the preferred type of packaging (e.g. 1 x 500 m drum or 5 x 100 m coils).  
 Photographs are not to scale and do not represent detailed images of the respective products.

**Accessories**

- SKINTOP® MS-SC-M refer to page 104
- SMARTSTRIP stripping tool refer to main catalogue 2012 page 906
- SKINTOP® MS-M BRUSH refer to page 105
- SKINTOP® BRUSH ADD-ON refer to page 106

# UNITRONIC® 300 / UNITRONIC® 300 CY

## Control and signal cables with small cross sections - UL/CSA listed

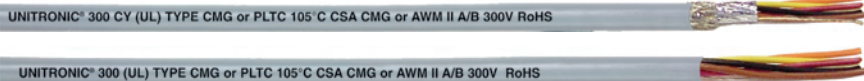

**Info**

- Unscreened + screened control and signal cables for industrial applications
- PLTC = Power Limited Tray Cable

**Benefits**

- Several approvals, such as UL Type PLTC, UL CMG, UL Oil Res I, CSA CMG and CE.
- For the North American market

**Application range**

- Control and signal cables for internal and external wiring
- UL Subject 6141
- Nacelles
- Pitch system
- Top Box
- Slip ring

**Product features**

- UV-resistant and oil-resistant cable (OIL RES I)
- AWG24 has no PLTC approval
- Exposed run for AWG18 & AWG16
- PLTC for trays ("Exposed Run"/Open Wiring) Allows cabling without cable duct.

**Approvals**



**Design**

- Fine-wire strand made of tinned-copper wires
- Core insulation made of PVC compound
- UNITRONIC® 300 CY with overall foil tape wrapping, drain wire, tin-plated copper braiding (75 % coverage)
- Oil-resistant, grey PVC outer sheath

**Technical data**

**Core identification code**  
refer to Appendix T9

**Approvals**  
UL CMG, PLTC, Open Wiring, AWM 2464, Oil Res I  
CSA CMG/FT4, CSA AWM II A/B, NOM SCFI 1994

**Minimum bending radius**  
During installation: 4 x cable diameter  
Screened: 6 x outer diameter

**Nominal voltage**  
according to UL: 300 V  
IEC: not for power transmission

**Test voltage**  
2000V

**Temperature range**  
-25°C to +105°C

Article number	Article designation	Number of cores and AWG size	Outer diameter (mm)	Copper index (kg/km)	Weight (kg/km)
<b>UNITRONIC® 300</b>					
301602	UNITRONIC® 300	2 x AWG16	6.7	25.0	83
301802	UNITRONIC® 300	2 x AWG18	6.1	18.3	61
302006	UNITRONIC® 300	6 x AWG20	7.5	29.5	97
302204	UNITRONIC® 300	4 x AWG22	5.0	13.7	33
302210	UNITRONIC® 300	10 x AWG22	7.0	34.2	67
302220	UNITRONIC® 300	20 x AWG22	9.0	68.5	116
302225	UNITRONIC® 300	25 x AWG22	10.5	85.6	142
<b>UNITRONIC® 300 CY</b>					
301602S	UNITRONIC® 300 CY	2 x AWG16	7.6	50.6	101
301606S	UNITRONIC® 300 CY	6 x AWG16	9.9	105.7	210
301802S	UNITRONIC® 300 CY	2 x AWG18	6.8	37.2	75
301803S	UNITRONIC® 300 CY	3 x AWG18	7.3	49.1	85
301804S	UNITRONIC® 300 CY	4 x AWG18	7.9	59.6	104
301825S	UNITRONIC® 300 CY	25 x AWG18	16.8	278.4	448
302002S	UNITRONIC® 300 CY	2 x AWG20	6.3	28.3	60
302004S	UNITRONIC® 300 CY	4 x AWG20	7.3	40.2	88
302006S	UNITRONIC® 300 CY	6 x AWG20	8.4	55.1	119
302206S	UNITRONIC® 300 CY	6 x AWG22	6.4	35.7	68

Unless specified otherwise, the shown product values are nominal values. Detailed values (e.g. tolerances) are available upon request.

Copper price basis: EUR 150/100kg. Refer to Appendix T17 for the definition and calculation of copper-related surcharges.

Please find our standard lengths at: [www.lappkabel.de/en/cable-standardlengths](http://www.lappkabel.de/en/cable-standardlengths)

Packaging size: Coil 152 m; Drum 305 m

Photographs are not to scale and do not represent detailed images of the respective products.

**Similar products**

- ÖLFLEX® TRAY II refer to page 32
- ÖLFLEX® TRAY II CY refer to page 33

**Accessories**

- Universal strip stripping and cutting tool refer to main catalogue 2012 page 906
- STAR STRIP stripping tool refer to main catalogue 2012 page 906
- SKINTOP® MS-M BRUSH refer to page 105
- SKINTOP® BRUSH ADD-ON refer to page 106

**UNITRONIC® FD CP plus**

Screened highly flexible data transmission cable with PUR outer sheath - UL/CSA-listed



**Info**

- Flexible at low temperatures
- Low capacitance
- Halogen-free
- Torsion-tested for wind turbines

**Benefits**

- Wide temperature range for applications in harsh climatic environments
- High mechanical strength
- Approval: UL/CSA type CMX in accordance with UL 444 and CSA C22.2 no. 214-02
- Optimized cable construction for power chain use
- Overall braid minimises electrical interference

**Application range**

- Highly flexible data transmission cable complies with the most stringent service life requirements, even in harsh climatic conditions, UL/CSA-approved
- Ideal for export-oriented machinery and equipment manufacturers
- For the North American market
- Slip ring
- Pitch system
- Top bottom Box
- Tower cable

LAPP KABEL STUTTGART UNITRONIC® FD CP plus



**Product features**

- The cable is halogen-free and has low capacitance
- PUR outer sheath, tear and notch-resistant, resistant to mineral oils and abrasion when used in power chains
- Adhesion-free, resistant to hydrolysis and microbes
- Flexible down to -40°C
- Flame-retardant according to IEC 60332-1-2 and VW-1 acc. to UL-1581

**Approvals**



**Design**

- Extra-fine wire strand made of bare copper wires
- Core insulation: Based on Polyolefin
- Tinned-copper braiding
- Outer sheath made of special PUR compound  
Outer sheath colour: grey (RAL 7001)

**Technical data**

- Core identification code**  
DIN 47100, refer to Appendix T9
- Approvals**  
CMX (UL/CSA)
- Mutual capacitance**  
C/C approx. 60 nF/km
- Peak operating voltage**  
(not for power applications) 250 V
- Specific insulation resistance**  
> 5 GOhm x km
- Inductivity**  
approx. 0.65 mH/km
- Conductor stranding**  
Stranded, extra-fine wire in accordance with VDE 0295, single wire diameter 0.1 mm
- Minimum bending radius**  
For flexible use: 7.5 x outer diameter
- Test voltage**  
Core/core: 1500 V rms  
Core/screen: 500 V
- Temperature range**  
Flexing: -40°C to +80°C  
Fixed installation: -40°C to +80°C

Article number	Number of cores and mm² per conductor	AWG size	Outer diameter (mm)	Copper index (kg/km)	Weight (kg/km)
<b>UNITRONIC® FD CP plus</b>					
0028880	2 x 0.14	26 AWG	4.5	11.2	33
0028881	3 x 0.14	26 AWG	4.7	14.1	36
0028882	4 x 0.14	26 AWG	5.1	15.5	40
0028883	5 x 0.14	26 AWG	5.4	18.3	45
0028884	7 x 0.14	26 AWG	6.0	27.8	67
0028885	10 x 0.14	26 AWG	7.0	39.3	87
0028886	14 x 0.14	26 AWG	7.1	45.3	102
0028887	18 x 0.14	26 AWG	7.7	54.1	118
0028888	25 x 0.14	26 AWG	9.2	68.4	157
0028889	2 x 0.25	24 AWG	5.1	14.9	38
0028890	3 x 0.25	24 AWG	5.4	18.8	45
0028891	4 x 0.25	24 AWG	5.8	21.3	52
0028892	5 x 0.25	24 AWG	6.2	31.0	69
0028893	7 x 0.25	24 AWG	7.0	39.6	84
0028894	10 x 0.25	24 AWG	8.5	53.9	109
0028895	14 x 0.25	24 AWG	8.6	64.2	136
0028896	18 x 0.25	24 AWG	9.4	78.4	161
0028897	25 x 0.25	24 AWG	11.4	101.0	213
0028898	2 x 0.34	22 AWG	5.6	18.1	45
0028899	3 x 0.34	22 AWG	5.9	28.7	61
0028900	4 x 0.34	22 AWG	6.3	35.7	77
0028901	5 x 0.34	22 AWG	6.8	39.1	83
0028902	7 x 0.34	22 AWG	7.7	52.7	109
0028903	10 x 0.34	22 AWG	9.4	67.4	147
0028904	14 x 0.34	22 AWG	9.5	85.8	186
0028905	18 x 0.34	22 AWG	10.7	99.7	216
0028906	25 x 0.34	22 AWG	12.9	155.0	314

Unless specified otherwise, the shown product values are nominal values. Detailed values (e.g. tolerances) are available upon request.  
 Copper price basis: EUR 150/100kg. Refer to Appendix T17 for the definition and calculation of copper-related surcharges.  
 Please find our standard lengths at: [www.lappkabel.de/en/cable-standardlengths](http://www.lappkabel.de/en/cable-standardlengths)  
 Packaging size: coil ≤ 30 kg or ≤ 250 m, otherwise drum  
 Please specify the preferred type of packaging (e.g. 1 x 500 m drum or 5 x 100 m coils).  
 Photographs are not to scale and do not represent detailed images of the respective products.

**Similar products**

- UNITRONIC® FD CP (TP) plus refer to page 68

**Accessories**

- SKINTOP® MS-SC-M refer to page 104
- SILVYN® CHAIN refer to main catalogue 2012 from page 843
- STAR STRIP stripping tool refer to main catalogue 2012 page 906
- SKINTOP® MS-M BRUSH refer to page 105
- SKINTOP® BRUSH ADD-ON refer to page 106

# UNITRONIC® FD CP (TP) plus

Screened highly flexible data transmission cable with PUR outer sheath and twisted pairs - UL/CSA-listed



**Info**

- Flexible at low temperatures
- Low capacitance
- Halogen-free
- Torsion-tested for wind turbines

**Benefits**

- Wide temperature range for applications in harsh climatic environments
- High mechanical strength
- Approval: UL/CSA type CMX in accordance with UL 444 and CSA C22.2 no. 214-02
- Overall braid minimises electrical interference
- Twisted pair (TP) decouples the cable circuits

**Application range**

- Ideal for export-oriented machinery and equipment manufacturers
- For the North American market
- Slip ring
- Nacelle
- Pitch system
- Top/bottom Box
- Tower cable

**Product features**

- The cable is halogen-free and has low capacitance
- PUR outer sheath, tear and notch-resistant, resistant to mineral oils and abrasion when used in power chains
- Adhesion-free, resistant to hydrolysis and microbes
- Flexible down to -40°C
- Flame-retardant according to IEC 60332-1-2 and VW-1 acc. to UL-1581

**Approvals**



**Design**

- Extra-fine wire strand made of bare copper wires
- Core insulation: Based on Polyolefin
- TP structure
- Tinned-copper braiding
- Outer sheath made of special PUR compound  
Outer sheath colour: grey (RAL 7001)

**Technical data**

**Core identification code**  
DIN 47100, refer to Appendix T9

**Approvals**  
CMX (UL/CSA)

**Mutual capacitance**  
Up to 0.5 mm<sup>2</sup>: 60 nF/km  
Up to 1.0 mm<sup>2</sup>: 70 nF/km

**Peak operating voltage**  
(not for power applications) 250 V

**Specific insulation resistance**  
> 5 GOhm x km

**Inductivity**  
approx. 0.65 mH/km

**Conductor stranding**  
Stranded, extra-fine wire, Class 6, in accordance with VDE 0295

**Minimum bending radius**  
7.5 x outer diameter

**Test voltage**  
Core/core: 1500 V rms  
Core/screen: 500 V

**Temperature range**  
Flexing: -40°C to +80°C  
Fixed installation: -40°C to +80°C

Article number	Number of pairs and mm <sup>2</sup> per conductor	AWG size	Outer diameter (mm)	Copper index (kg/km)	Weight (kg/km)
<b>UNITRONIC® FD CP (TP) plus</b>					
0030910	2 x 2 x 0.14	26 AWG	6.2	19.4	42
0030911	3 x 2 x 0.14	26 AWG	6.5	23.4	53
0030912	4 x 2 x 0.14	26 AWG	7.0	27.1	59
0030913	5 x 2 x 0.14	26 AWG	7.6	37.4	75
0030914	6 x 2 x 0.14	26 AWG	7.8	49.4	91
0030915	8 x 2 x 0.14	26 AWG	9.1	54.8	109
0030916	10 x 2 x 0.14	26 AWG	10.5	60.1	120
0030962	1 x 2 x 0.25	24 AWG	5.1	14.0	27
0030919	2 x 2 x 0.25	24 AWG	7.3	32.0	60
0030920	3 x 2 x 0.25	24 AWG	7.7	38.4	72
0030921	4 x 2 x 0.25	24 AWG	8.6	43.2	85
0030922	5 x 2 x 0.25	24 AWG	9.3	51.5	103
0030923	6 x 2 x 0.25	24 AWG	9.6	71.8	131
0030924	8 x 2 x 0.25	24 AWG	11.3	74.4	155
0030925	10 x 2 x 0.25	24 AWG	13.0	90.0	186
0030926	14 x 2 x 0.25	24 AWG	13.2	111.2	219
0030963	1 x 2 x 0.34	22 AWG	5.6	20.0	36
0030928	2 x 2 x 0.34	22 AWG	8.2	41.0	81
0030929	3 x 2 x 0.34	22 AWG	8.7	52.0	101
0030930	4 x 2 x 0.34	22 AWG	9.5	59.0	119
0030932	6 x 2 x 0.34	22 AWG	11.0	86.2	165
0030933	8 x 2 x 0.34	22 AWG	12.8	107.3	221
0030934	10 x 2 x 0.34	22 AWG	14.9	131.1	274
0030964	1 x 2 x 0.5	20 AWG	6.2	22.0	47
0030937	2 x 2 x 0.5	20 AWG	9.3	50.0	99
0030938	3 x 2 x 0.5	20 AWG	10.1	71.8	130
0030939	4 x 2 x 0.5	20 AWG	11.1	74.4	148
0030940	5 x 2 x 0.5	20 AWG	12.3	84.5	168
0030941	6 x 2 x 0.5	20 AWG	12.7	99.6	194
0030942	8 x 2 x 0.5	20 AWG	15.1	144.3	284
0030943	10 x 2 x 0.5	20 AWG	17.2	176.0	343
0030944	14 x 2 x 0.5	20 AWG	17.5	215.4	401
0030965	1 x 2 x 0.75	19 AWG	6.6	34.0	61
0030946	2 x 2 x 0.75	19 AWG	10.2	60.0	112
0030947	3 x 2 x 0.75	19 AWG	10.9	85.7	157
0030948	4 x 2 x 0.75	19 AWG	12.2	93.6	172
0030950	6 x 2 x 0.75	19 AWG	14.2	130.4	231
0030951	8 x 2 x 0.75	19 AWG	16.4	192.2	342
0030952	10 x 2 x 0.75	19 AWG	19.3	258.0	466
0030953	14 x 2 x 0.75	19 AWG	19.8	316.6	545
0030955	1 x 2 x 1	18 AWG	7.0	42.0	71
0030956	2 x 2 x 1	18 AWG	11.0	73.0	129
0030957	3 x 2 x 1	18 AWG	11.9	93.6	169
0030958	4 x 2 x 1	18 AWG	13.1	117.8	204
0030959	5 x 2 x 1	18 AWG	14.7	139.0	237

Unless specified otherwise, the shown product values are nominal values. Detailed values (e.g. tolerances) are available upon request.  
 Copper price basis: EUR 150/100kg. Refer to Appendix T17 for the definition and calculation of copper-related surcharges.  
 Please find our standard lengths at: [www.lappkabel.de/en/cable-standardlengths](http://www.lappkabel.de/en/cable-standardlengths)  
 Packaging size: coil ≤ 30 kg or ≤ 250 m, otherwise drum  
 Please specify the preferred type of packaging (e.g. 1 x 500 m drum or 5 x 100 m coils).  
 Photographs are not to scale and do not represent detailed images of the respective products.

**Accessories**

- SKINTOP® MS-M BRUSH refer to page 105
- SKINTOP® BRUSH ADD-ON refer to page 106

ÖLFLEX®  
 UNITRONIC®  
 ETHERLINE®  
 HITRONIC®  
 EPIC®  
 SKINTOP®  
 SILVYN®  
 FLEXIMARK®  
 ACCESSORIES

## UNITRONIC® Li2YCY (TP)

Screened data transmission cable mit PE core insulation, 7-wire strands and twisted pairs

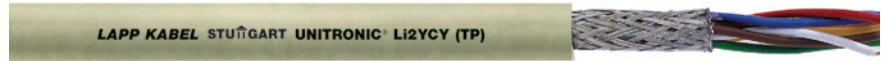

## UNITRONIC® Li2YCY (TP) fine-wired

Screened data transmission cable mit PE core insulation, fine wire strands and twisted pairs

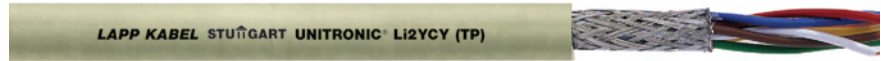

## UNITRONIC® Li2YCYv (TP)

Screened data transmission cable mit PE core insulation, reinforced outer sheath and twisted pairs



### Benefits

- 7-wire stranded conductor (UNITRONIC® Li2YCY (TP) and UNITRONIC® Li2YCYv (TP) can be used for Maxi TERMI-POINT® wiring
- Overall braid minimises electrical interference
- TP structure minimises crosstalk

### Application range

- The UNITRONIC® Li2YCYv (TP) model with reinforced black outer sheath (Yv) is suitable for indoors and outdoors, as well as direct burial in the ground.
- UNITRONIC® Li2YCY (TP) is particularly suitable for wiring data systems with transmission rates up to 10 Megabits per second, and is qualified for the RS422 and RS485 interfaces.
- Cables of this type are intended for limited flexible use, and for fixed installation in dry or damp environments
- Slip ring
- Nacelle
- Pitch system
- Top Box

### Product features

- Flame-retardant according to IEC 60332-1-2

### Approvals



### Design

#### UNITRONIC® Li2YCY (TP)

- 7-wire tinned stranded copper conductor
- Core insulation made of polyethylene (PE)
- TP structure
- Tinned-copper braiding
- Outer sheath made of PVC
- Outer sheath colour: pebble grey (RAL 7032)

#### UNITRONIC® Li2YCY (TP) fine-wired

- Similar to UNITRONIC® Li2YCY (TP), but with fine-wire conductor design

#### UNITRONIC® Li2YCYv (TP)

- Similar to UNITRONIC® Li2YCY (TP), but with reinforced PVC outer sheath (Yv)
- Outer sheath colour: black (RAL 9005)

### Technical data

 **Core identification code**  
DIN 47100, refer to Appendix T9

 **Mutual capacitance**  
**UNITRONIC® Li2YCY (TP)**  
At 800 Hz: max. 60 nF/km

 **Peak operating voltage**  
(not for power applications) 250 V

 **Based on**  
**UNITRONIC® Li2YCY (TP)**  
VDE 0812

 **Specific insulation resistance**  
> 5 GOhm x km

 **Inductivity**  
**UNITRONIC® Li2YCY (TP)**  
approx. 0.65 mH/km

 **Conductor stranding**  
**UNITRONIC® Li2YCY (TP)**  
Stranded conductor, based on VDE 0881, 7-wire  
**UNITRONIC® Li2YCY (TP) fine-wired**  
Stranded conductor, fine-wire  
**UNITRONIC® Li2YCYv (TP)**  
Stranded conductor, based on VDE 0881, 7-wire

 **Minimum bending radius**  
For flexible use:  
15 x outer diameter  
Fixed installation: 6 x outer diameter

**Short-range crosstalk attenuation**  
Up to 1 MHz min. 50 dB  
Up to 10 MHz min. 40 dB

 **Test voltage**  
**UNITRONIC® Li2YCY (TP)**  
Core/core: 2000 V  
Core/screen: 1000 V

 **Temperature range**  
Occasional flexing: -5 °C to +70 °C  
Fixed installation: -30 °C to +80 °C

 **Characteristic impedance**  
100 Ohm +- 15

Article number	Number of pairs and mm² per conductor	Outer diameter (mm)	Copper index (kg/km)	Weight (kg/km)
<b>UNITRONIC® Li2YCY (TP)</b>				
0031320	2 x 2 x 0,22	6,5	24,2	59
0031321	3 x 2 x 0,22	7,1	28,6	66
0031322	4 x 2 x 0,22	7,3	34,2	78
0031323	8 x 2 x 0,22	9,1	70,0	125
0031324	10 x 2 x 0,22	10,4	76,0	143
0031335	1 x 2 x 0,34	5,8	20,0	44
0031325	2 x 2 x 0,34	7,7	34,1	79
0031326	3 x 2 x 0,34	8,9	43,0	89



Article number	Number of pairs and mm <sup>2</sup> per conductor	Outer diameter (mm)	Copper index (kg/km)	Weight (kg/km)
0031327	4 x 2 x 0,34	8.7	47.0	101
0031328	8 x 2 x 0,34	11.0	85.8	176
0031336	1 x 2 x 0,5	6.3	29.0	53
0031330	2 x 2 x 0,5	8.5	37.0	85
0031331	3 x 2 x 0,5	9.3	55.0	105
0031332	4 x 2 x 0,5	9.6	60.0	122
0031333	8 x 2 x 0,5	12.7	113.3	213
0031334	10 x 2 x 0,5	14.8	154.0	261
<b>UNITRONIC® Li2YCY (TP) fine-wire</b>				
0031370	1 x 2 x 0,25	5.7	14.0	38
0031371	2 x 2 x 0,25	6.9	28.0	56
0031372	3 x 2 x 0,25	7.5	39.6	64
0031373	5 x 2 x 0,25	8.3	50.0	93
<b>UNITRONIC® Li2YCYv (TP) black for outdoor installation and direct burial</b>				
0031350	2 x 2 x 0,22	8.1	24.2	79
0031351	3 x 2 x 0,22	8.7	28.6	93
0031352	4 x 2 x 0,22	8.8	34.2	100
0031353	8 x 2 x 0,22	10.7	70.0	156
0031354	10 x 2 x 0,22	12.0	76.0	185
0031365	1 x 2 x 0,34	7.4	20.0	69
0031355	2 x 2 x 0,34	9.3	34.1	102
0031356	3 x 2 x 0,34	10.0	43.0	117
0031357	4 x 2 x 0,34	10.3	52.8	130
0031358	8 x 2 x 0,34	12.6	85.8	206
0031366	1 x 2 x 0,5	7.9	29.0	79
0031360	2 x 2 x 0,5	10.1	37.0	120
0031361	3 x 2 x 0,5	10.9	55.0	142
0031362	4 x 2 x 0,5	11.2	60.0	160
0031363	8 x 2 x 0,5	13.9	113.3	251
0031364	10 x 2 x 0,5	16.0	148.0	303

Unless specified otherwise, the shown product values are nominal values. Detailed values (e.g. tolerances) are available upon request.

Copper price basis: EUR 150/100kg. Refer to Appendix T17 for the definition and calculation of copper-related surcharges.

Please find our standard lengths at: [www.lappkabel.de/en/cable-standardlengths](http://www.lappkabel.de/en/cable-standardlengths)

Packaging size: coil ≤ 30 kg or ≤ 250 m, otherwise drum

Please specify the preferred type of packaging (e.g. 1 x 500 m drum or 5 x 100 m coils).

TERMI-POINT® is a registered trademark of AMP

Photographs are not to scale and do not represent detailed images of the respective products.

#### ■ Accessories

- SKINTOP® MS-SC-M refer to page 104
- Multipurpose shears A and B refer to main catalogue 2012 page 902
- STAR STRIP stripping tool refer to main catalogue 2012 page 906
- STEEL GUN HT-338 cable tie pliers refer to main catalogue 2012 page 963
- LS steel cable ties refer to main catalogue 2012 page 961
- SKINTOP® MS-M BRUSH refer to page 105
- SKINTOP® BRUSH ADD-ON refer to page 106

**UNITRONIC® Li2YCY PiMF**

Screened data transmission cable with PE core insulation and pairs in metalfoil



**Benefits**

- Data transmission cable with low capacitance, pair screening and overall copper braiding
- 7-wire stranded conductor can be used for Maxi TERMI-POINT® wiring
- Individually screened pairs and the overall braid minimise electrical interference enormously
- TP structure minimises crosstalk

**Application range**

- UNITRONIC® Li2YCY PiMF with individual screening of the pairs is particularly suitable for wiring data systems and controls in large industrial plants, for the transmission of sensitive signals and high bit rates for enhanced requirements in near-end cross-talk attenuation and high electrical interference in the circuits
- For measurement value transmission and serial 2-wire interfaces
- Cables of this type are intended for limited flexible use, and for fixed installation in dry or damp interiors
- Nacelle
- Pitch system

**Product features**

- Flame-retardant according to IEC 60332-1-2

**Approvals**



**Design**

- 7-wire or fine wire (1mm<sup>2</sup>) tinned stranded copper conductor
- Core insulation made of polyethylene (PE)
- Cores twisted into pairs
- Foil wrapping, static screening made of aluminium-laminated plastic film with copper drain wire for each pair
- Bare copper screen braiding
- Outer sheath made of PVC  
Outer sheath colour: pebble grey (RAL 7032)

**Technical data**

- Core identification code**  
0.22 mm<sup>2</sup>-0.5 mm<sup>2</sup>: according to DIN 47100, see table T9  
1.0 mm<sup>2</sup>: see design data
- Mutual capacitance**  
At 800 Hz:  
0.22 mm<sup>2</sup> max. 70 nF/km  
0.34 mm<sup>2</sup> max. 70 nF/km  
0.5 mm<sup>2</sup> max. 75 nF/km  
1.0 mm<sup>2</sup> max. 85 nF/km
- Peak operating voltage**  
(not for power applications) 250 V
- Insulation resistance**  
> 5 GOhm x km
- Inductivity**  
Approx. 0.4 mH/km
- Conductor stranding**  
7- or fine-wired strand according to VDE 0881
- Minimum bending radius**  
Fixed installation: 10 x outer diameter
- Short-range crosstalk attenuation**  
Up to 1 MHz min. 80 dB
- Test voltage**  
Core/core: 2000 V  
Core/screen: 1000 V
- Temperature range**  
Occasional flexing: -5°C to +70°C  
Fixed installation: -30 °C to +80 °C
- Characteristic impedance**  
at f > 1 MHz: approx. 85 Ohm

Article number	Number of pairs and mm <sup>2</sup> per conductor	Outer diameter (mm)	Copper index (kg/km)	Weight (kg/km)
<b>UNITRONIC® Li2YCY PiMF</b>				
<b>7-wire</b>				
0034040	2 x 2 x 0.22	7.7	33.0	75.4
0034041	3 x 2 x 0.22	8.1	42.0	86
0034042	4 x 2 x 0.22	8.7	50.0	99
0034043	8 x 2 x 0.22	10.9	85.0	161.4
0034044	10 x 2 x 0.22	12.5	100.0	186.4
0034045	2 x 2 x 0.34	9.0	43.0	70
0034046	3 x 2 x 0.34	9.4	55.0	85
0034047	4 x 2 x 0.34	9.8	64.0	103
0034048	8 x 2 x 0.34	12.9	127.0	191
0034049	10 x 2 x 0.34	14.9	150.0	230
<b>7-wire</b>				
0034060	2 x 2 x 0.5	8.5	51.0	96
0034061	3 x 2 x 0.5	10.4	66.0	116
0034062	4 x 2 x 0.5	11.3	71.0	141
0034063	5 x 2 x 0.5	11.8	92.0	180
0034064	8 x 2 x 0.5	14.5	153.0	271
0034065	10 x 2 x 0.5	16.6	182.0	327
<b>Fine wire</b>				
0034070	2 x 2 x 1	9.9	82.0	126
0034071	3 x 2 x 1	11.8	109.0	156
0034072	4 x 2 x 1	12.7	133.0	193
0034073	10 x 2 x 1	19.7	326.0	492

Unless specified otherwise, the shown product values are nominal values. Detailed values (e.g. tolerances) are available upon request.  
 Copper price basis: EUR 150/100kg. Refer to Appendix T17 for the definition and calculation of copper-related surcharges.  
 Please find our standard lengths at: [www.lappkabel.de/en/cable-standardlengths](http://www.lappkabel.de/en/cable-standardlengths)  
 Packaging size: coil ≤ 30 kg or ≤ 250 m, otherwise drum  
 Please specify the preferred type of packaging (e.g. 1 x 500 m drum or 5 x 100 m coils).  
 TERMI-POINT® is a registered trademark of AMP  
 Photographs are not to scale and do not represent detailed images of the respective products.

**Accessories**

- STAR STRIP stripping tool refer to main catalogue 2012 page 906
- KS 20 cable shears refer to main catalogue 2012 page 904
- SKINTOP® MS-M BRUSH refer to page 105
- SKINTOP® BRUSH ADD-ON refer to page 106

## UNITRONIC® BUS PB FD P

Highly flexible application

LAPP KABEL STUÏGART UNITRONIC® BUS PB FD P

### Benefits

- For use where the combination of a halogen-free outer sheath with properties similar to PUR and enhanced flame-retardance is required
- For highly flexible applications (power chains, moving machine parts)
- Cables can be used for PROFIBUS-DP as well as PROFIBUS-FMS and FIP

- Based on the bit rates listed, in accordance with PNO specifications the following maximum cable lengths for a bus segment apply (cable type A, PROFIBUS-DP):  
93.75 kbit/s = 1200 m  
187.5 kbit/s = 1000 m  
500 kbit/s = 400 m  
1.5 Mbit/s = 200 m  
12.0 Mbit/s = 100 m

### Application range

- PROFIBUS® (in accordance with DIN 19245 and EN 50170, e.g. for SIEMENS SIMATIC® NET)
- Pitch - Slip ring connection
- Tower cable

### Approvals



### Design

- Foam Skin - core isolation (O2YS)
- Overall screening with copper braid and plastic-laminated aluminium foil
- Tin-plated copper wire braiding
- Outer sheath: PUR compound

### Product features

- Halogen-free and Oil-resistant
- Flame-retardant according to IEC 60332-1-2

Article number	Article designation	Number of pairs and conductor diameter (mm)	Outer diameter (mm)	Copper index (kg/km)	Weight (kg/km)
<b>For highly flexible applications (e.g. power chains) - conventional cable assembly</b>					
2170222	UNITRONIC® BUS PB FD P 1x2x0,64	1 x 2 x 0,64	8,0	30,1	64

Unless specified otherwise, the shown product values are nominal values. Detailed values (e.g. tolerances) are available upon request. Copper price basis: EUR 150/100kg. Refer to Appendix T17 for the definition and calculation of copper-related surcharges. Please find our standard lengths at: [www.lappkabel.de/en/cable-standardlengths](http://www.lappkabel.de/en/cable-standardlengths)  
Packaging size: coil ≤ 30 kg or ≤ 250 m, otherwise drum  
Please specify the preferred type of packaging (e.g. 1 x 500 m drum or 5 x 100 m coils).  
SIMATIC® is a registered trademark of SIEMENS AG. FIP is a registered trademark of World FIP  
Lapp Kabel is a member of the PROFIBUS user organisation (PNO)  
Photographs are not to scale and do not represent detailed images of the respective products.



### Info

- Torsion-tested for wind turbines

### Technical data

- Mutual capacitance** (800 Hz): max. 30 nF/km
- Peak operating voltage** (not for power applications) 250 V
- Minimum bending radius** 65mm
- Test voltage** Core/core: 1500 V rms
- Temperature range** Flexing: -30°C to +70°C  
Fixed installation: -40°C to +80°C
- Characteristic impedance** 150 ± 15 Ohm

### Suitable connectors

- EPIC® Data connectors

## UNITRONIC® BUS PB FD P A

Highly flexible application

LAPP KABEL STUÏGART UNITRONIC® BUS PB FD P A

### Benefits

- For use where the combination of a halogen-free outer sheath with properties similar to PUR and enhanced flame-retardance is required
- Cables can be used for PROFIBUS-DP as well as PROFIBUS-FMS and FIP
- For highly flexible applications (power chains, moving machine parts)

- Based on the bit rates listed, in accordance with PNO specifications the following maximum cable lengths for a bus segment apply (cable type A, PROFIBUS-DP):  
93.75 kbit/s = 1200 m  
187.5 kbit/s = 1000 m  
500 kbit/s = 400 m  
1.5 Mbit/s = 200 m  
12.0 Mbit/s = 100 m

### Application range

- PROFIBUS® (in accordance with DIN 19245 and EN 50170, e.g. for SIEMENS SIMATIC® NET)
- Pitch - Slip ring connection
- Tower cable

### Approvals



- Approval: UL/CSA type CMX in accordance with UL 444 and CSA C22.2 no. 214-02

### Design

- Stranded bare copper wire
- Foam Skin - core isolation (O2YS)
- Overall screening with copper braid and plastic-laminated aluminium foil
- Screening: wrapped with braided tinned-copper wires
- Outer sheath: PUR compound

### Product features

- Halogen-free and Oil-resistant
- Flame-retardant according to IEC 60332-1-2

Article number	Article designation	Number of pairs and conductor diameter (mm)	Outer diameter (mm)	Copper index (kg/km)	Weight (kg/km)
<b>Highly flexible application</b>					
2170822	UNITRONIC® BUS PB FD P A	1 x 2 x 0,64	8,0	30,1	58

Unless specified otherwise, the shown product values are nominal values. Detailed values (e.g. tolerances) are available upon request. Copper price basis: EUR 150/100kg. Refer to Appendix T17 for the definition and calculation of copper-related surcharges. Please find our standard lengths at: [www.lappkabel.de/en/cable-standardlengths](http://www.lappkabel.de/en/cable-standardlengths)  
Packaging size: coil ≤ 30 kg or ≤ 250 m, otherwise drum  
Please specify the preferred type of packaging (e.g. 1 x 500 m drum or 5 x 100 m coils).  
SIMATIC® is a registered trademark of SIEMENS AG. FIP is a registered trademark of World FIP  
Lapp Kabel is a member of the PROFIBUS user organisation (PNO)  
Photographs are not to scale and do not represent detailed images of the respective products.



### Info

- A for Advanced here: UL and CSA approvals

### Technical data

- Mutual capacitance** (800 Hz): max. 30 nF/km
- Peak operating voltage** (not for power applications) 250 V
- Minimum bending radius** 65mm
- Test voltage** Core/core: 1500 V rms
- Temperature range** Flexing: -30°C to +70°C  
Fixed installation: -40°C to +80°C
- Characteristic impedance** 150 ± 15 Ohm

### Suitable connectors

- EPIC® Data connectors

## UNITRONIC® DeviceNet THICK + THIN

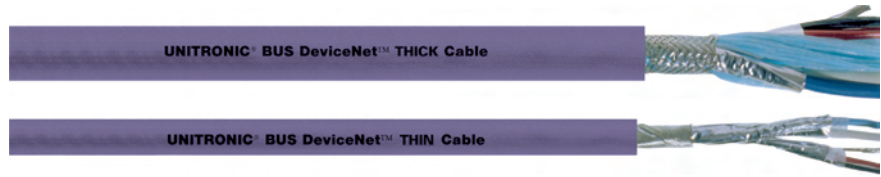

### Application range

- Fixed installation
- DeviceNet™ connects industrial devices e.g. limit switches, photoelectric switches, valve islands, motor starters, drives, PLCs, etc.
- Nacelles
- Slip ring - Pitch connection

### Product features

- Resistant to oils
- Based on proven CAN (Controller Area Network) technology.
- Permissible cable lengths vary with the data rate and the cable thickness
- Refer to data sheet for more details

### Approvals



- CMG UL/CSA approval 75°C or PLTC, Sun Res
- FRNC variant with Germanischer Lloyd approval

### Design

- A) Halogen-free (2170340 + 2170341)
- B) Polyvinylchloride (PVC) (2170342 + 2170343, 2170362 + 2170363)

### Technical data

- Core identification code**  
Data pair: light blue + white  
Power supply: red + black
- Mutual capacitance**  
(800 Hz): max. 39.8 nF/km
- Peak operating voltage**  
300 V (not for power applications)
- Conductor resistance**  
Thick (loop): max. 45 ohm/km  
Thin (loop): max. 180 ohm/km
- Minimum bending radius**  
Fixed installation: 15 x cable diameter
- Test voltage**  
Core/core: 2000 V
- Temperature range**  
Fixed installation: -25°C to +80°C
- Characteristic impedance**  
120 ohm

Article number	Article designation	Number of pairs and AWG size	Outer diameter (mm)	Copper index (kg/km)	Weight (kg/m)
<b>Halogen-free</b>					
2170340	UNITRONIC® BUS DN THICK FRNC	1x2xAWG18 + 1x2xAWG15	12.2	88.4	195
2170341	UNITRONIC® BUS DN THIN FRNC	1x2xAWG24 + 1x2xAWG22	6.9	33.4	69.5
<b>With PVC outer sheath</b>					
2170342	UNITRONIC® BUS DN THICK Y	1x2xAWG18 + 1x2xAWG15	12.2	88.4	192
2170343	UNITRONIC® BUS DN THIN Y	1x2xAWG24 + 1x2xAWG22	6.9	33.4	66.9

Unless specified otherwise, the shown product values are nominal values. Detailed values (e.g. tolerances) are available upon request.  
 Copper price basis: EUR 150/100kg. Refer to Appendix T17 for the definition and calculation of copper-related surcharges.  
 Please find our standard lengths at: [www.lappkabel.de/en/cable-standardlengths](http://www.lappkabel.de/en/cable-standardlengths)  
 FRNC means Flame-Retardant, Non-Corrosive; and DeviceNet is a registered trademark of ODVA.  
 Lapp Kabel is a member of the PROFIBUS user organisation (PNO)  
 ECO is the cost-efficient version of article no. 2170342 and 2170343, with a slight modification to the outer sheath and UL/CSA-approved (CMG).  
 Photographs are not to scale and do not represent detailed images of the respective products.

**Cables for bus system DeviceNet**

Characteristic impedance: 120 ohm

**UNITRONIC® DeviceNet FD THICK+THIN**

Highly flexible and UL/CSA-approved

LAPP KABEL STUÏGART UNITRONIC® BUS DN THICK FD P

LAPP KABEL STUÏGART UNITRONIC® BUS DN THIN FD P

**Application range**

- For highly flexible applications
- DeviceNet™ connects industrial devices e.g. limit switches, photoelectric switches, valve islands, motor starters, drives, PLCs, etc.
- Nacelle
- Slip ring – Pitch connection

**Product features**

- Based on proven CAN (Controller Area Network) technology.
- Permissible cable lengths vary with the data rate and the cable thickness
- Refer to data sheet for more details

**Approvals**



- PUR: UL/CSA-approved (CMX)
- PVC: UL/CSA CMG 75 °C or PLTC FT4 Sun Res Oil Res

**Design**

- Polyurethane (PUR) (2170344 + 2170345)
- Polyvinylchloride (PVC) (2170346 + 2170347)

**Technical data**

- Core identification code**  
Data pair: light blue + white  
Power supply: red + black
- Mutual capacitance**  
(800 Hz): max. 39.8 nF/km
- Peak operating voltage**  
300 V (not for power applications)
- Conductor resistance**  
Thick (loop): max. 45 ohm/km  
Thin (loop): max. 180 ohm/km
- Minimum bending radius**  
Fixed installation: 7.5 x cable diameter  
Flexing: 15 x outer diameter
- Test voltage**  
Core/core: 2000 V
- Temperature range**  
PUR: -40 °C to +80 °C  
PVC: -10 °C to +80 °C
- Characteristic impedance**  
120 ohm

Article number	Article designation	Number of pairs and AWG size	Outer diameter (mm)	Copper index (kg/km)	Weight (kg/m)
<b>Version P (PUR)</b>					
2170344	UNITRONIC® BUS DN THICK FD P	1x2xAWG18 + 1x2xAWG15	12.2	94.0	184
2170345	UNITRONIC® BUS DN THIN FD P	1x2xAWG24 + 1x2xAWG22	6.9	33.4	67.7
<b>Version Y (PVC)</b>					
2170346	UNITRONIC® BUS DN THICK FD Y	1x2xAWG18 + 1x2xAWG15	12.2	94.0	195
2170347	UNITRONIC® BUS DN THIN FD Y	1x2xAWG24 + 1x 2xAWG22	6.9	33.4	69.8

Unless specified otherwise, the shown product values are nominal values. Detailed values (e.g. tolerances) are available upon request.  
 Copper price basis: EUR 150/100kg. Refer to Appendix T17 for the definition and calculation of copper-related surcharges.  
 Please find our standard lengths at: [www.lappkabel.de/en/cable-standardlengths](http://www.lappkabel.de/en/cable-standardlengths)  
 DeviceNet is a registered trademark of ODVA  
 Photographs are not to scale and do not represent detailed images of the respective products.

**Accessories**

- SILVYN® CHAIN refer to main catalogue 2012 from page 843
- SMARTSTRIP stripping tool refer to main catalogue 2012 page 907

ÖLFLEX®  
UNITRONIC®  
ETHERLINE®  
HITRONIC®  
EPIC®  
SKINTOP®  
SILVYN®  
FLEXIMARK®  
ACCESSORIES

**UNITRONIC® BUS CAN**

**UNITRONIC® BUS CAN FD P**



Info

- CAN = Controller Area Network

LAPP KABEL STUÏGART UNITRONIC® BUS CAN

LAPP KABEL STUÏGART UNITRONIC® BUS CAN FD P

**Application range**

**UNITRONIC® BUS CAN**

- Fixed installation

**UNITRONIC® BUS CAN FD P**

- For highly flexible applications

**UNITRONIC® BUS CAN**

**UNITRONIC® BUS CAN FD P**

- Pitch - Slip ring connection
- Nacelle

**Product features**

**UNITRONIC® BUS CAN**

- Maximum bit rate: 1 Mbit/s for 40 m segment length
- Larger conductor cross-section is necessary with increasing length. Refer to the table below (reference values from ISO 11898).
- ISO 11898 makes recommendations for the segment length, cable cross section and bit rate
- Flame-retardant according to IEC 60332-1-2

**UNITRONIC® BUS CAN FD P**

- Halogen-free
- Maximum bit rate: 1 Mbit/s for 40 m segment length
- Larger conductor cross-section is necessary with increasing length. Refer to the table below (reference values from ISO 11898).
- ISO 11898 makes recommendations for the segment length, cable cross section and bit rate
- Flame-retardant according to IEC 60332-1-2

**Approvals**



- Standardised internationally in ISO 11898
- UL/CSA type CMX (UL 444)

**Design**

**UNITRONIC® BUS CAN**

- 0.22 + 0.34 + 0.5: bare stranded conductor, 7-wire
- 0.75: bare stranded conductor, fine-wire
- Colour-coded in accordance with DIN 47100
- Copper braiding
- PVC outer sheath
- Colour: violet (RAL 4001)

**UNITRONIC® BUS CAN FD P**

- Stranded bare conductor
- Screening: wrapped with braided copper wires
- PUR outer sheath
- Colour: violet (RAL 4001)
- UV-resistant (but colour may change after some time)

**Technical data**

**Mutual capacitance**  
**UNITRONIC® BUS CAN**  
 (800 Hz): max. 40 nF/km  
**UNITRONIC® BUS CAN FD P**  
 (800 Hz): max. 60 nF/km

**Peak operating voltage**  
**UNITRONIC® BUS CAN**  
 (not for power applications) 250 V  
**UNITRONIC® BUS CAN FD P**  
 250 V (not for power transmission)

**Conductor resistance**  
**UNITRONIC® BUS CAN**  
 (loop):  
 max. 186 ohm/km  
**UNITRONIC® BUS CAN FD P**  
 (loop): max. 159.8 ohm/km

**Minimum bending radius**  
**UNITRONIC® BUS CAN**  
 Fixed installation: 8 x outer diameter  
**UNITRONIC® BUS CAN FD P**  
 Flexing: 15 x outer diameter

**Test voltage**  
 Core/core: 1500 V rms

**Temperature range**  
**UNITRONIC® BUS CAN**  
 Flexing: -5°C to +70°C  
 Fixed installation:  
 -30°C to +80°C  
**UNITRONIC® BUS CAN FD P**  
 Flexing: -30°C to +70°C  
 Fixed installation: -40°C to +80°C

**Characteristic impedance**  
 120 ohm

Article number	Article designation	Number of pairs/conductor cross section (mm <sup>2</sup> )	Outer diameter (mm)	Copper index (kg/km)	Weight (kg/km)
<b>For fixed installation</b>					
2170260	UNITRONIC® BUS CAN	1 x 2 x 0,22	5.7	16.7	42.0
2170261	UNITRONIC® BUS CAN	2 x 2 x 0,22	7.6	34.8	68.0
2170263	UNITRONIC® BUS CAN	1 x 2 x 0,34	6.8	25.0	55.0
2170264	UNITRONIC® BUS CAN	2 x 2 x 0,34	8.5	46.4	88.0
2170266	UNITRONIC® BUS CAN	1 x 2 x 0,5	7.5	41.6	90.0
2170267	UNITRONIC® BUS CAN	2 x 2 x 0,5	9.7	59.4	106.0
2170269	UNITRONIC® BUS CAN	1 x 2 x 0,75	8.7	52.7	108.0
2170270	UNITRONIC® BUS CAN	2 x 2 x 0,75	11.5	80.6	142.0
<b>For highly flexible applications (power chains, moving machine parts)</b>					
2170272	UNITRONIC® BUS CAN FD P	1 x 2 x 0,25	6.4	24.0	40.0
2170273	UNITRONIC® BUS CAN FD P	2 x 2 x 0,25	8.4	33.0	65.0
2170275	UNITRONIC® BUS CAN FD P	1 x 2 x 0,34	6.8	32.8	60.0
2170276	UNITRONIC® BUS CAN FD P	2 x 2 x 0,34	9.6	52.4	88.0
2170278	UNITRONIC® BUS CAN FD P	1 x 2 x 0,5	8.0	41.9	74.0
2170279	UNITRONIC® BUS CAN FD P	2 x 2 x 0,5	10.8	59.4	100.0

Unless specified otherwise, the shown product values are nominal values. Detailed values (e.g. tolerances) are available upon request.

Copper price basis: EUR 150/100kg. Refer to Appendix T17 for the definition and calculation of copper-related surcharges.

Please find our standard lengths at: [www.lappkabel.de/en/cable-standardlengths](http://www.lappkabel.de/en/cable-standardlengths)

Packaging size: coil ≤ 30 kg or ≤ 250 m, otherwise drum

Please specify the preferred type of packaging (e.g. 1 x 500 m drum or 5 x 100 m coils).

Photographs are not to scale and do not represent detailed images of the respective products.

**Accessories**

- Multipurpose shears A and B refer to main catalogue 2012 page 902
- SMARTSTRIP stripping tool refer to main catalogue 2012 page 907
- SKINTOP® MS-M BRUSH refer to page 105
- SKINTOP® BRUSH ADD-ON refer to page 106

**New**

## S/A cable: shielded, M12 socket on free conductor end



S/A cable: shielded, M12 socket on free conductor end

### Benefits

- Cost-saving due to quick and easy installation
- Space-saving due to compact dimensions
- Fast and easy error tracking
- Standardised interfaces

### Application range

- Automation technology
- Mechanical engineering
- Plant engineering
- Nacelle
- Limit switch
- Temp. sensor
- Speed sensor
- Hydraulic pitch system (UL)

### Product features

- 3, 4 and 5-pin version
- Socket with M12 thread to free conductor end
- The cables have marker carriers
- Free of substances that could hinder paint or varnish
- More designs on request

### Approvals



### Design

- Fixed flexible control cable
- Design:
  - 3 x 0.34 mm<sup>2</sup> (42 x 0.1 mm)
  - 4 x 0.34 mm<sup>2</sup> (42 x 0.1 mm)
  - 5 x 0.34 mm<sup>2</sup> (42 x 0.1 mm)
- Outer sheath: PUR, halogen-free, screened
- Outer sheath colour: black

### Technical data



**Protection rating**  
IP65/IP67/IP69K



**Ambient temperature (operation)**  
Plug/socket  
-25°C to +90°C  
Cable, flexible installation  
-5°C to +80°C  
Cable, fixed installation  
-25°C to +80°C

**Contact material**  
CuSn

**Contact surface material**  
Ni/Au

**Coding**  
A - Standard

**Knurl material**  
Zinc die-cast, nickel-plated

**Gripping body material**  
TPU, flame-retardant, self-extinguishing

Article number	Article designation	Length (m)	Nominal voltage U <sub>N</sub> (V)	Nominal current I <sub>N</sub> in (A)	Status display	PU
<b>3-pin straight socket</b>						
22260450	AB-C3- 2,0PUR-M12FS-SH	2	250	4	no	1
22260451	AB-C3- 5,0PUR-M12FS-SH	5	250	4	no	1
22260452	AB-C3-10,0PUR-M12FS-SH	10	250	4	no	1
<b>3-pin angled socket</b>						
22260071	AB-C3- 2,0PUR-M12FA-SH	2	250	4	no	1
22260072	AB-C3- 5,0PUR-M12FA-SH	5	250	4	no	1
22260073	AB-C3-10,0PUR-M12FA-SH	10	250	4	no	1
<b>4-pin straight socket</b>						
22260456	AB-C4- 2,0PUR-M12FS-SH	2	250	4	no	1
22260457	AB-C4- 5,0PUR-M12FS-SH	5	250	4	no	1
22260458	AB-C4-10,0PUR-M12FS-SH	10	250	4	no	1
22260823	AB-C4-20,0PUR-M12FS-SH	20	250	4	no	1
<b>4-pin angled socket</b>						
22260074	AB-C4- 2,0PUR-M12FA-SH	2	250	4	no	1
22260675	AB-C4- 5,0PUR-M12FA-SH	5	250	4	no	1
22260680	AB-C4-10,0PUR-M12FA-SH	10	250	4	no	1
<b>5-pin straight socket</b>						
22260462	AB-C5- 2,0PUR-M12FS-SH	2	60	4	no	1
22260463	AB-C5- 5,0PUR-M12FS-SH	5	60	4	no	1
22260464	AB-C5-10,0PUR-M12FS-SH	10	60	4	no	1
<b>5-pin angled socket</b>						
22260946	AB-C5- 2,0PUR-M12FA-SH	2	60	4	no	1
22260714	AB-C5- 5,0PUR-M12FA-SH	5	60	4	no	1
22260991	AB-C5-10,0PUR-M12FA-SH	10	60	4	no	1

Unless specified otherwise, the shown product values are nominal values. Detailed values (e.g. tolerances) are available upon request.

Copper price basis: inclusive of copper. Refer to Appendix T17 for the definition and calculation of copper-related surcharges.

Customised cable lengths, outer-sheath materials (e.g. PVC), and types of connectors are available upon request.

Photographs are not to scale and do not represent detailed images of the respective products.

For detailed technical information please refer to the data sheet ([www.lappautomation.com](http://www.lappautomation.com))

UL approvals can be found in the data sheet ([www.lappautomation.com](http://www.lappautomation.com))

For the UNITRONIC® field bus type code, please see table T6

S/A cable: 3-pos., valve connector on free conductor end

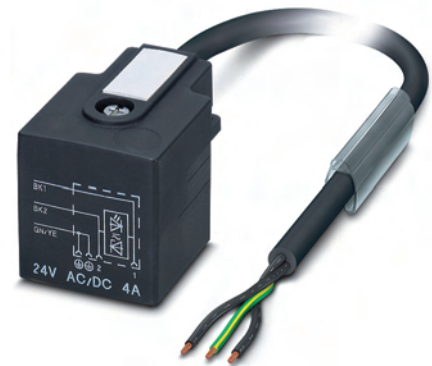
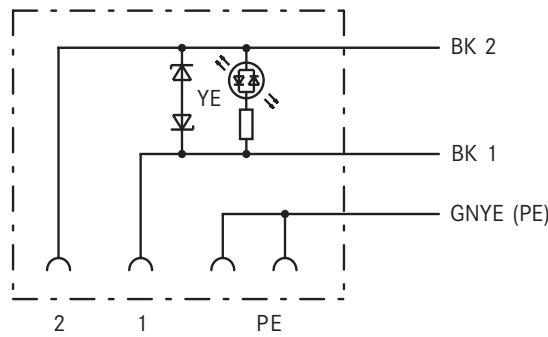

S/A cable: 3-pos., valve connector on free conductor end

Benefits

- Cost-saving due to quick and easy installation
- Space-saving due to compact dimensions
- Fast and easy error tracking
- Standardised interfaces

Application range

- Automation technology
- Mechanical engineering
- Nacelle
- Limit switch

Product features

- 3-pin valve connector
- With protective circuit (Z diode) PE-bridged
- With LED status indicator (yellow)
- The cables have marker carriers
- Free of substances that could hinder paint or varnish

Approvals



Design

- Cable design: 3 x 0.5 mm<sup>2</sup> (28 x 0.15 mm)
- Core colours: black 1, black 2, green/yellow
- Outer sheath: PUR, halogen-free
- Outer sheath colour: black (RAL 7021)
- Outer diameter: 4.5 mm
- Suitable for drag chains

Technical data



Protection rating  
IP 67



Ambient temperature (operation)  
Valve connector  
-20°C to +85°C  
Cable, flexible installation  
-15°C to +80°C  
Cable, fixed installation  
-40°C to +80°C

Contact material  
CuSn

Contact surface material  
Ag

Coding  
A - Standard

Article number	Article designation	Length (m)	Nominal voltage U <sub>N</sub> (V)	Nominal current I <sub>N</sub> in (A)	Status display	PU
<b>Valve connector type A (18 mm)</b>						
22260584	AB-C3- 2,0PUR-A-1L-S	2	24	4	1 LED	1
22260576	AB-C3- 5,0PUR-A-1L-S	5	24	4	1 LED	1
22260577	AB-C3-10,0PUR-A-1L-S	10	24	4	1 LED	1
<b>Valve connector type B (10 mm)</b>						
22260585	AB-C3- 2,0PUR-B-1L-S	2	24	4	1 LED	1
22260578	AB-C3- 5,0PUR-B-1L-S	5	24	4	1 LED	1
22260579	AB-C3-10,0PUR-B-1L-S	10	24	4	1 LED	1
<b>Valve connector type BI (11 mm)</b>						
22260586	AB-C3- 2,0PUR-BI-1L-S	2	24	4	1 LED	1
22260580	AB-C3- 5,0PUR-BI-1L-S	5	24	4	1 LED	1
22260581	AB-C3-10,0PUR-BI-1L-S	10	24	4	1 LED	1
<b>Valve connector type C (8 mm)</b>						
22260587	AB-C3- 2,0PUR-C-1L-S	2	24	4	1 LED	1
22260582	AB-C3- 5,0PUR-C-1L-S	5	24	4	1 LED	1
22260583	AB-C3-10,0PUR-C-1L-S	10	24	4	1 LED	1
<b>Valve connector type CI (9.4 mm)</b>						
22260588	AB-C3- 2,0PUR-CI-1L-S	2	24	4	1 LED	1
22260574	AB-C3- 5,0PUR-CI-1L-S	5	24	4	1 LED	1
22260575	AB-C3-10,0PUR-CI-1L-S	10	24	4	1 LED	1
22260921						

Unless specified otherwise, the shown product values are nominal values. Detailed values (e.g. tolerances) are available upon request.  
Copper price basis: inclusive of copper. Refer to Appendix T17 for the definition and calculation of copper-related surcharges.  
Photographs are not to scale and do not represent detailed images of the respective products.  
For detailed technical information please refer to the data sheet ([www.lappautomation.com](http://www.lappautomation.com))  
For the UNITRONIC® field bus type code, please see table T6



## DeviceNet/CANopen Cable, M 12 connector on free conductor end

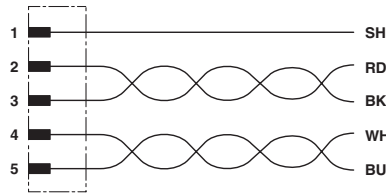

**Info**

- Pre-assembled DeviceNet/CANopen data network cable

### DeviceNet/CANopen Cable, M12 connector on free conductor end

**Benefits**

- Cost-effective and efficient wiring of field bus installations, sensors and actuators
- Space-saving due to compact dimensions
- Robust design
- Standardised interfaces

**Application range**

- Automation technology
- Mechanical engineering
- Limit switch
- Temp. sensor

**Product features**

- 5-pin DeviceNet/CANopen cable, shielded
- M12 A-coded with quick-locking system
- Straight socket or straight plug to free conductor end
- The cables have marker carriers
- Suitable for drag chains

**Approvals**



**Design**

- Halogen-free PUR, screened cable
- Fixed flexible control cable
- Design (signal line): 19 x 0.12 mm
- Core colours: red-black, blue-white

**Suitable connectors**

- EPIC® Data Connectors
- Field mountable S/A connectors M12

**Technical data**



**Protection rating**  
IP65/IP67/IP69K



**Ambient temperature (operation)**  
Plug/socket  
-25°C to +90°C (PUR/PVC)  
Cable, flexible installation  
-20°C to +80°C  
Cable, fixed installation  
-40°C to +80°C

**Contact surface material**  
Ni/Au

**Coding**  
A - Standard

**Knurl material**  
Zinc die-cast, nickel-plated

**Gripping body material**  
TPU, flame-retardant, self-extinguishing

**Outer cable diameter**  
6,7 mm



**Conductor cross-section**  
0,2 mm²

**Outer sheath, colour**  
violet (RAL 4001)

**Outer sheath, material**  
PUR

Article number	Article designation	Length (m)	Nominal voltage U <sub>N</sub> (V)	Nominal current I <sub>N</sub> in (A)	Number of pins	PU
<b>5-pin straight connector</b>						
22260789	AB-DN-M12MS-2,0PUR	2	60	4	5	1
22260790	AB-DN-M12MS-5,0PUR	5	60	4	5	1
22260791	AB-DN-M12MS-10,0PUR	10	60	4	5	1
<b>5-pin straight socket</b>						
22260792	AB-DN-2,0PUR-M12FS	2	60	4	5	1
22260793	AB-DN-5,0PUR-M12FS	5	60	4	5	1
22260794	AB-DN-10,0PUR-M12FS	10	60	4	5	1

Unless specified otherwise, the shown product values are nominal values. Detailed values (e.g. tolerances) are available upon request.

Copper price basis: inclusive of copper. Refer to Appendix T17 for the definition and calculation of copper-related surcharges.

Customised cable lengths are available upon request.

Photographs are not to scale and do not represent detailed images of the respective products.

For detailed technical information please refer to the data sheet ([www.lappautomation.com](http://www.lappautomation.com))

For the UNITRONIC® field bus type code, please see table T6

## S/A DeviceNet/CANopen cable, M12 connector on M12 socket



**Info**

- DeviceNet/CANopen data network cable, ready for connection

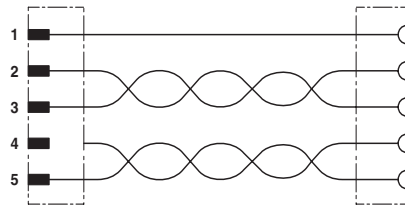

S/A DeviceNet/CANopen cable, M12 connector on M12 socket

**Benefits**

- Cost-effective and efficient wiring of field bus installations, sensors and actuators
- Space-saving due to compact dimensions
- Fast and easy error tracking
- Standardised interfaces

**Application range**

- Automation technology
- Mechanical engineering
- Limit switch
- Temp. sensor

**Product features**

- 5-pin DeviceNet/CANopen cable, shielded
- M12 A-coded with quick-locking system
- Straight plug to straight socket
- The cables have marker carriers
- Suitable for drag chains

**Approvals**



**Design**

- Halogen-free PUR, screened cable
- Fixed flexible control cable
- Design (signal line): 19 x 0.12 mm
- Design (voltage line): 19 x 0.15 mm
- Core colours: red-black, blue-white

**Technical data**

	<b>Protection rating</b> IP65/IP67/IP69K
	<b>Ambient temperature (operation)</b> Plug/socket -25°C to +90°C (PUR/PVC) Cable, flexible installation -20°C to +80°C Cable, fixed installation -40°C to +75°C
	<b>Contact surface material</b> Ni/Au
	<b>Coding</b> A - Standard
	<b>Knurl material</b> Zinc die-cast, nickel-plated
	<b>Gripping body material</b> TPU, flame-retardant, self-extinguishing
	<b>Outer cable diameter</b> 6,7 mm
	<b>Conductor cross-section</b> 0,2 mm <sup>2</sup>
	<b>Outer sheath, colour</b> violet (RAL 4001)
	<b>Outer sheath, material</b> PUR

Article number	Article designation	Length (m)	Nominal voltage U <sub>n</sub> (V)	Nominal current I <sub>n</sub> (A)	Number of pins	PU
<b>Straight connector to straight socket</b>						
22260795	AB-DN-M12MS-0,3PUR-M12FS	0.3	60	4	5	1
22260796	AB-DN-M12MS-1,0PUR-M12FS	1	60	4	5	1
22260797	AB-DN-M12MS-2,0PUR-M12FS	2	60	4	5	1
22260798	AB-DN-M12MS-5,0PUR-M12FS	5	60	4	5	1
22260799	AB-DN-M12MS-10,0PUR-M12FS	10	60	4	5	1

Unless specified otherwise, the shown product values are nominal values. Detailed values (e.g. tolerances) are available upon request.  
 DeviceNet is a registered trademark of ODVA  
 Customised cable lengths are available upon request.  
 Photographs are not to scale and do not represent detailed images of the respective products.  
 For detailed technical information please refer to the data sheet ([www.lappautomation.com](http://www.lappautomation.com))  
 For the UNITRONIC® field bus type code, please see table T6

New

# UNITRONIC® BUS PB 105 plus 1X2X0,64

LAPP KABEL STÜTTGART UNITRONIC® BUS PB 105



Info

- Cables for bus systems PROFIBUS-DP/FMS/FIP
- Lapp Kabel is a member of the PROFIBUS User Organisation (PNO)

**Benefits**

- No need for additional cable protection against high temperatures
- High temperature resistance

**Application range**

- For installation in hollow shaft between gear units and pitch system
- Suitable for fixed installation and occasionally flexible use in high temperature areas
- Slip ring – Pitch connection

**Product features**

- Permanent load up to +105 °C, temporary load +120 °C

**Approvals**

- In accordance with DIN 19245 and EN 50170, e.g. for SIEMENS SIMATIC NET, also suitable for FIP (Factory Instrumentation Protocol)

**Design**

- Stranded conductor, 7-wire, bare
- Core insulation: polypropylene (PP)
- Overall screening with copper braid and plastic-laminated aluminium foil
- Outer sheath: TPE-based

**Technical data**



**Mutual capacitance**  
(800 Hz): max. 30 nF/km



**Peak operating voltage**  
(not for power applications) 250 V



**Minimum bending radius**  
Fixed installation: 45 mm once  
Flexing: 65 mm



**Test voltage**  
Core/core: 1500 V eff  
Core/screen: 1500 V eff.



**Temperature range**  
Fixed installation: -40 °C to +105 °C  
Short-term: up to +120 °C



**Characteristic impedance**  
(3 - 20 MHz): 150 ± 15 Ohm

Article number	Article designation	Number of pairs and conductor diameter (mm)	Outer diameter (mm)	Copper index (kg/km)
2170635	UNITRONIC BUS PB 105 plus	1x2x0,64	8.0	30.1

Photographs are not to scale and do not represent detailed images of the respective products.

**New**

**Info**

- For PROFINET applications (D-coded)
- Extended temperature range

**Benefits**

- No need for additional cable protection against high temperatures
- High temperature resistance
- Slip ring – Pitch connection

**Application range**

- For installation in hollow shaft between gear units and pitch system
- Suitable for fixed installation and occasionally flexible use in high temperature areas

**Product features**

- Optimum EMC protection
- Permanent load up to +105°C, temporary load +120°C

# ETHERLINE Cat.5e 105 plus 2x2xAWG22/7



**Approvals**



- Electrical requirements acc. to IEC 61156-5

**Design**

- Stranded conductor, 7-wire, bare
- Core insulation: PE
- Overall screening with copper braid and plastic-laminated aluminium foil
- Outer sheath: TPE-based
- AWG22: colour: yellow-green (RAL 6018)

**Technical data**

**Minimum bending radius**  
Fixed installation: 10 x outer diameter  
Flexing: 15 x outer diameter

**Temperature range**  
Occasionally flexing: -30°C to +105°C  
Fixed installation: -40°C to +105°C

**Characteristic impedance**  
100 Ohm +- 15%

Article number	Article designation	Number of pairs and AWG per conductor	Outer diameter (mm)	Copper index (kg/km)
2170636	ETHERLINE Cat.5e 105 plus	2x2xAWG22/7	6.2	30.4

Photographs are not to scale and do not represent detailed images of the respective products.

**Info**

- Industrial Ethernet cable
- Cat.5e

**Benefits**

- Very low installation cost due to the use of Ethernet cables
- Screened against interference

**Application range**

- 2pair: 10/100 Mbit/s for Industrial Ethernet
- 4pair: 10/100/1000 Mbit/s for Industrial Ethernet
- Seamless communication from the sensor/ actuator level to the Internet
- Industrial use
- Suitable for fixed installation in dry and damp environment
- Nacelle
- Top/Bottom Box

**Product features**

- High-quality, double screening ensures high transmission reliability in areas with electromagnetic interference
- PUR outer sheath is highly resistant to mineral oils and abrasion
- Halogen-free and flame-retardant FRNC outer sheath

**Approvals**



**Design**

- Solid conductor
- Core insulation made of foam skin
- SF/UTP: copper braid and foil screening as overall screening

**Technical data**

**Peak operating voltage**  
(not for power applications) 125 V

**Minimum bending radius**  
Fixed installation: see data sheet

**Test voltage**  
Core/core: 1000 V  
Core/screen: 500 V

**Temperature range**  
During installation: -5 °C to +60 °C  
Operation: see data sheet

**Characteristic impedance**  
100 Ohm +- 15%

- Outer sheath as either PUR or LSZH
- Colour: water blue (RAL 5021)
- 2 or 4-pair version

Article number	Article designation	Number of pairs and AWG per conductor	Outer diameter (mm)	Copper index (kg/km)	Weight (kg/km)
<b>2-pair version</b>					
<b>Halogen-free compound</b>					
2170280	ETHERLINE® H CAT.5e	2 x 2 x AWG24/1	5.8	22.0	45
<b>PUR outer sheath, halogen-free</b>					
2170281	ETHERLINE® P CAT.5e	2 x 2 x AWG24/1	5.8	22.0	53
<b>4-pair version</b>					
<b>Halogen-free compound</b>					
2170296	ETHERLINE® H CAT.5e	4 x 2 x AWG24/1	6.3	32.0	54
2170298	ETHERLINE® H-H CAT.5e	4 x 2 x AWG24/1	6.0 / 7.5	32.0	80
<b>Outer sheath: PUR, halogen-free</b>					
2170297	ETHERLINE® P CAT.5e	4 x 2 x AWG24/1	6.3	32.0	62

Unless specified otherwise, the shown product values are nominal values. Detailed values (e.g. tolerances) are available upon request. Please find our standard lengths at: [www.lappkabel.de/en/cable-standardlengths](http://www.lappkabel.de/en/cable-standardlengths)  
Packaging size: coil ≤ 30 kg or ≤ 250 m, otherwise drum  
Detailed data sheets are available upon request. Please specify the type/dimensions of the required cable.  
Photographs are not to scale and do not represent detailed images of the respective products.

For current information see: [www.lappgroup.com](http://www.lappgroup.com)

ÖLFLEX®

UNITRONIC®

ETHERLINE®

HITRONIC®

EPIC®

SKINTOP®

SILVYN®

FLEXIMARK®

ACCESSORIES

# ETHERLINE® Cat.5e FLEX

## Flexible use



### Info

- Industrial Ethernet cable
- Cat.5e
- Only for patch cable applications (max. 60 m)

### Benefits

- For directly connecting two electric components
- Very low installation cost due to the use of Ethernet cables
- Screened against interference

### Application range

- Suitable for fixed installation in dry and damp rooms
- 2pair: 10/100 Mbit/s for Industrial Ethernet
- 4pair: 10/100/1000 Mbit/s for Industrial Ethernet
- For flexible applications (7-wire stranded conductor)
- Nacelle
- Top/Bottom Box
- Pitch

### Product features

- High-quality, double screening ensures high transmission reliability in areas with electromagnetic interference
- Halogen-free and flame-retardant FRNC outer sheath
- PUR outer sheath is highly resistant to mineral oils and abrasion

### Design

- Stranded conductor, 7-wire, bare
- Core insulation made of foam skin
- SF/UTP: copper braid and foil screening as overall screening
- Outer sheath as either PUR or LSZH
- Colour: water blue (RAL 5021)
- 2 or 4-pair version

### Technical data



**Peak operating voltage**  
(not for power applications) 125 V



**Minimum bending radius**  
See data sheet



**Test voltage**  
Core/core: 1000 V  
Core/screen: 500 V



**Temperature range**  
During installation: -5 °C to +60 °C  
Operation: see data sheet



**Characteristic impedance**  
100 Ohm +/- 15%

Article number	Article designation	Number of pairs and AWG per conductor	Outer diameter (mm)	Copper index (kg/km)	Weight (kg/km)
<b>Outer sheath: PUR, halogen-free</b>					
2170300	ETHERLINE® P Flex CAT.5e	4 x 2 x AWG26/7	6.1	25.0	54
<b>4-pair version</b>					
<b>Halogen-free compound</b>					
2170299	ETHERLINE® H Flex CAT.5e	4 x 2 x AWG26/7	6.1	25.0	48
<b>PUR outer sheath, halogen-free</b>					
2170284	ETHERLINE® P Flex CAT.5e	2 x 2 x AWG26/7	5.8	19.0	45
<b>2-pair version</b>					
<b>Halogen-free compound</b>					
2170283	ETHERLINE® H Flex CAT.5e	2 x 2 x AWG26/7	5.4	19.0	43

Unless specified otherwise, the shown product values are nominal values. Detailed values (e.g. tolerances) are available upon request.

Please find our standard lengths at: [www.lappkabel.de/en/cable-standardlengths](http://www.lappkabel.de/en/cable-standardlengths)

Packaging size: coil ≤ 30 kg or ≤ 250 m, otherwise drum

Detailed data sheets are available upon request. Please specify the type/dimensions of the required cable.

Photographs are not to scale and do not represent detailed images of the respective products.

**Info**

- Industrial Ethernet cable
- For highly flexible applications
- Only for patch cable applications (max. 60 m)

**Benefits**

- Very low installation cost due to the use of Ethernet cables
- Screened against interference
- Seamless communication from the sensor/ actuator level to the Internet

**Application range**

- 2pair: 10/100 Mbit/s for Industrial Ethernet
- 4pair: 10/100/1000 Mbit/s for Industrial Ethernet
- Industrial use
- Nacelle
- Top/Bottom Box
- Pitch

**Product features**

- High-quality, double screening ensures high transmission reliability in areas with electromagnetic interference
- PUR outer sheath is highly resistant to mineral oils and abrasion

**Design**

- Braided conductor, 19-wire
- Inner sheath: thermoplastic elastomer, halogen-free
- SF/UTP: copper braid and foil screening as overall screening
- PUR outer sheath
- Colour: water blue (RAL 5021)
- 2 or 4-pair version

**ETHERLINE® Cat.5e FD**

Highly flexible application

**Technical data**

- Peak operating voltage**  
(not for power applications) 125 V
- Minimum bending radius**  
Flexing: 15 x outer diameter  
Fixed installation: 8 x outer diameter
- Test voltage**  
Core/core: 1000 V  
Core/screen: 500 V
- Temperature range**  
Flexing: -20 °C to +70 °C  
Fixed installation: -30°C to +80°C
- Characteristic impedance**  
100 Ohm +- 15%

Article number	Article designation	Number of pairs and AWG per conductor	Outer diameter (mm)	Copper index (kg/km)	Weight (kg/km)
<b>4-pair version</b>					
2170489	ETHERLINE® FD P CAT.5e	4 x 2 x AWG26/19	6.3	27.0	54
<b>2-pair version</b>					
2170289	ETHERLINE® FD P CAT.5e	2 x 2 x AWG26/19	6.1	20.0	48

Unless specified otherwise, the shown product values are nominal values. Detailed values (e.g. tolerances) are available upon request. Please find our standard lengths at: [www.lappkabel.de/en/cable-standardlengths](http://www.lappkabel.de/en/cable-standardlengths)  
Packaging size: Coil 100 m; Drum (500; 1000) m  
Detailed data sheets are available upon request. Please specify the type/dimensions of the required cable.  
Photographs are not to scale and do not represent detailed images of the respective products.

**Info**

- Suitable for outdoor use and direct burial
- Usable on the roads
- CAT.5-Performance

**Benefits**

- Very low installation cost due to the use of Ethernet cables
- Additional application options thanks to suitability for outdoor use, UV-resistant
- Good flexibility - easy installation with tight space requirements
- Screened against interference
- Easy to coil for mobile use

**Application range**

- Suitable for the transfer of audio signals (ETHERSOUND), light control signals (DMX over Ethernet)
- Only for patch cable applications (max. 60 m)
- Nacelle

**Product features**

- ETHERLINE® CAT.5 FD BK is a highly flexible, halogen-free, CATEGORY 5 high-speed data transmission cable, which specifically developed for road environments.
- Complies with standards EIA/TIA-568, TSB-36 and ISO/IEC IS 11801

**Approvals**



**Design**

- Bare stranded copper wire, 26AWG (19 x 0.10), (0.14 mm<sup>2</sup>)
- Insulation: foam skin, max. core diameter 1.0 mm
- Twisting: 2 twisted-pair cores, stranding from 4 pairs

**ETHERLINE® Cat.5 FD BK**

The Ethernet cable for installation in events



**Technical data**

- Minimum bending radius**  
Flexing: 15 x outer diameter  
Fixed installation: 10 x outer diameter
- Temperature range**  
Flexing: -5°C to +50°C  
Fixed installation: -40°C to +70°C
- Characteristic impedance**  
100 Ohm +- 15%

- Inner sheath: halogen-free TPE compound
- Screening: braided tinned-copper wires, coverage of 85% ± 5
- Outer sheath: halogen-free PUR, black

Article number	Number of pairs and AWG per conductor	Outer diameter (mm)	Copper index (kg/km)	Weight (kg/km)
CE217489	4x2xAWG26/19	6.3	27.0	54

Unless specified otherwise, the shown product values are nominal values. Detailed values (e.g. tolerances) are available upon request. Copper price basis: EUR 150/100kg. Refer to Appendix T17 for the definition and calculation of copper-related surcharges. Standard lengths: (100; 500; 1000) m  
Packaging size: coil ≤ 30 kg or ≤ 250 m, otherwise drum  
Please specify the preferred type of packaging (e.g. 1 x 500 m drum or 5 x 100 m coils).  
Photographs are not to scale and do not represent detailed images of the respective products.

New

# UNITRONIC® LAN 200 - Cat.5e



**Info**

- EIA = Electronic Industries Associations
- TIA = Telecommunication Industries Association
- TSB = Technical Systems Bulletin

**Benefits**

- LAN cables for structured building cabling according to EN 50173 and ISO/IEC 11801

**Application range**

- Mainly used where the terminal density is very high
- Cable length in tertiary area (horizontal area, floor) should not exceed a length of 100 m in accordance with the ISO/IEC 11801 and EN 50173 standards (90 m in cable duct + 10 m in working area)

**Product features**

- Transfer of digital and analogue data signals
- The characteristic impedance of this cable is 100 Ohm ± 15 %
- IEEE 802.3: 10/100/1000Base-T
- IEEE 802.5: ISDN; FDDI; ATM

**Approvals**



- Class D in ISO/IEC 11801 standard corresponds to CAT.5
- LAN CAT.5e cables from Lapp Kabel for "Structured Cabling Systems" meet the requirements in accordance with EIA/TIA-568 and TSB36, as well as ISO/IEC 11801 or EN 50173 (Class D).

**Design**

- U/UTP: no overall or pair shielding
- F/UTP: foil screening as overall screening
- SF/UTP: copper braid and foil screening as overall screening
- Solid conductor
- Outer sheath either as PVC or LSZH

**Technical data**

- Minimum bending radius**  
during installation: 8 x outer diameter  
Fixed installation: 4 x outer diameter
- Temperature range**  
Operating temperature: -20°C to +60°C  
During installation: 0 °C to +50 °C
- Characteristic impedance**  
100 Ohm +- 15%

Article number	Article designation	Number of pairs and AWG per conductor	Outer diameter (mm)	Copper index (kg/km)	Weight (kg/km)
<b>PVC version</b>					
2170125	200 U/UTP Cat.5e	4 x 2 x AWG24/1	5.6	17.0	33
2170126	200 F/UTP Cat.5e	4 x 2 x AWG24/1	6.4	18.0	39
2170128	200 SF/UTP Cat.5e	4 x 2 x AWG24/1	6.7	32.0	49
<b>Halogen-free versions</b>					
2170185	200 U/UTP Cat.5e LSZH	4 x 2 x AWG24/1	5.6	17.0	33
2170138	200 SF/UTP Cat.5e LSZH	4 x 2 x AWG24/1	6.7	32.0	49

Unless specified otherwise, the shown product values are nominal values. Detailed values (e.g. tolerances) are available upon request.  
 Copper price basis: EUR 150/100kg. Refer to Appendix T17 for the definition and calculation of copper-related surcharges.  
 Please find our standard lengths at: [www.lappkabel.de/en/cable-standardlengths](http://www.lappkabel.de/en/cable-standardlengths)  
 Packaging size: Coil 100 m; Drum (500; 1000) m  
 Detailed data sheets are available upon request. Please specify the type/dimensions of the required cable.  
 Photographs are not to scale and do not represent detailed images of the respective products.

**Accessories**

- Connector RJ45 CAT.5 Hirose TM11 refer to main catalogue 2012 page 418
- Connector RJ45 CAT.5 Stewart SS37 refer to main catalogue 2012 page 418
- Field-Terminable Connector RJ45 CAT.5e FM45 refer to main catalogue 2012 page 418
- DATA STRIP stripping tool refer to main catalogue 2012 page 907

ÖLFLEX®  
 UNITRONIC®  
 ETHERLINE®  
 HITRONIC®  
 EPIC®  
 SKINTOP®  
 SILVYN®  
 FLEXIMARK®  
 ACCESSORIES

**New**

## UNITRONIC® LAN 250 - Cat.6

**Info**

- EIA = Electronic Industries Associations
- TIA = Telecommunication Industries Association
- TSB = Technical Systems Bulletin



**Benefits**

- LAN cables for structured building cabling according to EN 50173 and ISO/IEC 11801

**Application range**

- Mainly used where the terminal density is very high

**Product features**

- Transfer of digital and analogue data signals
- LAN Cat.6 cables are specified up to 350 MHz
- The characteristic impedance of this cable is 100 Ohm ± 15 %
- IEEE 802.3: 10/100/1000Base-T
- IEEE 802.5: ISDN; FDDI; ATM

**Approvals**



- Class E out of the standard ISO/IEC 11801 corresponds to CAT.6
- LAN CAT.6 cables from Lapp Kabel for "Structured Cabling Systems" meet the requirements in accordance with EIA/TIA-568 and TSB36, as well as ISO/IEC 11801 or EN 50173 (Class E - permanent link).

**Design**

- U/UTP: no overall or pair shielding
- F/UTP: foil screening as overall screening
- Solid conductor
- Outer sheath either as PVC or LSZH

**Technical data**

- Minimum bending radius**  
during installation: 8 x outer diameter  
Fixed installation: 4 x outer diameter
- Temperature range**  
Operating temperature: -20°C to +60°C  
During installation: 0 °C to +50 °C
- Characteristic impedance**  
100 Ohm +- 15%

Article number	Article designation	Number of pairs and AWG per conductor	Outer diameter (mm)	Copper index (kg/km)	Weight (kg/km)
<b>PVC versions</b>					
2170186	250 U/UTP Cat.6	4 x 2 x AWG24/1	6.5	18.0	46
<b>Halogen-free versions</b>					
2170193	250 U/UTP Cat.6 LSZH	4 x 2 x AWG24/1	6.5	18.0	46
2170194	250 F/UTP Cat.6 LSZH	4 x 2 x AWG24/1	7.5	19.0	54

Unless specified otherwise, the shown product values are nominal values. Detailed values (e.g. tolerances) are available upon request.  
Please find our standard lengths at: [www.lappkabel.de/en/cable-standardlengths](http://www.lappkabel.de/en/cable-standardlengths)  
Packaging size: Coil 100 m; Drum (500; 1000) m  
Detailed data sheets are available upon request. Please specify the type/dimensions of the required cable.  
Photographs are not to scale and do not represent detailed images of the respective products.

ÖLFLEX®

UNITRONIC®

ETHERLINE®

HITRONIC®

EPIC®

SKINTOP®

SILVYN®

FLEXIMARK®

ACCESSORIES



Components for building-networking

LAN cables for structured building cabling

New

# UNITRONIC® LAN 1200 S/FTP Cat.7<sub>A</sub>

LAPP KABEL STUÏTGART UNITRONIC® LAN S/FTP 1200 MHz Cat.7A



LAPP KABEL STUÏTGART UNITRONIC® LAN S/FTP 1200 MHz Cat.7A

**Benefits**

- LAN cables for structured building cabling according to EN 50173 and ISO/IEC 11801

**Application range**

- Mainly used where the terminal density is very high
- Cable length in tertiary area (horizontal area, floor) should not exceed a length of 100 m in accordance with the ISO/IEC 11801 and EN 50173 standards (90 m in cable duct + 10 m in working area)

**Product features**

- Transfer of digital and analogue data signals
- The cable is specified for up to 1.2 GHz
- The characteristic impedance of this cable is 100 Ohm ± 15 %

- IEEE 802.3: 10/100/1000Base-T, 10GBase-T
- IEEE 802.5: ISDN; FDDI; ATM; cable sharing
- IEEE 802.3at: suitable for PoE

**Approvals**



- LAN Cat.7<sub>A</sub> cables from Lapp Kabel for "Structured Cabling Systems" meet the requirements in accordance with EIA/TIA-568 and TSB36 as well as ISO/IEC 11801 or EN 50173 (Class F<sub>A</sub> - permanent link).
- Exceeds the requirements of EN 50173 and ISO/IEC 11801 standards

**Design**

- Solid bare copper wire AWG22
- Cellular polyolefin core insulation, max. core diameter 1.6 mm



**Info**

- Complies with the EN 50173 and ISO/IEC 11801 standards

**Technical data**



**Minimum bending radius**  
during installation: 8 x outer diameter  
Fixed installation: 4 x outer diameter



**Temperature range**  
Operating temperature: -20°C to +60°C  
During installation: 0 °C to +50 °C



**Characteristic impedance**  
100 Ohm ± 15%

- Pair screen made of aluminium-lined plastic foil, overall screening made of tinned-copper braiding
- Outer sheath: halogen-free, flame-retardant compound
- Colour: yellow (RAL 7032)

Article number	Article designation	Number of pairs and AWG per conductor	Outer diameter (mm)	Copper index (kg/km)	Weight (kg/km)
2170615	1200 S/FTP Cat.7 <sub>A</sub> LSZH	4 x 2 x AWG22/1	8.1	34.0	66

Copper price basis: EUR 150/100kg. Refer to Appendix T17 for the definition and calculation of copper-related surcharges.

Please find our standard lengths at: [www.lappkabel.de/en/cable-standardlengths](http://www.lappkabel.de/en/cable-standardlengths)

Packaging size: Drum

Detailed data sheets are available upon request. Please specify the type/dimensions of the required cable.

Photographs are not to scale and do not represent detailed images of the respective products.

**Accessories**

- Multipurpose shears A and B refer to main catalogue 2012 page 902
- DATA STRIP stripping tool refer to main catalogue 2012 page 907

New

# UNITRONIC® LAN 1500 S/FTP Cat.7<sub>A</sub>

LAPP KABEL STUÏTGART UNITRONIC® LAN S/FTP 1500 MHz Cat.7A



LAPP KABEL STUÏTGART UNITRONIC® LAN S/FTP 1500 MHz Cat.7A

**Benefits**

- LAN cables for structured building cabling according to EN 50173 and ISO/IEC 11801

**Application range**

- Mainly used where the terminal density is very high

**Product features**

- Transfer of digital and analogue data signals
- Cable is specified for up to 1.5 GHz
- The characteristic impedance of this cable is 100 Ohm ± 15 %
- IEEE 802.3: 10/100/1000Base-T, 10GBase-T
- IEEE 802.5: ISDN; FDDI; ATM; cable sharing
- IEEE 802.3at: suitable for PoE, VoIP

**Approvals**

- LAN Cat.7<sub>A</sub> cables from Lapp Kabel for "Structured Cabling Systems" meet the requirements in accordance with EIA/TIA-568 and TSB36 as well as ISO/IEC 11801 or EN 50173 (Class F<sub>A</sub> - permanent link).
- Exceeds the requirements of EN 50173 and ISO/IEC 11801 standards

**Design**

- Solid bare copper wire AWG22
- Cellular polyolefin core insulation, max. core diameter 1.6 mm
- Pair screen made of aluminium-lined plastic foil, overall screening made of tinned-copper braiding



**Info**

- Complies with the EN 50173 and ISO/IEC 11801 standards

**Technical data**



**Minimum bending radius**  
during installation: 8 x outer diameter  
Fixed installation: 4 x outer diameter



**Temperature range**  
Operating temperature: -20°C to +60°C  
During installation: 0 °C to +50 °C



**Characteristic impedance**  
100 Ohm ± 15%

- Outer sheath: halogen-free, flame-retardant compound
- Colour: yellow (RAL 7032)

Article number	Article designation	Number of pairs and AWG per conductor	Outer diameter (mm)	Copper index (kg/km)
2170199	1500 S/FTP Cat.7 <sub>A</sub> LSZH	4 x 2 x AWG22/1	8.5	42.0

Unless specified otherwise, the shown product values are nominal values. Detailed values (e.g. tolerances) are available upon request.

Please find our standard lengths at: [www.lappkabel.de/en/cable-standardlengths](http://www.lappkabel.de/en/cable-standardlengths)

Packaging size: Coil 100 m; Drum (500; 1000) m

Detailed data sheets are available upon request. Please specify the type/dimensions of the required cable.

Photographs are not to scale and do not represent detailed images of the respective products.

ÖLFLEX®  
UNITRONIC®  
ETHERLINE®  
HITRONIC®  
EPIC®  
SKINTOP®  
SILVYN®  
FLEXIMARK®  
ACCESSORIES

**Two different connection types are used with fibre optic cables:**

1. Detachable connections realised with plug connectors. In this case it is necessary to attach a plug to a glass fibre. This calls for trained personnel and expensive special tools.

2. Non-detachable connections created by directly splicing two glass fibres together. To do this requires highly trained personnel and very expensive equipment. If the necessary resources are used only occasionally, the investment is very unlikely to pay for itself.

**The answer: The Lapp fibre trunk system.**

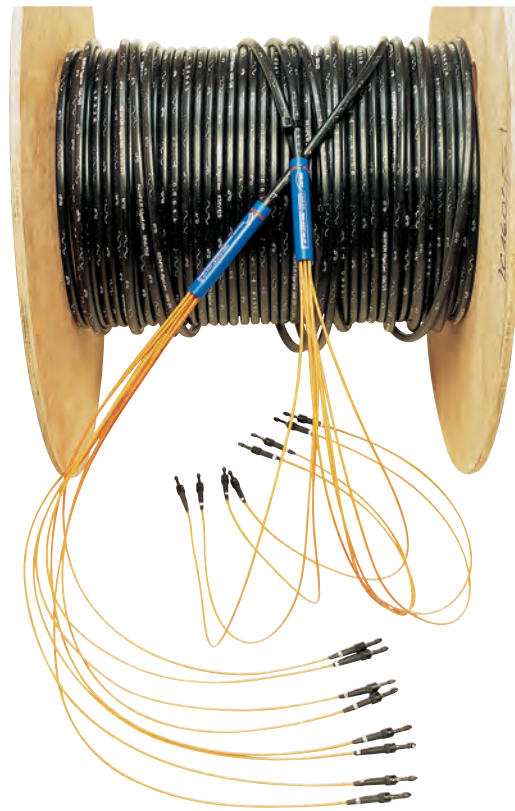

**Advantages**

Using a trunk system offers you the following advantages:

- No costs of special equipment
- No need for highly trained personnel
- Uniform quality thanks to manufacture under laboratory conditions
- Installation is quick, thereby saving costs
- No need to carry out measurements on the cable run, comes with OTDR test certificate
- Fan-out elements also available in IP67

**Requirements**

The following data are needed to produce your tailor-made trunk system:

- Length of cable run (effective run +3 to 5 metres reserve on either side)
- Fibre type (SM 9 µm, MM 50 µm or 62.5 µm)
- Number of fibres (2, 4, 6, 8 ... to 48 fibres)
- Plug type (ST, SC, Bachmann Electronic GmbH .... including mixed)
- Cable type (indoor, outdoor, rodent protection etc.)
- Special type on request

New

# HITRONIC® TORSION



Info

- A/J-V(ZN)H11Y
- Breakout cable designed to withstand high torsional stresses

Benefits

- Designed to withstand high torsion in the windmill drip loop
- Suitable for field assembly
- Easy to install due to the compact design, high flexibility, robust sheath and small bending radii
- Zero electromagnetic interference as the cable contains no metal

Application range

- For indoor and outdoor use
- As a link between moving parts
- TORSION = ±150° /m
- Tower / Loop cable

Product features

- Based on military norm MIL-C-85045
- Torsion-resistant and very flexible
- Flame-retardant and halogen-free
- Mechanically robust

Approvals



Design

- 2.5 mm tight-buffered sub-cable with LSZH sheath
- Aramid yarns as strain relief
- PUR outer sheath
- Colour: black (RAL 9005)

Technical data



Optical fibre type

Core material: Glass  
Cladding material: Glass



Temperature range

Occasional flexing: -30°C to +70°C  
Fixed installation: -40°C to +70°C



Permissible bending radius

Static: ≥ 15 x outer diameter  
Dynamic: ≥ 20 x outer diameter

Article number	Outer diameter (mm)
<b>Multimode G 50 OM3</b>	
26310302	8.4 mm
26310304	8.4 mm
26310308	11.6 mm
26310312	12.4 mm
<b>Multimode G 50 OM2</b>	
26310202	8.4 mm
26310204	8.4 mm
26310208	11.6 mm
26310212	12.4 mm
<b>Multimode G 62.5 OM1</b>	
26310102	8.4 mm
26310104	8.4 mm
26310108	11.6 mm
26310112	12.4 mm
<b>Single-mode E 9 OS2</b>	
26310902	8.4 mm
26310904	8.4 mm
26310908	11.6 mm
26310912	12.4 mm

Photographs are not to scale and do not represent detailed images of the respective products.

ÖLFLEX®  
UNITRONIC®  
ETHERLINE®  
HITRONIC®  
EPIC®  
SKINTOP®  
SILVYN®  
FLEXIMARK®  
ACCESSORIES

# HITRONIC® BUS PCF DUPLEX indoor + outdoor

**Info**

- Polymer-cladded fibre (PCF)
- Standard designation (indoor): J-V(ZN)H11Y 2K200/230
- Standard designation (outdoor): AT-VQ(ZN)HB2Y 2K200/230

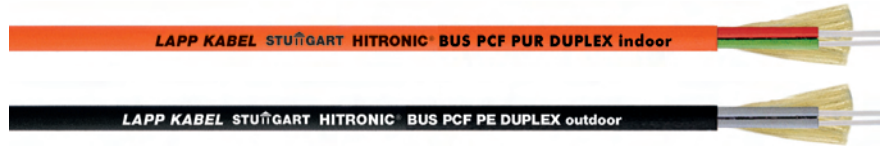

**Benefits**

- Data transmission up to approx. 500 m
- To be used for direct connector assembly
- Easy to assemble
- EMC protection
- High mechanical stability

**Application range**

- Can be used in industrial environments, for data transmission in field bus systems, such as PROFIBUS, INTERBUS etc.
- Inside Top/Bottom box
- Tower cable

**Product features**

- Data transmission up to approx. 500 m
- Usable wavelengths: 650 nm and 850 nm
- In Duplex version
- Good resistance to oil, petrol, acids and alkalis
- PE/PUR outer sheath is halogen-free

**Approvals**



**Design**

- 2 step-index fibres PCF 200/230 (Polymer Cladded Fibre)
- DUPLEX cable with fibre core made of quartz glass and a fluorinated polymer (plastic, ETFE) sheath
- Outer sheath: PUR for indoors; PE for outdoors

**Technical data**

**Dimensions**  
PCF 200/230 µm

**Fibre type**  
Step index fibre

**Minimum bending radius**  
(indoor) 120 mm  
(outdoor) 200 mm

**Optical values**  
Attenuation at 850 nm wavelength: 8 dB/km  
Bandwidth-length product: 20 MHz x km at 850 nm  
Numerical aperture: 0.37

**Temperature range**  
Occasional flexing: -30°C to +70°C  
Fixed installation: -40°C to +70°C

**Permissible tensile force**  
Fixed installation (indoor): 400 N  
Fixed installation (outdoor): 500 N

Article number	Article designation	Fibre type	Number of fibres	Outer diameter (mm)	Weight (kg/km)
2185311	HITRONIC® BUS PCF PUR DUPLEX indoor	PCF	2	8.0	55
2185302	HITRONIC® BUS PCF PE DUPLEX outdoor	PCF	2	10.5	90

Unless specified otherwise, the shown product values are nominal values. Detailed values (e.g. tolerances) are available upon request.  
Mille-Tie™ is a registered trademark of Millepede™ International Ltd.  
Photographs are not to scale and do not represent detailed images of the respective products.

**Accessories**

- SMARTSTRIP stripping tool refer to main catalogue 2012 page 907
- DATA STRIP stripping tool refer to main catalogue 2012 page 907
- Mille-Tie™ cable ties refer to main catalogue 2012 page 961
- Damage-free cable bundles through: Mille-Tie™

# HITRONIC® HQN Outdoor Cable



**Info**

- A-DQ(ZN)B2Y
- Outdoor cable with central loose tube and non-metallic strain relief

**Benefits**

- Suitable for direct burial
- Easy to install due to the compact design, high flexibility, robust sheath and small bending radii
- UV and water-resistant
- Zero electromagnetic interference as the cable contains no metal

**Application range**

- For outdoor use
- Windpark installation
- Industrial environment
- Methods of Deployment: empty plastic pipes, ducts and trays

**Product features**

- Central loose tube with up to 24 fibres
- Colour-coded fibres
- Longitudinal watertight
- Rodent-protection
- Robust, halogen-free outer sheath

**Approvals**



**Design**

- Glass fibres with primary coating
- Gel-filled loose tube
- Water-blocking reinforced glass yarn strength members
- PE outer sheath
- Colour: black (RAL 9005)

**Technical data**



**Optical fibre type**  
Core material: Glass  
Cladding material: Glass



**Temperature range**  
Occasional flexing: -30°C to +70°C  
Fixed installation: -40°C to +70°C



**Permissible bending radius**  
Static: ≥ 15 x outer diameter  
Dynamic: ≥ 20 x outer diameter



**Permissible tensile force**  
Fixed installation: 1500 N  
Short-term: 3000 N

Article number	Article designation	Fibre type	Number of fibres	Outer diameter (mm)
<b>Multimode G 50 OM3</b>				
27600304	HITRONIC® HQN 1500 4G 50/125 OM3	50/125 OM3	4	7.3
27600308	HITRONIC® HQN 1500 8G 50/125 OM3	50/125 OM3	8	7.3
27600312	HITRONIC® HQN 1500 12G 50/125 OM3	50/125 OM3	12	7.3
27600324	HITRONIC® HQN 1500 24G 50/125 OM3	50/125 OM3	24	8.3
<b>Multimode G 50 OM2</b>				
27600204	HITRONIC® HQN 1500 4G 50/125 OM2	50/125 OM2	4	7.3
27600208	HITRONIC® HQN 1500 8G 50/125 OM2	50/125 OM2	8	7.3
27600212	HITRONIC® HQN 1500 12G 50/125 OM2	50/125 OM2	12	7.3
27600224	HITRONIC® HQN 1500 24G 50/125 OM2	50/125 OM2	24	8.3
<b>Multimode G 62.5 OM1</b>				
27600104	HITRONIC® HQN 1500 4G 62.5/125 OM1	62.5/125 OM1	4	7.3
27600108	HITRONIC® HQN 1500 8G 62.5/125 OM1	62.5/125 OM1	8	7.3
27600112	HITRONIC® HQN 1500 12G 62.5/125 OM1	62.5/125 OM1	12	7.3
27600124	HITRONIC® HQN 1500 24G 62.5/125 OM1	62.5/125 OM1	24	8.3
<b>Single-mode E 9 OS2</b>				
27600904	HITRONIC® HQN 1500 4E 9/125 OS2	9/125 OS2	4	7.3
27600908	HITRONIC® HQN 1500 8E 9/125 OS2	9/125 OS2	8	7.3
27600912	HITRONIC® HQN 1500 12E 9/125 OS2	9/125 OS2	12	7.3
27600924	HITRONIC® HQN 1500 24E 9/125 OS2	9/125 OS2	24	8.3

Unless specified otherwise, the shown product values are nominal values. Detailed values (e.g. tolerances) are available upon request. The cables can also be supplied as pre-terminated fibre optic trunks. Photographs are not to scale and do not represent detailed images of the respective products.

**Accessories**

- Simplex Pigtail refer to page 93
- DATA STRIP stripping tool refer to main catalogue 2012 page 907

ÖLFLEX®  
UNITRONIC®  
ETHERLINE®  
HITRONIC®  
EPIC®  
SKINTOP®  
SILVYN®  
FLEXIMARK®  
ACCESSORIES

**New**

# HITRONIC® HVN Outdoor Cable



**Info**

- A-DQ(ZN)B2Y
- Outdoor cable with stranded loose tube and non-metallic strain relief

**Benefits**

- Suitable for direct burial
- Easy to install due to the compact design, high flexibility, robust sheath and small bending radii
- UV and water-resistant
- Zero electromagnetic interference as the cable contains no metal

**Application range**

- For outdoor use
- Windpark installation
- Industrial environment
- Methods of Deployment: empty plastic pipes, ducts and trays

**Product features**

- Stranded loose tube with up to 144 fibres (12 loose tubes with each 12 fibres)
- Colour-coded fibres and loose tubes
- Longitudinal watertight
- Rodent-protection
- Robust, halogen-free outer sheath

**Approvals**



**Design**

- Up to 12 stranded gel-filled loose tubes
- Central GRP strength member
- Water-blocking reinforced glass yarn strength members
- PE outer sheath
- Colour: black (RAL 9005)

**Technical data**

- Optical fibre type**  
Core material: Glass  
Cladding material: Glass
- Temperature range**  
Occasional flexing: -30°C to +70°C  
Fixed installation: -40°C to +70°C
- Permissible bending radius**  
Static: ≥ 15 x outer diameter  
Dynamic: ≥ 20 x outer diameter
- Permissible tensile force**  
Fixed installation: 5000 N  
Short-term: 6000 N

Article number	Article designation	Fibre type	Number of fibres	Outer diameter (mm)
<b>Multimode G 50 OM3</b>				
26600324	HITRONIC® HVN5000 2x12G 50/125 OM3	50/125 OM3	24	11
26600348	HITRONIC® HVN5000 4x12G 50/125 OM3	50/125 OM3	48	11
<b>Single-mode E 9 OS2</b>				
26600924	HITRONIC® HVN5000 2x12 E 9/125 OS2	9/125 OS2	24	11
26600948	HITRONIC® HVN5000 4x12 E 9/125 OS2	9/125 OS2	48	11

Unless specified otherwise, the shown product values are nominal values. Detailed values (e.g. tolerances) are available upon request.  
 The cables can also be supplied as pre-terminated fibre optic trunks.  
 Photographs are not to scale and do not represent detailed images of the respective products.  
 Other models are available upon request.

ÖLFLEX®

UNITRONIC®

ETHERLINE®

HITRONIC®

EPIC®

SKINTOP®

SILVYN®

FLEXIMARK®

ACCESSORIES

## Duplex Jumper/Patchcord



**Info**

- J-VH 2x1 G/E
- Pre-terminated tight buffered duplex cable with durable ceramic ferrules

**Benefits**

- “Plug & Play” connection between any optical devices
- Non-permanent connections allow for easy change of equipment
- Direct connection between two active optical components
- Zero electromagnetic interference as the cable contains no metal

**Application range**

- For indoor use
- Inside Top/Bottom box

**Product features**

- Flame-retardant and halogen-free
- High flexibility
- Cable termination with durable ceramic ferrules

**Approvals**



**Design**

- Tight-buffered duplex cable with FRNC outer sheath
- Connector: LC, SC or ST
- Cable colour: aqua for multimode OM3, orange for multimode OM2 and OM1, yellow for single-mode OS2
- Standard length: 2 m

**Technical data**

- Optical fibre type**  
Core material: Glass  
Cladding material: Glass
- Temperature range**  
Occasional flexing: -5°C to +50°C  
Fixed installation: -20°C to +60°C
- Permissible bending radius**  
Static: ≥ 30 mm  
Dynamic: ≥ 40 mm
- Permissible tensile force**  
Fixed installation: 150 N

Article number	Article designation	PU
<b>Duplex Jumper Singlemode 9 µm</b>		
94841	Duplex Jumper ST/ST 9 µm, 2 m	1 piece
94891	Duplex Jumper SC/SC 9 µm, 2 m	1 piece
94931	Duplex Jumper ST/SC 9 µm, 2m	1 piece
9498	Duplex Jumper LSH APC/LC 9 µm, 2 m	1 piece
9477	Duplex Jumper LSH APC/LSH APC 9 µm, 2m	1 piece
9495	Duplex Jumper LSH APC/SC 9 µm, 2 m	1 piece
<b>Duplex Jumper Multimode 50 µm</b>		
93681	Duplex Jumper ST/ST 50 µm, 2 m	1 piece
93561	Duplex Jumper SC/SC 50 µm, 2 m	1 piece
94641	Duplex Jumper ST/SC 50 µm, 2 m	1 piece
9510	Duplex Jumper MTRJ/MTRJ 50 µm, 2m	1 piece
9513	Duplex Jumper MTRJ/ST 50 µm, 2 m	1 piece
9509	Duplex Jumper LC/LC 50 µm, 2 m	1 piece
9508	Duplex Jumper LC/SC 50 µm, 2 m	1 piece
9501	Duplex Jumper LC/ST 50 µm, 2 m	1 piece
9457	Duplex Jumper LSH/LSH 50 µm, 2 m	1 piece
9511	Duplex Jumper MTRJ/SC 50 µm, 2 m	1 piece
<b>Duplex Jumper Multimode 62.5 µm</b>		
93781	Duplex Jumper ST/ST 62.5 µm, 2 m	1 piece
93581	Duplex Jumper SC/SC 62.5 µm, 2m	1 piece
94651	Duplex Jumper ST/SC 62.5 µm, 2 m	1 piece
9519	Duplex Jumper LC/LC 62.5 µm, 2 m	1 piece
9531	Jumper Duplex LC/ST 62.5 µm, 2 m	1 piece
9521	Duplex Jumper MTRJ/SC 62.5 µm, 2 m	1 piece
9528	Duplex Jumper LC/SC 62.5 µm, 2 m	1 piece
9523	Duplex Jumper MTRJ/ST 62.5 µm, 2 m	1 piece

Other lengths and types of connectors are available upon request.  
Photographs are not to scale and do not represent detailed images of the respective products.

ÖLFLEX® | UNITRONIC® | ETHERLINE® | HITRONIC® | EPIC® | SKINTOP® | SILVYN® | FLEXIMARK® | ACCESSORIES

# Simplex Pigtail

**Info**

- J-VH 1 G/E
- Pre-terminated tight-buffered simplex cable with one durable ceramic ferrule



**Benefits**

- Create a direct plug connection for installation cables with splicing
- Ease of installation and assembly
- Zero electromagnetic interference as the cable contains no metal

**Application range**

- For indoor use
- Inside Top/Bottom box

**Product features**

- Flame-retardant and halogen-free
- High flexibility
- Cable termination with durable ceramic ferrules
- Set consisting of 12 colour-coded pigtails

**Approvals**



**Design**

- Tight-buffered simplex fibre with FRNC secondary coating (900 µm)
- Connector: LC, SC or ST
- Colour-coded primary and secondary coatings
- Standard length: 2 m

**Technical data**

**Optical fibre type**  
Core material: Glass  
Cladding material: Glass

**Temperature range**  
Occasional flexing: -5°C to +50°C  
Fixed installation: -20°C to +60°C

**Permissible tensile force**  
Fixed installation: 150 N

Article number	Article designation	PU
<b>Pigtail Multimode 50 µm</b>		
93911	ST Pigtail Simplex 50 µm, 2m	12 piece
93411	SC Pigtail 50 µm, 2 m	12 piece
<b>Pigtail Multimode 62.5 µm</b>		
93931	ST Pigtail Simplex 62.5 µm, 2 m	12 piece
93441	SC Pigtail Simplex 62.5 µm, 2 m	12 piece
<b>Pigtail Singlemode 9 µm</b>		
93471	ST Pigtail Simplex 9 µm, 2 m	12 piece
93401	SC Pigtail Simplex 9 µm, 2 m	12 piece
9396	LSH APC Pigtail Simplex 9 µm, 2 m	12 piece

Other types of connectors (e.g. LC, MTRJ, E2000) are available upon request. Judy Lim: This will not apply to Hitronic anymore, as LC will become a standard product and MTRJ/E2000 will be removed. Photographs are not to scale and do not represent detailed images of the respective products.



## EPIC® H-A 3 Kits Metal



Article number	Pieces / PU
75009602	1

**Article numbers for single components**

- H-A 3 SS 10420000
- H-A 3 MTgv M20 19512100

**EPIC KIT H-A 3 SS MTG M20**



- EPIC® H-A 3 screw-termination male insert
- EPIC® H-A 3 hood
- Housing: zinc die-casting, grey



Article number	Pieces / PU
75009604	1

**Article numbers for single components**

- H-A 3 SS 10420000
- H-A 3 Ts M20 19512300

**EPIC KIT H-A 3 SS MTS M20**



- EPIC® H-A 3 screw-termination male insert
- EPIC® H-A 3 hood
- Side cable entry
- Housing: zinc die-casting, grey

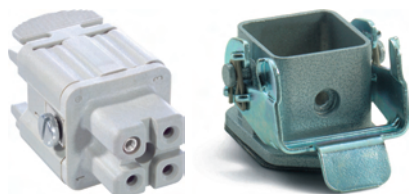

Article number	Pieces / PU
75009606	1

**Article numbers for single components**

- H-A 3 BS 10421000
- H-A 3 Mag 10422500

**EPIC KIT H-A 3 BS MAG**



- EPIC® H-A 3 screw termination female insert
- EPIC® H-A 3 panel-mount base
- Straight version
- Housing: zinc die-casting, grey

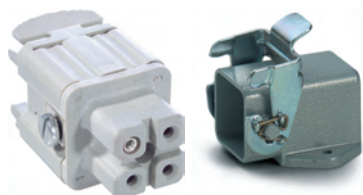

Article number	Pieces / PU
75009608	1

**Article numbers for single components**

- H-A 3 BS 10421000
- H-A 3 Mags 10423500

**EPIC KIT H-A 3 BS MAGS**



- EPIC® H-A 3 screw termination female insert
- EPIC® H-A 3 panel-mount base
- Angled version
- Housing: zinc die-casting, grey

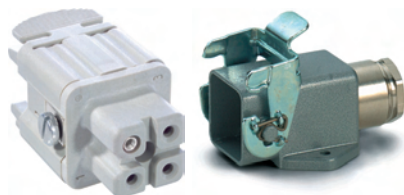

Article number	Pieces / PU
75009610	1

**Article numbers for single components**

- H-A 3 BS 10421000
- H-A 3 MAgsv M20 19512700

**EPIC KIT H-A 3 BS MAGS M20**



- EPIC® H-A 3 screw termination female insert
- EPIC® H-A 3 panel-mount base
- Angled version
- Housing: zinc die-casting, grey



Article number	Pieces / PU
75009612	1

**Article numbers for single components**

- H-A 3 BS 10421000
- H-A 3 MTgvb M20 19512900

**EPIC KIT H-A 3 BS MTGB M20**



- EPIC® H-A 3 screw termination female insert
- EPIC® H-A 3 cable coupler hood
- Housing: zinc die-casting, grey



**Info**

- Complete connectors - easy to order
- For more products see main catalogue 2012

**Benefits**

- Pre-packed kits with compatible components
- Uncomplicated ordering
- No misplaced orders

**Similar products**

- EPIC® H-A 3 Kits Thermoplastic refer to main catalogue 2012 page 583

**Technical data**

**Rated voltage (V)**

- IEC: 400 V
- UL: 600 V
- CSA: 600 V

**Rated current (A)**

- IEC: 23 A
- UL: 10 A
- CSA: 10 A

**Number of contacts**

3 + PE

ÖLFLEX®  
 UNITRONIC®  
 ETHERLINE®  
 HITRONIC®  
 EPIC®  
 SKINTOP®  
 SILVYN®  
 FLEXIMARK®  
 ACCESSORIES

**EPIC® H-BE 16 Kits**

**EPIC® KIT H-BE 16 SS TG M25**



- EPIC® H-BE 16 screw termination female insert
- With wire protection
- EPIC® H-B 16 hood

Article number	Pieces / PU
75009645	1

**Article numbers for single components**

- H-BE 16 SS 10194000
- H-B 16 TG M25 19080000

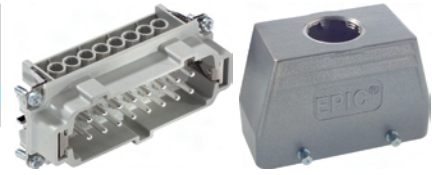

**EPIC® KIT H-BE 16 SS TS M25**



- EPIC® H-BE 16 screw termination female insert
- With wire protection
- EPIC® H-B 16 hood

Article number	Pieces / PU
75009646	1

**Article numbers for single components**

- H-BE 16 SS 10194000
- H-B 16 TS M25 19082000

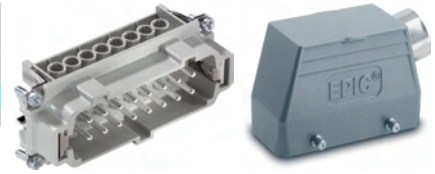

**EPIC® KIT H-BE 16 BS AG**



- EPIC® H-BE 16 screw termination female insert
- With wire protection
- EPIC® H-B 16 panel-mount base

Article number	Pieces / PU
75009647	1

**Article numbers for single components**

- H-BE 16 BS 10195000
- H-B 16 AG 10072000

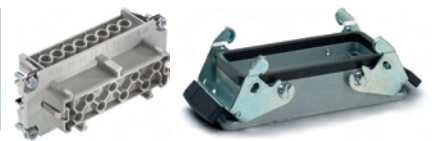

**EPIC® KIT H-BE 16 BS SGR M25**



- EPIC® H-BE 16 screw termination female insert
- With wire protection
- EPIC® H-B 16 surface-mount base

Article number	Pieces / PU
75009648	1

**Article numbers for single components**

- H-BE 16 BS 10195000
- H-B 16 SGR M25 19074000



**EPIC® KIT H-BE 16 BS TBF M25**



- EPIC® H-BE 16 screw termination female insert
- With wire protection
- EPIC® H-B 16 cable coupler hood

Article number	Pieces / PU
75009649	1

**Article numbers for single components**

- H-BE 16 BS 10195000
- H-B 16 TBF M25 19086000

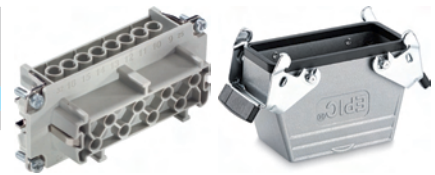

**Info**

- Complete connectors - easy to order
- For more products see main catalogue 2012

**Benefits**

- Pre-packed kits with compatible components
- Uncomplicated ordering
- No misplaced orders

**Technical data**

**Rated voltage (V)**  
IEC: 500 V  
UL: 600 V  
CSA: 600 V

**Rated current (A)**  
IEC: 16 A  
UL: 16 A  
CSA: 16 A

**Number of contacts**  
16 + PE



**On request:**  
plastic moulded connector,  
according to customer specification.

**New**

**SKINTOP® STR-M / SKINTOP® ST-M**

**Info**

- Now with IP 69 K approval! Proven to withstand the most demanding cleaning procedures for industrial machinery with high-pressure cleaners and hot water!



**Benefits**

**SKINTOP® ST-M**

- High oil-resistance for maximum reliability
- Permanent vibration protection
- Wide, variable clamping ranges
- Optimum strain relief
- Various accessories (e.g. multiple sealing inserts)

**SKINTOP® STR-M**

- For the benefits, refer to SKINTOP® ST-M

**Application range**

**SKINTOP® ST-M**

- Used in areas where cables and wires need to be safely inserted into housings
- Machine and equipment manufacturing
- Automation technology
- Offshore platforms, equipment and shipyards

**SKINTOP® STR-M**

- With reducing seal insert, to seal cables with smaller outer diameters.

**Approvals**



- UL File Nr. E79903

**Design**

- Metric connection thread acc. to EN 50262

**Note**

**SKINTOP® ST-M**

- Refer to SKINTOP® metric accessories for suitable accessories
- Counter nut to be used: SKINTOP® GMP-GL-M
- SKINTOP® ST M ISO types have an extra-long connection thread
- SKINTOP® ST M ISO versions with extra-long connection thread, see table, no DNV approval
- SKINTOP® BRUSH ADD-ON can be used for EMC solution

**SKINTOP® STR-M**

- Refer to SKINTOP® metric accessories for suitable accessories
- Counter nut to be used: SKINTOP® GMP-GL-M
- SKINTOP® STR M ISO types have an extra-long connection thread
- SKINTOP® STR M ISO versions with extra-long connection thread, see table, no DNV approval
- SKINTOP® BRUSH ADD-ON can be used for EMC solution

**Technical data**

**Caution**  
Refer to Appendix T21 for the installation dimensions and torques

**Colour delivered**  
Silver grey (RAL 7001)  
Light grey (RAL 7035)  
Black (RAL 9005), UV-resistant

**Material**  
Body: Polyamide  
Seal: CR

**Tests**  
GGVS: TÜ.EGG.020-95

**Protection rating**  
IP 68 - 5 bar  
IP 69 K

**Temperature range**  
Dynamic: -20°C to +100°C  
Static: -40°C to +100°C

**Suitable cables**

- The following cables are recommended for IP 69 K applications:  
ÖLFLEX® ROBUST 200  
H07RN8-F  
H07RN-F

**Suitable tools**

**SKINTOP® ST-M**

- SKINMATIC® QUICK Set 1 refer to main catalogue 2012 page 710
- SKINMATIC® RZ refer to main catalogue 2012 page 711
- SKINMATIC® MH Set refer to main catalogue 2012 page 710

Article number	Article designation / size	Clamping range ØF (mm)	SW (mm)	Overall length, C (mm)	Thread length inner mm	Pieces / PU
<b>SKINTOP® ST-M silver grey</b>						
53111000	ST-M 12 x 1,5	3,5-7	15	30,0	8,0	100
53111010	ST-M 16 x 1,5	4,5-10	19	34,0	8,0	100
53111020	ST-M 20 x 1,5	7-13	25	37,0	9,0	100
53111030	ST-M 25 x 1,5	9-17	30	40,0	10,0	50
53111040	ST-M 32 x 1,5	11-21	36	47,0	10,0	25
53111050	ST-M 40 x 1,5	19-28	46	52,0	10,0	10
53111060	ST-M 50 x 1,5	27-35	55	62,0	12,0	5
53111070	ST-M 63 x 1,5	34-45	66	71,0	12,0	5
<b>SKINTOP® ST-M black</b>						
53111200	ST-M 12 x 1,5	3,5-7	15	30,0	8,0	100
53111210	ST-M 16 x 1,5	4,5-10	19	34,0	8,0	100
53111220	ST-M 20 x 1,5	7-13	25	37,0	9,0	100
53111230	ST-M 25 x 1,5	9-17	30	40,0	10,0	50
53111240	ST-M 32 x 1,5	11-21	36	47,0	10,0	25
53111250	ST-M 40 x 1,5	19-28	46	52,0	10,0	10
53111260	ST-M 50 x 1,5	27-35	55	62,0	12,0	5
53111270	ST-M 63 x 1,5	34-45	66	71,0	12,0	5
<b>SKINTOP® ST-M light grey</b>						
53111400	ST-M 12 x 1,5	3,5-7	15	30,0	8,0	100
53111410	ST-M 16 x 1,5	4,5-10	19	34,0	8,0	100
53111420	ST-M 20 x 1,5	7-13	25	37,0	9,0	100
53111430	ST-M 25 x 1,5	9-17	30	40,0	10,0	50
53111440	ST-M 32 x 1,5	11-21	36	47,0	10,0	25
53111450	ST-M 40 x 1,5	19-28	46	52,0	10,0	10
53111460	ST-M 50 x 1,5	27-35	55	62,0	12,0	5
53111470	ST-M 63 x 1,5	34-45	66	71,0	12,0	5

## SKINTOP® metric plastic cable glands

Easy to install

Article number	Article designation / size	Clamping range ØF (mm)	SW (mm)	Overall length, C (mm)	Thread length inner mm	Pieces / PU
<b>SKINTOP® ST M ISO silver-grey (with long metric connecting thread)</b>						
53017010	ST M 16 x 1,5	3,5-8	19	40,0	12,0	100
53017030	ST M 20 x 1,5	5-12	24	45,0	13,0	100
53017040	ST M 25 x 1,5	9-14	27	47,0	13,0	50
<b>SKINTOP® ST M ISO black (with long metric connecting thread)</b>						
53017210	ST M 16 x 1,5	3,5-8	19	40,0	12,0	100
53017230	ST M 20 x 1,5	5-12	24	45,0	13,0	100
53017240	ST M 25 x 1,5	9-14	27	47,0	13,0	50
<b>SKINTOP® STR-M silver grey</b>						
53111100	STR-M 12 x 1,5	1-5	15	30,0	8,0	100
53111110	STR-M 16 x 1,5	2-7	19	34,0	8,0	100
53111120	STR-M 20 x 1,5	5-10	25	37,0	9,0	100
53111130	STR-M 25 x 1,5	6-13	30	40,0	10,0	50
53111140	STR-M 32 x 1,5	7-15	36	47,0	10,0	25
53111150	STR-M 40 x 1,5	15-23	46	52,0	10,0	10
53111160	STR-M 50 x 1,5	22-29	55	62,0	12,0	5
53111170	STR-M 63 x 1,5	28-39	66	71,0	12,0	5
<b>SKINTOP® STR-M black</b>						
53111300	STR-M 12 x 1,5	1-5	15	30,0	8,0	100
53111310	STR-M 16 x 1,5	2-7	19	34,0	8,0	100
53111320	STR-M 20 x 1,5	5-10	25	37,0	9,0	100
53111330	STR-M 25 x 1,5	6-13	30	40,0	10,0	50
53111340	STR-M 32 x 1,5	7-15	36	47,0	10,0	25
53111350	STR-M 40 x 1,5	15-23	46	52,0	10,0	10
53111360	STR-M 50 x 1,5	22-29	55	62,0	12,0	5
53111370	STR-M 63 x 1,5	28-39	66	71,0	12,0	5
<b>SKINTOP® STR-M light grey</b>						
53111500	STR-M 12 x 1,5	1-5	15	30,0	8,0	100
53111510	STR-M 16 x 1,5	2-7	19	34,0	8,0	100
53111520	STR-M 20 x 1,5	5-10	25	37,0	9,0	100
53111530	STR-M 25 x 1,5	6-13	30	40,0	10,0	50
53111540	STR-M 32 x 1,5	7-15	36	47,0	10,0	25
53111550	STR-M 40 x 1,5	15-23	46	52,0	10,0	10
53111560	STR-M 50 x 1,5	22-29	55	62,0	12,0	5
53111570	STR-M 63 x 1,5	28-39	66	71,0	12,0	5
<b>SKINTOP® STR M ISO silver-grey (with long metric connecting thread)</b>						
53017110	STR M 16 x 1,5	2-6	19	40,0	12,0	100
53017130	STR M 20 x 1,5	4-9	24	45,0	13,0	100
53017140	STR M 25 x 1,5	6-12	27	47,0	13,0	50
<b>SKINTOP® STR M ISO black (with long metric connecting thread)</b>						
53017310	STR M 16 x 1,5	2-6	19	40,0	12,0	100
53017330	STR M 20 x 1,5	4-9	24	45,0	13,0	100
53017340	STR M 25 x 1,5	6-12	27	47,0	13,0	50

Photographs are not to scale and do not represent detailed images of the respective products.

#### ■ Accessories

##### SKINTOP® ST-M

- SKINTOP® BRUSH ADD-ON refer to page 106
- SKINTOP® DIX-M refer to page 108
- SKINTOP® GMP-GL-M refer to page 107
- SKINTOP® DIX-M AUTOMATION refer to page 109
- SKINTOP® SDV-M ATEX refer to main catalogue 2012 page 674
- SKINTOP® SD-M refer to main catalogue 2012 page 675
- SKINTOP® DV-M refer to main catalogue 2012 page 675

##### SKINTOP® STR-M

- SKINTOP® BRUSH ADD-ON refer to page 106
- SKINTOP® GMP-GL-M refer to page 107
- SKINTOP® SDVR-M ATEX refer to main catalogue 2012 page 674
- SKINTOP® SD-M refer to main catalogue 2012 page 675

**New**

**SKINTOP® CLICK-R / SKINTOP® CLICK**

**Info**

- The most innovative cable insertion system in the market for a fast and highly flexible assembly. Simply click in - turn to the left - turn to the right - finished. The result: fixed, centred, strain-relieved fitting and maximum protection class in a few seconds.

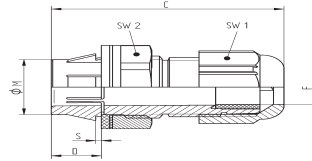

SKINTOP® CLICK

**Benefits**

**SKINTOP® CLICK**

- Fewer parts, counter nut no longer needed
- Save up to 70% of the time with the innovative CLICK system
- Simple, free assembly in any position
- Vibration protection
- No thread required

**SKINTOP® CLICK-R**

- For the benefits, refer to SKINTOP® CLICK

**Application range**

**SKINTOP® CLICK**

- Automation technology
- Wind applications
- Control cabinet manufacturing
- Measurement, control and electrical applications
- Air-conditioning technology

**SKINTOP® CLICK-R**

- With reducing seal insert, to seal cables with smaller outer diameters.

**Approvals**



- UL File Nr. E79903

**Included**

- Included: disassembly tool

**Technical data**

**Colour delivered**  
 Silver grey (RAL 7001)  
 Light grey (RAL 7035)  
 Black (RAL 9005), UV-resistant

**Material**  
 Body: special polyamide  
 Seal: special elastomer

**Protection rating**  
**SKINTOP® CLICK**  
 IP 68 - 4 bar (M12)  
 IP 68 - 5 bar (M16 - M32)

**Temperature range**  
 Dynamic: -20°C to +100°C  
 Static: -40°C to +100°C

Article number	Article designation / size	Clamping range ØF (mm)	M (hole in mm)	SW1/SW2 mm	Overall length, C (mm)	Thread length inner mm	Wall thickness, S (mm)	Pieces / PU
<b>SKINTOP® CLICK light grey</b>								
53112692	CLICK 12	3.5 - 7	12.3 (-0.2)	15 / 18	40.0	8.0	1.0 - 4.0	50
53112686	CLICK 16	5 - 9	16.3 (-0.2)	19 / 22	42.0	8.0	1.0 - 4.0	50
53112687	CLICK 20	7 - 13	20.3 (-0.2)	25 / 27	45.5	8.0	1.0 - 4.0	25
53112688	CLICK 25	9 - 17	25.3 (-0.2)	30 / 34	48.5	8.0	1.0 - 4.0	25
53112694	CLICK 32	11 - 21	32.3 (-0.2)	36 / 40	55.0	8.0	1.0 - 4.0	25
<b>SKINTOP® CLICK silver grey</b>								
53112921	CLICK 12	3.5 - 7	12.3 (-0.2)	15 / 18	40.0	8.0	1.0 - 4.0	50
53112876	CLICK 16	5 - 9	16.3 (-0.2)	19 / 22	42.0	8.0	1.0 - 4.0	50
53112877	CLICK 20	7 - 13	20.3 (-0.2)	25 / 27	45.5	8.0	1.0 - 4.0	25
53112878	CLICK 25	9 - 17	25.3 (-0.2)	30 / 34	48.5	8.0	1.0 - 4.0	25
53112922	CLICK 32	11 - 21	32.3 (-0.2)	36 / 40	55.0	8.0	1.0 - 4.0	25
<b>SKINTOP® CLICK black</b>								
53112923	CLICK 12	3.5 - 7	12.3 (-0.2)	15 / 18	40.0	8.0	1.0 - 4.0	50
53112882	CLICK 16	5 - 9	16.3 (-0.2)	19 / 22	42.0	8.0	1.0 - 4.0	50
53112883	CLICK 20	7 - 13	20.3 (-0.2)	25 / 27	45.5	8.0	1.0 - 4.0	25
53112884	CLICK 25	9 - 17	25.3 (-0.2)	30 / 34	48.5	8.0	1.0 - 4.0	25
53112924	CLICK 32	11 - 21	32.3 (-0.2)	36 / 40	55.0	8.0	1.0 - 4.0	25
<b>SKINTOP® CLICK-R light grey</b>								
53112925	CLICK-R 12	1 - 5	12.3 (-0.2)	15 / 18	40.0	8.0	1.0 - 4.0	50
53112689	CLICK-R 16	4 - 7	16.3 (-0.2)	19 / 22	42.0	8.0	1.0 - 4.0	50
53112690	CLICK-R 20	5 - 10	20.3 (-0.2)	25 / 27	45.5	8.0	1.0 - 4.0	25
53112691	CLICK-R 25	6 - 13	25.3 (-0.2)	30 / 34	48.5	8.0	1.0 - 4.0	25
53112926	CLICK-R 32	7 - 15	32.3 (-0.2)	36 / 40	55.0	8.0	1.0 - 4.0	25
<b>SKINTOP® CLICK-R silver grey</b>								
53112927	CLICK-R 12	1 - 5	12.3 (-0.2)	15 / 18	40.0	8.0	1.0 - 4.0	50
53112879	CLICK-R 16	4 - 7	16.3 (-0.2)	19 / 22	42.0	8.0	1.0 - 4.0	50
53112880	CLICK-R 20	5 - 10	20.3 (-0.2)	25 / 27	45.5	8.0	1.0 - 4.0	25
53112881	CLICK-R 25	6 - 13	25.3 (-0.2)	30 / 34	48.5	8.0	1.0 - 4.0	25
53112928	CLICK-R 32	7 - 15	32.3 (-0.2)	36 / 40	55.0	8.0	1.0 - 4.0	25
<b>SKINTOP® CLICK-R black</b>								
53112929	CLICK-R 12	1 - 5	12.3 (-0.2)	15 / 18	40.0	8.0	1.0 - 4.0	50
53112885	CLICK-R 16	4 - 7	16.3 (-0.2)	19 / 22	42.0	8.0	1.0 - 4.0	50
53112886	CLICK-R 20	5 - 10	20.3 (-0.2)	25 / 27	45.5	8.0	1.0 - 4.0	25
53112887	CLICK-R 25	6 - 13	25.3 (-0.2)	30 / 34	48.5	8.0	1.0 - 4.0	25
53112931	CLICK-R 32	7 - 15	32.3 (-0.2)	36 / 40	55.0	8.0	1.0 - 4.0	25

Photographs are not to scale and do not represent detailed images of the respective products.

**Accessories**

**SKINTOP® CLICK**

- SKINTOP® DIX-M refer to page 108
- SKINTOP® DIX-M AUTOMATION refer to page 109
- SKINTOP® SDV-M ATEX refer to main catalogue 2012 page 674
- SKINTOP® SD-M refer to main catalogue 2012 page 675
- SKINTOP® DV-M refer to main catalogue 2012 page 675

**SKINTOP® CLICK-R**

- SKINTOP® SDVR-M ATEX refer to main catalogue 2012 page 674

# SKINTOP® BS-M



SKINTOP® BS-M

**Benefits**

- Reliable bending and anti-kink protection
- Cable conservation
- Functional reliability
- To protect flexible cables

**Application range**

- Cables for electrical appliances and machinery that are moved under normal use must be protected against excessive bending as required in accordance with VDE 0730.
- Handheld device
- Moving machine parts
- Fan`s / Ventilation

**Approvals**



- UL File Nr. E79903

**Design**

- Metric connection thread acc. to EN 50262

**Note**

- Refer to SKINTOP® metric accessories for suitable accessories
- Counter nut to be used: SKINTOP® GMP-GL-M
- Version with reducing insert to seal smaller cable cross-sections SKINTOP® BSR-M on request
- SKINTOP® BS M ISO versions with extra-long connection thread, see table, no DNV approval

**Technical data**

- Caution**  
Refer to Appendix T21 for the installation dimensions and torques
- On request**  
with reducing sealing ring
- Colour delivered**  
Silver grey (RAL 7001)  
Light grey (RAL 7035)  
Black (RAL 9005), UV-resistant
- Material**  
Body: Polyamide  
Seal: CR
- Protection rating**  
IP 68 - 5 bar  
IP 69 K pending
- Temperature range**  
Dynamic: -20°C to +100°C  
Static: -40°C to +100°C

Article number	Article designation / size	Clamping range ØF (mm)	SW (mm)	Overall length, C (mm)	Thread length inner mm	Pieces / PU
<b>SKINTOP® BS-M silver grey</b>						
53111600	BS-M 12x1,5	3,5-7	15	64,0	8,0	100
53111610	BS-M 16x1,5	4,5-10	19	86,0	8,0	100
53111620	BS-M 20x1,5	7-13	25	101,0	8,0	50
53111630	BS-M 25x1,5	9-17	30	125,0	9,0	25
53111640	BS-M 32x1,5	11-21	36	149,0	10,0	25
<b>SKINTOP® BS-M black</b>						
53111700	BS-M 12x1,5	3,5-7	15	64,0	8,0	100
53111710	BS-M 16x1,5	4,5-10	19	86,0	8,0	100
53111720	BS-M 20x1,5	7-13	25	101,0	8,0	50
53111730	BS-M 25x1,5	9-17	30	125,0	9,0	25
53111740	BS-M 32x1,5	11-21	36	149,0	10,0	25
<b>SKINTOP® BS-M light grey</b>						
53111800	BS-M 12x1,5	3,5-7	15	64,0	8,0	100
53111810	BS-M 16x1,5	4,5-10	19	86,0	8,0	100
53111820	BS-M 20x1,5	7-13	25	101,0	8,0	50
53111830	BS-M 25x1,5	9-17	30	125,0	9,0	25
53111840	BS-M 32x1,5	11-21	36	149,0	10,0	25
<b>SKINTOP® BS M ISO silver-grey (with long metric connecting thread)</b>						
53017610	BS M16 x 1,5 PG 9	3,5-8	19	77,5	12,0	100
53017630	BS M 20 x 1,5 PG 13,5	5-12	24	102,0	13,0	50
53017640	BS M 25 x 1,5 PG 16	9-14	27	114,5	13,0	50
<b>SKINTOP® BS M ISO black (with long metric connecting thread)</b>						
53017810	BS M 16 x 1,5 PG 9	3,5-8	19	77,5	12,0	100
53017830	BS M 20 x 1,5 PG 13,5	5-12	24	102,0	13,0	50
53017840	BS M 25 x 1,5 PG 16	9-14	27	114,5	13,0	50

Photographs are not to scale and do not represent detailed images of the respective products.

**SKINTOP® BT-M**

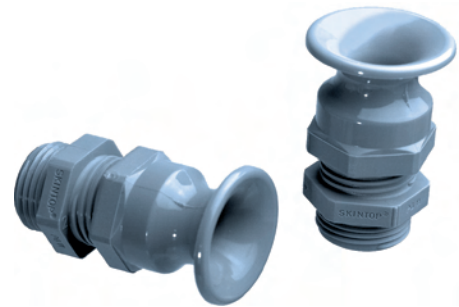
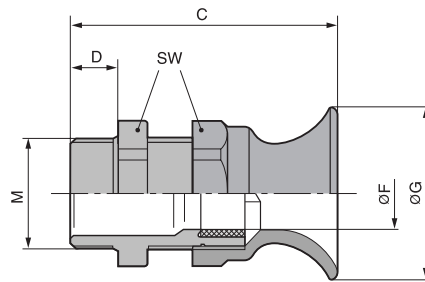

SKINTOP® BT-M

**Benefits**

- Reliable bending and anti-kink protection
- Cable conservation
- Functional reliability
- To protect flexible cables

**Application range**

- Cables for electrical appliances and machinery that are moved under normal use must be protected against excessive bending as required in accordance with VDE 0730.
- Handheld device
- Moving machine parts

**Approvals**



**Design**

- Metric connection thread acc. to EN 50262

**Note**

- Refer to SKINTOP® PG accessories for suitable accessories
- Counter nut to be used: SKINTOP® GMP-GL-M

**Technical data**

- Caution**  
Refer to Appendix T21 for the installation dimensions and torques
- Colour delivered**  
Silver grey (RAL 7001)
- Material**  
Body: Polyamide  
Seal: CR
- Protection rating**  
IP 68 - 5 bar
- Temperature range**  
Dynamic: -20°C to +100°C  
Static: -40°C to +100°C

Article number	Article designation / size	Clamping range ØF (mm)	SW (mm)	Overall length, C (mm)	Thread length inner mm	Pieces / PU
<b>SKINTOP® BT-M</b>						
53017420	16 x 1,5	3,5-8	19	45,0	12,0	100
53017430	20 x 1,5	5-12	24	54,0	13,0	50
53017440	25 x 1,5	9-14	27	57,0	13,0	50

Photographs are not to scale and do not represent detailed images of the respective products.



**New**

**SKINTOP® MS-M / SKINTOP® MSR-M**



SKINTOP® MS-M

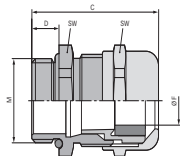

SKINTOP® MSR-M

**Benefits**

**SKINTOP® MS-M**

- Maximum reliability
- Optimum strain relief
- Wide, variable clamping ranges
- For cable diameters up to 98 mm

**SKINTOP® MSR-M**

- For the benefits, refer to SKINTOP® MS-M

**Application range**

**SKINTOP® MS-M**

- In areas where mechanical and chemical stability are critical
- Measurement and control technology

**SKINTOP® MSR-M**

- With reducing seal insert, to seal cables with smaller outer diameters.

**Approvals**



- UL File Nr. E79903

**Design**

- Metric connection thread acc. to EN 50262

**Note**

- Counter nut to be used: SKINDICHT® SM-M
- Refer to SKINTOP® metric accessories for suitable accessories

**Suitable cables**

**SKINTOP® MS-M**

- The following cables are recommended for IP 69 K applications:  
ÖLFLEX® ROBUST 200  
H07RN8-F  
H07RN-F



**Info**

- SKINTOP® MS-M sizes 75 x 1.5 to 110 x 2 with innovative double lamella gasket for easier assembling of cables with large diameters.
- Now with IP 69 K approval! Proven to withstand the most demanding cleaning procedures for industrial machinery with high-pressure cleaners and hot water!

**Technical data**



**Caution**

Refer to Appendix T21 for the installation dimensions and torques



**Approvals**

IP 69 K approval from size M75 x 1.5 pending. UL, CSA, DNV and VDE approval for sizes M90 x 2 to M110 x 2 pending.



**Material**

Body: nickel-plated brass  
Insert: polyamide  
Sealing ring: CR  
O-ring: NBR



**Protection rating**

IP 68  
IP 69 K



**Temperature range**

Dynamic: -30 °C to +100 °C  
Static: -40 °C to +100 °C

Article number	Article designation / size	Clamping range ØF (mm)	SW (mm)	Overall length, C (mm)	Thread length inner mm	Pieces / PU
<b>SKINTOP® MS-M/SKINTOP® MSR-M</b>						
53112000	12 x 1,5	3-7	16	26,5	6,5	100
53112010	16 x 1,5	4,5-10	20	32,0	7,0	100
53112020	20 x 1,5	7-13	24	35,5	8,0	50
53112030	25 x 1,5	9-17	29	37,5	8,0	25
53112040	32 x 1,5	11-21	36	42,2	9,0	25
53112050	40 x 1,5	19-28	45	49,5	9,0	10
53112060	50 x 1,5	27-35	54	52,0	10,0	5
53112070	63 x 1,5	34-45	67	61,3	15,0	5
53112080	63 x 1,5 plus	44-55	75	65,5	15,0	5
53112510	75 x 1,5	58-68	95	105,0	15,0	1
53112512	90 x 2	66-78	115	136,0	20,0	1
53112514	110 x 2	86-98	135	154,0	25,0	1
<b>SKINTOP® MSR-M</b>						
53112100	12 x 1,5	1-5	16	26,5	6,5	100
53112110	16 x 1,5	2-7	20	32,0	7,0	100
53112120	20 x 1,5	5-10	24	35,5	8,0	50
53112130	25 x 1,5	6-13	29	37,5	8,0	25
53112140	32 x 1,5	7-15	36	42,2	9,0	25
53112150	40 x 1,5	15-23	45	49,5	9,0	10
53112160	50 x 1,5	22-29	54	52,0	10,0	5
53112170	63 x 1,5	28-39	67	61,3	15,0	5
53112511	75 x 1,5	53-63	95	105,0	15,0	1
53112515	110 x 2	76-88	135	154,0	25,0	1

Photographs are not to scale and do not represent detailed images of the respective products.

**Accessories**

**SKINTOP® MS-M**

- SKINDICHT® SM-M refer to page 111
- SKINTOP® DIX-M refer to page 108
- SKINMATIC® MH Set refer to main catalogue 2012 page 710
- SKINTOP® DIX-M AUTOMATION refer to page 109
- SKINTOP® SDV-M ATEX refer to main catalogue 2012 page 674
- SKINTOP® SD-M refer to main catalogue 2012 page 675
- SKINTOP® DV-M refer to main catalogue 2012 page 675

**SKINTOP® MSR-M**

- SKINDICHT® SM-M refer to page 111
- SKINTOP® SDVR-M ATEX refer to main catalogue 2012 page 674
- SKINTOP® SD-M refer to main catalogue 2012 page 675

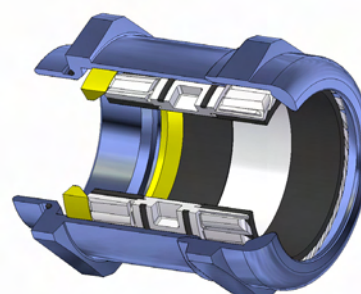

**SKINTOP® MSR-M-XL / SKINTOP® MS-M-XL**

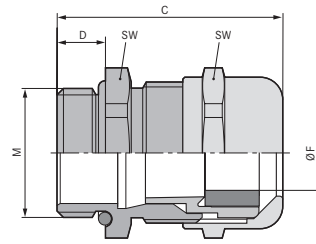

**Benefits**

**SKINTOP® MS-M-XL**

- Especially for thick walls
- Maximum reliability
- Optimum strain relief
- Wide, variable clamping ranges

**SKINTOP® MSR-M-XL**

- For the benefits, refer to SKINTOP® MS-M-XL

**Application range**

**SKINTOP® MS-M-XL**

- With long connection thread for applications involving a thicker wall.

**SKINTOP® MSR-M-XL**

- With reducing seal insert, to seal cables with smaller outer diameters.

**Approvals**



- UL File Nr. E79903

**Design**

- Metric connection thread acc. to EN 50262

**Note**

- Counter nut to be used: SKINDICHT® SM-M
- Refer to SKINTOP® metric accessories for suitable accessories

**Technical data**



**Caution**

Refer to Appendix T21 for the installation dimensions and torques



**Material**

Body: nickel-plated brass  
Insert: polyamide  
Sealing ring: CR  
O-ring: NBR



**Protection rating**

Remark: A RoHS-non-compliant version is marketed under ÖLFLEX® 110 with VDE-REG.-Nr. 8067. To order this, please add appendix <1> to the below stated part numbers. This does not affect the above given further technical data or description.

IP 69 K  
IP 68 - 10 bar



**Temperature range**

Dynamic: -30 °C to +100 °C  
Static: -40°C to +100°C

Article number	Article designation / size	Clamping range ØF (mm)	SW (mm)	Overall length, C (mm)	Thread length inner mm	Pieces / PU
<b>SKINTOP® MS-M-XL</b>						
53112005	12 x 1,5	3-7	16	32.8	12.0	100
53112015	16 x 1,5	4,5-10	20	37.0	12.0	50
53112025	20 x 1,5	7-13	24	39.5	12.0	50
53112035	25 x 1,5	9-17	29	41.5	12.0	25
53112045	32 x 1,5	11-21	36	48.2	15.0	25
53112055	40 x 1,5	19-28	45	53.5	15.0	10
53112065	50 x 1,5	27-35	54	57.0	15.0	5
<b>SKINTOP® MSR-M-XL</b>						
53112105	12 x 1,5	1-5	16	32.8	12.0	100
53112115	16 x 1,5	2-7	20	37.0	12.0	50
53112125	20 x 1,5	5-10	24	39.5	12.0	50
53112135	25 x 1,5	6-13	29	41.5	12.0	25
53112145	32 x 1,5	7-15	36	48.2	15.0	25
53112155	40 x 1,5	15-23	45	53.5	15.0	10
53112165	50 x 1,5	22-29	54	57.0	15.0	5

Photographs are not to scale and do not represent detailed images of the respective products.

## SKINTOP® MS-SC-M



SKINTOP® MS-SC-M-XL

SKINTOP® MS-SC-M

### Benefits

- Suitable for cables with and without inner sheath
- Also suitable for continuing the cable screen to another connection
- Low-resistance screen contact, optimum EMC protection
- Highly conductive, flexible EMC contact for clamping various screen diameters
- Few operation steps, easy to assemble

### Application range

- For EMC-compliant earthing of the copper braiding, or for cables with copper shaft sheath
- Industrial machinery
- Measurement and control technology
- Automation technology

### Approvals



- UL File Nr. E79903

### Design

- Metric connection thread acc. to EN 50262

### Note

- SKINDICHT® SM-PE-M counter nut should be used to ensure optimum contact with painted, anodised or powder-coated housings
- Refer to SKINTOP® metric accessories for suitable accessories
- As an alternative for thick-walled housings, we recommend SKINTOP® MS-SC-M-XL with long connection thread in the sizes M16 to M50

### Technical data



#### Caution

Refer to Appendix T21 for the installation dimensions and torques



#### Material

Body: nickel-plated brass  
Insert: polyamide  
Sealing ring: CR  
O-ring: NBR



#### Protection rating

Remark: A RoHS-non-compliant version is marketed under ÖLFLEX® 110 with VDE-REG.-Nr. 8067. To order this, please add appendix <1> to the below stated part numbers. This does not affect the above given further technical data or description.  
IP 68 - 10 bar



#### Temperature range

-30°C to +100°C

Article number	Article designation / size	Minimum Ø above braiding (mm)	SW (mm)	Thread length inner mm	Pieces / PU
<b>SKINTOP® MS-SC-M</b>					
53112610	12 x 1,5	2.0	16	6.5	50
53112620	16 x 1,5	4.0	20	7.0	50
53112630	20 x 1,5	5.0	24	8.0	25
53112640	25 x 1,5	7.5	29	8.0	25
53112650	32 x 1,5	9.0	36	9.0	25
53112660	40 x 1,5	15.0	45	9.0	10
53112670	50 x 1,5	21.0	54	10.0	5
<b>SKINTOP® MS-SC-M-XL</b>					
53112625	16 x 1,5	4.0	20	12.0	50
53112635	20 x 1,5	5.0	24	12.0	25
53112645	25 x 1,5	7.5	29	12.0	25
53112655	32 x 1,5	9.0	36	15.0	25
53112665	40 x 1,5	15.0	45	15.0	10
53112675	50 x 1,5	21.0	54	15.0	5

Photographs are not to scale and do not represent detailed images of the respective products.

### Accessories

- SKINDICHT® SM-PE-M refer to page 111

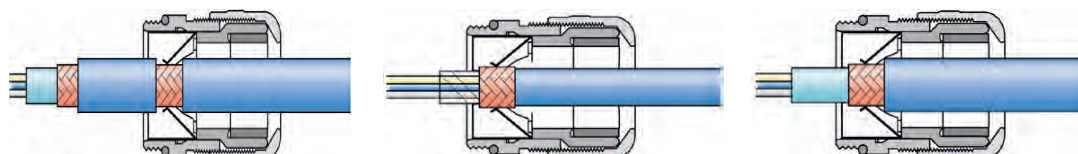

**New**

**SKINTOP® MS-M BRUSH**

**Benefits**

- Faster, easier screen contact
- Optimum, F8480 low-resistance 360° screen contact
- Faster than any other comparable system
- Uncomplicated and reliable
- Maximum assembly freedom during adjustment

**Application range**

- For EMC-compliant earthing of the copper braiding, or for cables with copper shaft sheath
- Automation systems
- High-power drives
- Frequency converters

**Approvals**



- UL File Nr. E79903

**Design**

- Metric connection thread acc. to EN 50262

**Note**

- SKINDICHT® SM-PE-M counter nut should be used to ensure optimum contact with painted, anodised or powder-coated housings



**Info**

- SKINTOP® MS-M BRUSH sizes 75 x 1.5 to 110 x 2 with innovative double lamella gasket for easier assembling of cables with large diameters.

**Technical data**



**Caution**

Refer to Appendix T21 for the installation dimensions and torques



**Approvals**

VDE, UL, CSA, DNV approval for size M90 x 2 and 110 x 2 pending  
SKINTOP® MSR-M BRUSH 25 x 1,5 approvals pending



**Material**

Body: nickel-plated brass  
EMC brush: brass  
Sealing ring: special elastomer  
O-ring: special elastomer



**Protection rating**

IP 68  
IP 69 K (M25x1,5 - M63x1,5)



**Temperature range**

Dynamic: -30 °C to +100 °C  
Static: -40 °C to +100 °C

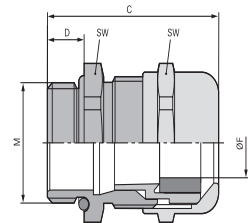

Article number	Article designation / size	Minimum Ø above braiding (mm)	SW (mm)	Thread length inner mm	Pieces / PU
<b>SKINTOP® MSR-M BRUSH 25 x 1,5 approvals pending</b>					
53112671	25 x 1,5	5.0	29	8.0	10
<b>SKINTOP® MS-M BRUSH</b>					
53112676	25 x 1,5	6.0	29	8.0	10
53112677	32 x 1,5	8.0	36	9.0	1
53112678	40 x 1,5	10.0	45	9.0	1
53112679	50 x 1,5	14.0	54	10.0	1
53112680	63 x 1,5	20.0	67	15.0	1
53112681	63 x 1,5 plus	25.0	75	15.0	1
53112501	75 x 1,5	35.0	95	15.0	1
53112500	75 x 1,5 plus	35.0	95	15.0	1
53112503	90 x 2	45.0	115	20.0	1
53112505	110 x 2	55.0	135	25.0	1
53112504	110 x 2 plus	55.0	135	25.0	1

Photographs are not to scale and do not represent detailed images of the respective products.

**Accessories**

- SKINDICHT® SM-PE-M refer to page 111

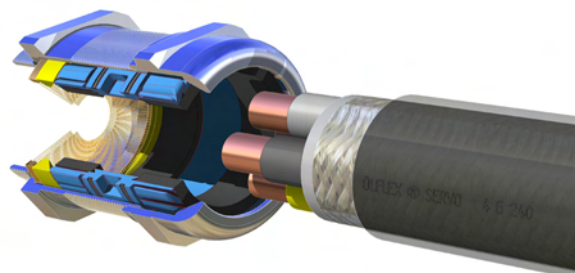

**New**

## SKINTOP® BRUSH ADD-ON

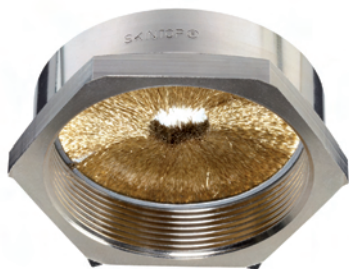

### Benefits

- Optimum, F8480 low-resistance 360° screen contact
- Cutting edges cut through the insulating layer of the housing or switch cabinets, thus guaranteeing an optimum EMC contact
- Easy disassembling
- Visible, large-scale screen contact
- Uncomplicated and reliable

### Application range

- For EMC-compliant earthing of the copper braiding, or for cables with copper shaft sheath
- For EMC-contact at through bore-holes
- Control cabinet manufacturing
- Automation systems
- Conveyor and transport systems

### Approvals



### Design

- Metric connection thread acc. to EN 50262



### Info

- Innovative EMC add-on for SKINTOP® ST(R)-M polyamide cable glands.
- Worlds first patented active EMC lock-nut!

### Technical data



#### Caution

Refer to Appendix T21 for the installation dimensions and torques



#### Approvals

UL pending



#### Material

Body: nickel-plated brass  
EMC brush: brass



#### Temperature range

-70°C to +200°C

Article number	Article designation / size	Minimum Ø above braiding (mm)	SW (mm)	Thread length inner mm	Pieces / PU
54110840	M 16 x 1,5	5.0	24	10.0	25
54110841	M 20 x 1,5	5.0	24	10.0	10
54110842	M 25 x 1,5	5.0	30	10.0	10
54110843	M 32 x 1,5	8.0	39	12.0	10
54110844	M 40 x 1,5	10.0	47	12.0	5
54110845	M 50 x 1,5	14.0	56	12.0	5

Photographs are not to scale and do not represent detailed images of the respective products.

### Accessories

- SKINTOP® BS-M refer to page 100
- SKINTOP® ST-M refer to page 97
- SKINTOP® STR-M refer to page 97
- SKINTOP® BT-M refer to page 101
- SKINTOP® ST-HF-M refer to main catalogue 2012 page 656
- SKINTOP® COLD refer to main catalogue 2012 page 664
- SKINTOP® COLD-R refer to main catalogue 2012 page 664

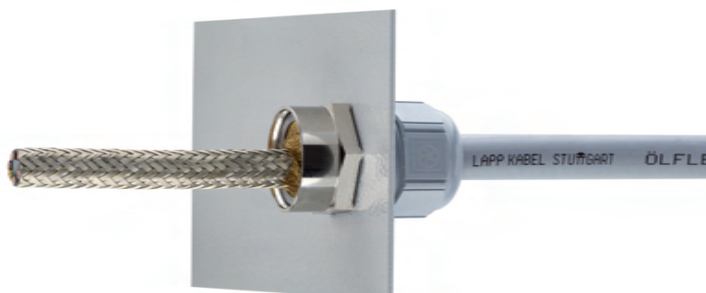

**SKINTOP® GMP-GL-M**



SKINTOP® GMP-GL-M

**Benefits**

- Glass fibre-reinforced for maximum mechanical stability
- Supporting surface for spanner means scratches on the housing are avoided

**Application range**

- For locking SKINTOP® cable glands in bore-holes without thread.

**Approvals**



- UL File Nr. E79903

**Design**

- Metric connection thread acc. to EN 50262

**Note**

- UL approval only when used with the UL-approved SKINTOP® polyamide cable glands
- Designed for use with metric SKINTOP® plastic cable glands

**Technical data**

**On request**  
Available without collar (without surface for assembling tool)

**Colour delivered**  
Silver grey (RAL 7001)  
Light grey (RAL 7035)  
Black (RAL 9005), UV-resistant

**Material**  
Polyamide, glass fibre-reinforced

**Temperature range**  
Dynamic: -20°C to +100°C  
Static: -40°C to +100°C

Article number	Article designation / size	SW (mm)	Pieces / PU
<b>SKINTOP® GMP-GL-M silver grey</b>			
53119000	12 x 1,5	17	100
53119010	16 x 1,5	22	100
53119020	20 x 1,5	27	100
53119030	25 x 1,5	34	100
53119040	32 x 1,5	41	100
53119050	40 x 1,5	50	25
53119060	50 x 1,5	60	25
53119070	63 x 1,5	75	25
<b>SKINTOP® GMP-GL-M black</b>			
53119100	12 x 1,5	17	100
53119110	16 x 1,5	22	100
53119120	20 x 1,5	27	100
53119130	25 x 1,5	34	100
53119140	32 x 1,5	41	100
53119150	40 x 1,5	50	25
53119160	50 x 1,5	60	25
53119170	63 x 1,5	75	25
<b>SKINTOP® GMP-GL-M light grey</b>			
53119003	12 x 1,5	17	100
53119013	16 x 1,5	22	100
53119023	20 x 1,5	27	100
53119033	25 x 1,5	34	100
53119043	32 x 1,5	41	100
53119053	40 x 1,5	50	25
53119063	50 x 1,5	60	25
53119073	63 x 1,5	75	25

Photographs are not to scale and do not represent detailed images of the respective products.

## SKINTOP® DIX-M



## ■ Benefits

- Easy insertion of several cables into one gland
- Higher packing density allows smaller part construction

## ■ Application range

- For use in SKINTOP® cable glands.
- A sealing ring with several holes is used in place of the inner sealing insert.

## ■ Approvals



## ■ Note

- IP 68 can be achieved when all openings are closed and all bores are optimally occupied, i.e. when using cables with nominal diameter and/or SKINTOP® DIX-DV sealing plugs

## ■ Design

- SKINTOP® DIX-M VITON® is resistant to oil, water, alkaline solutions, acids, solvents etc.

## ■ Technical data

	<b>On request</b> Special shapes
	<b>Colour delivered</b> Black (RAL 9005)
	<b>Material</b> NBR VITON®
	<b>Protection rating</b> IP 54
	<b>Temperature range</b> -40 °C to +100 °C

Article number	Article designation / size	Size M	Number of cables x cable Ø	Pieces / PU
<b>SKINTOP® DIX-M</b>				
53316220	16,220	M 16	2 x 2.0	100
53316230	16,230	M 16	2 x 3.0	100
53316240	16,240	M 16	2 x 4.0	100
53320250	20,250	M 20	2 x 5.0	100
53320260	20,260	M 20	2 x 6.0	100
53320340	20,340	M 20	3 x 4.0	100
53320353	20,353	M 20	3 x 5.3	100
53320440	20,440	M 20	4 x 4.0	100
53320920	20,920	M 20	9 x 2.0	100
53320430	20,430	M 20	4 x 3.0	100
53325260	25,260	M 25	2 x 6.0	50
53325350	25,350	M 25	3 x 5.0	50
53325360	25,360	M 25	3 x 6.0	50
53325370	25,370	M 25	3 x 7.0	50
53325450	25,450	M 25	4 x 5.0	50
53325540	25,540	M 25	5 x 4.0	50
53325640	25,640	M 25	6 x 4.0	50
53332270	32,270	M 32	2 x 7.0	50
53332280	32,280	M 32	2 x 8.0	50
53332290	32,290	M 32	2 x 9.0	50
53332370	32,370	M 32	3 x 7.0	50
53332380	32,380	M 32	3 x 8.0	50
53332460	32,460	M 32	4 x 6.0	50
53332470	32,470	M 32	4 x 7.0	50
53332560	32,560	M 32	5 x 6.0	50
53332650	32,650	M 32	6 x 5.0	50
53332840	32,840	M 32	8 x 4.0	50
53332850	32,850	M 32	8 x 5.0	50
53332940	32,940	M 32	9 x 4.0	50
53340290	40,290	M 40	2 x 9.0	25
53340310	40,310	M 40	3 x 10.0	25
53340480	40,480	M 40	4 x 8.0	25
53340490	40,490	M 40	4 x 9.0	25
53340580	40,580	M 40	5 x 8.0	25
53340590	40,590	M 40	5 x 9.0	25
53340670	40,670	M 40	6 x 7.0	25
53340860	40,860	M 40	8 x 6.0	25
53340969	40,969	M 40	9 x 6.9	25
53350118	50,118	M 50	11 x 8.0	10
53350680	50,680	M 50	6 x 8.0	10
53350780	50,780	M 50	7 x 8.0	10
53350870	50,870	M 50	8 x 7.0	10
53350147	50,147	M 50	14 x 7.0	10
53350164	50,164	M 50	16 x 4.0	10
53350166	50,166	M 50	16 x 6.0	10
<b>SKINTOP® DIX-M VITON®</b>				
53420250	20,250	M 20	2 x 5.0	100
53420260	20,260	M 20	2 x 6.0	100
53440969	40,969	M 40	9 x 6.9	25

Viton® is a registered trademark of DuPont de Nemours

Photographs are not to scale and do not represent detailed images of the respective products.

## ■ Accessories

- SKINTOP® CLICK refer to page 99
- SKINTOP® ST-M refer to page 97
- SKINTOP® DIX-DV refer to main catalogue 2012 page 675

**New**

**SKINTOP® DIX-M AUTOMATION**



SKINTOP® DIX-M AUTOMATION

**Benefits**

- Optimal seal when using AS-I bus cables
- Easy insertion of pre-assembled cables (with fieldbus or RJ-45 connector)
- Strain relief

**Application range**

- These seals can be used instead of our standard seals in the SKINTOP® cable glands.
- Control cabinets
- Control panels
- Office applications
- Automation technology

**Approvals**



**Note**

- IP 68 can be achieved if the hole is optimally occupied, i.e. when using standard AS-I bus cables

**Design**

- Precise cut for AS-I bus cables
- Seal with hole and cut for easy insertion of pre-assembled RJ45 network cables
- Seal with hole and cut for easy insertion of pre-assembled field bus cables
- Multiple seal inserts with holes and slits for easy insertion of pre-assembled cables

**Technical data**

**RAL** Colour delivered  
Black (RAL 9005)

**Material**  
NBR

**IP** Protection rating  
IP 54

**Temperature range**  
-40°C to +100°C

Article number	Article designation / size	Number of cables x cable Ø	Pieces / PU
<b>SKINTOP® DIX-M ASI</b>			
53611001	M 20	1 x AS-I	50
<b>SKINTOP® DIX-M ASI DUO</b>			
53611004	M 25	2 x AS-I	50
<b>SKINTOP® DIX-M RJ-45</b>			
53440980	M 25	1 x 5.4	50
<b>SKINTOP® DIX-M FIELDBUS</b>			
53440970	M 32	1 x 6.5	50
<b>SKINTOP® DIX-M CUT</b>			
53310444	M 40	3 x 10.0	25

Photographs are not to scale and do not represent detailed images of the respective products.

**Accessories**

- SKINTOP® CLICK refer to page 99
- SKINTOP® MS-M refer to page 102
- SKINTOP® ST-M refer to page 97



**New**

# SKINTOP® CUBE



SKINTOP® CUBE



SKINTOP® CUBE FRAME



SKINTOP® CUBE MODULE



**Info**

- Innovative multi-cable bushing system with variable clamping ranges for high flexibility in assembling.
- When disassembling, the frame can remain on the housing and the plug-in module remains securely on the cable.
- UL in pending

**Benefits**

- Variable range of clamping force
- Vibration-safe module fixation
- Strain relief
- Oil resistance
- Simplified servicing due to easy assembling and disassembling

**Application range**

- For installation of harnessed cables
- Used in areas where cables and wires need to be safely inserted into housings
- Apparatus and switch cabinet construction
- Electronic installations
- Automation technology

**Approvals**



**Design**

- The SKINTOP® CUBE system consists of the SKINTOP® CUBE FRAME and the clip modules SKINTOP® CUBE MODULE.
- For cut-outs for industrial connectors with standard defined boreholes.
- For cut-outs for 16-pin industrial connectors (36 x 86 mm)
- For cut-outs for 24-pin industrial connectors (36 x 112 mm)

**Note**

- SKINTOP® CUBE MODULE 20x20 BLIND can be used as a blind module and for clamping ranges 1 - 3 mm

**Included**

- SKINTOP® CUBE FRAME including mounting material

**Suitable tools**

- Kraftform Kompakt® 10

**Technical data**



**Approvals**  
UL pending



**Material**  
Frame: glass fibre-reinforced polyamide  
Frame seal: CR  
Clip module: special polypropylene  
Clip module seal: LSE 2



**Protection rating**  
IP 64  
NEMA 12



**Temperature range**  
-20°C to +80°C

Article number	Article designation / size	Clamping range ØF (mm)	Max. number of executions	Pieces / PU
<b>SKINTOP® CUBE Frame</b>				
52220000	SKINTOP® CUBE FRAME 16		8	1
52220001	SKINTOP® CUBE FRAME 24		10	1
<b>SKINTOP® CUBE clip modules</b>				
52220004	SKINTOP® CUBE MODULE 20x20 BLIND	1 - 3		5
52220002	SKINTOP® CUBE MODULE 20x20 SMALL	4 - 6		5
52220003	SKINTOP® CUBE MODULE 20x20 LARGE	6 - 9		5
52220040	SKINTOP® CUBE MODULE 20x20 AS-I BUS			5
52220005	SKINTOP® CUBE MODULE 40x40 SMALL	9 - 12		5
52220006	SKINTOP® CUBE MODULE 40x40 LARGE	12 - 16		5
52220007	SKINTOP® CUBE MODULE 40x40 BLIND			5

Photographs are not to scale and do not represent detailed images of the respective products.

**Similar products**

- SKINDICHT® CABLEFIX cable bushing system

**Accessories**

- FLEXIMARK® LB-10 W



**SKINDICHT® SM-M**



SKINDICHT® SM-M

**Application range**

- Used when a gland has to be countered, or in through-holes on thin-walled housings

**Approvals**



**Design**

- Metric connection thread acc. to EN 50262

**Technical data**

**Material**  
Nickel-plated brass

Article number	Article designation / size	Thickness (mm)	SW (mm)	Outer Ø (mm)	Pieces / PU
<b>SKINDICHT® SM-M</b>					
52103000	12 x 1,5	3.0	15	16.5	100
52103010	16 x 1,5	3.0	19	20.9	100
52103020	20 x 1,5	3.5	24	26.4	100
52103030	25 x 1,5	4.0	30	33.0	100
52103040	32 x 1,5	4.0	36	39.6	100
52103050	40 x 1,5	5.0	46	50.6	50
52103060	50 x 1,5	5.0	60	66.0	50
52103070	63 x 1,5	5.0	70	77.0	25
52103071	75 x 1,5	8.0	85	95.0	5
52103072	90 x 2	10.0	102	114.0	1
52103073	110 x 2	12.0	124	135.0	1

Photographs are not to scale and do not represent detailed images of the respective products.

**SKINDICHT® SM-PE-M**



SKINDICHT® SM-PE-M

**Benefits**

- Cutting edges cut through the insulating layer, thus guaranteeing an optimum EMC contact
- Suitable for all metric glands used in earthing and EMC applications

**Approvals**



**Design**

- Metric connection thread acc. to EN 50262

**Technical data**

**Material**  
Nickel-plated brass

**Application range**

- For lacquered, anodised or powder-coated housings.

Article number	Article designation / size	Thickness (mm)	SW (mm)	Outer Ø (mm)	Pieces / PU
<b>SKINDICHT® SM-PE-M</b>					
52103300	12 x 1,5	3.5	15	16.5	100
52103310	16 x 1,5	3.5	19	20.9	100
52103320	20 x 1,5	3.7	24	26.4	100
52103330	25 x 1,5	4.2	30	33.0	50
52103340	32 x 1,5	4.7	36	39.6	50
52103350	40 x 1,5	5.5	46	50.6	25
52103360	50 x 1,5	5.5	60	66.0	10
52103370	63 x 1,5	7.0	70	77.0	10
52103371	75 x 1,5	8.0	85	95.0	5
52103372	90 x 2	10.0	102	114.0	1
52103373	110 x 2	12.0	124	135.0	1

Photographs are not to scale and do not represent detailed images of the respective products.

**New**

## SKINDICHT® MR-M hexagonal

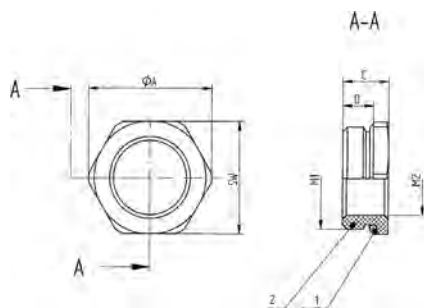

### Benefits

- Enables the use of cable glands with smaller connection threads than the existing threaded holes
- With guide notch for O-ring
- Assembling with a wrench

### Application range

- Machines
- Devices
- Housings

### Approvals



### Design

- Metric connection thread acc. to EN 50262

### Technical data

- On request**  
VITON® O-ring  
-20 °C to +200 °C
- Material**  
Body: nickel-plated brass  
O-ring: NBR
- Temperature range**  
-30°C to +100°C

Article number	Thread, male M1	Thread, female M2	SW (mm)	ØA [mm]	Overall length, C (mm)	Thread length inner mm	Outer Ø (mm)	Pieces / PU
<b>SKINDICHT® MR-M hexagon</b>								
52101965	16 x 1.5	12 x 1.5	18	20.2	8.5	5.5		50
52101966	20 x 1.5	16 x 1.5	22	24.4	9.0	6.0		50
52101967	25 x 1.5	16 x 1.5	28	31.2	10.0	6.5		50
52101968	25 x 1.5	20 x 1.5	28	31.2	10.0	6.5		50
52101969	32 x 1.5	16 x 1.5	36	40.0	11.5	8.0		25
52101972	32 x 1.5	20 x 1.5	36	40.0	11.5	8.0		25
52101973	32 x 1.5	25 x 1.5	36	40.0	11.5	8.0		25
52101974	40 x 1.5	25 x 1.5	43	47.5	12.5	8.5		10
52101975	40 x 1.5	32 x 1.5	43	47.5	12.5	8.5		10
52101976	50 x 1.5	40 x 1.5	54	58.0	14.0	10.0		5
52101977	63 x 1.5	50 x 1.5	67	74.0	14.0	9.5		5
52101979	75 x 1.5	63 x 1.5	80	90.0	17.0	11.0		1
<b>SKINDICHT® MR-M, blank brass, with hexagon</b>								
52006572	80 x 2	63 x 1.5	85		23.0	15.0	93.5	1
<b>SKINDICHT® MR-M, blank brass</b>								
52006579	80 x 2	75 x 1.5			19.0	12.0	86.0	1
<b>SKINDICHT® MR-M, nickel-plated brass</b>								
52006575	72 x 2	63 x 1.5			19.0	12.0	78.0	1

Viton® is a registered trademark of DuPont de Nemours  
Photographs are not to scale and do not represent detailed images of the respective products.

**SILVYN® RILL PA 6**

**Info**

- Maximum safety in the event of a fire



SILVYN® RILL PA 6

**Benefits**

- Dimensionally stable
- Flexible
- High flame-retardance and self-extinguishing in accordance with UL 94V-0
- Crush-resistant
- Lightweight

**Application range**

- Mechanical engineering
- Moving applications
- Outdoor application (in black)
- Nacelle
- Pitch system
- Foundation
- Yaw drives
- Tower

**Product features**

- Halogen and cadmium-free
- Abrasion-resistant
- High resistance to oil, petrol, acids and other chemicals

**Approvals**



**Design**

- Fine-profile corrugated polyamide 6 conduit

**Note**

- UV and weather-resistant in black

**Technical data**

**DIN VDE Approvals**  
 UR File No. E308201  
 VDE EN/IEC 618386-23  
 DNV, Lloyd's Register  
 Rail:  
 DB DIN 5510 Teil2 (S4/SR2/ST2)  
 SNCF NFF16-101/102 (I2/f2)  
 UNDERGROUND BS 6853

**RAL Colour delivered**  
 Grey (RAL 7001)  
 Black (RAL 9005), UV-resistant

**Material**  
 PA 6  
 Silicone-free  
 Halogen-free  
 UL 94V-0

**Temperature range**  
 dynamic: -20°C to +115°C  
 static: -40°C to +115°C  
 short-term +150°C

Article number	Article designation	Article Ø x OØ (mm)	Bending radius (mm)	Suitable for SILVYN® KLICK-GM/WM	Suitable for SILVYN® KLICK-GP/WP	Suitable for SILVYN® KLICK-GPZ-M/GPZ	PU ring (m)
<b>SILVYN® RILL PA 6 grey</b>							
61746939	7	6.5 x 10.0	13	10 x 1,0	7/-	12 x 1,5/7	50
61746940	9	10.0 x 13.0	20	12 x 1,5/16 x 1,5	9/9	16x1,5/9	50
61746950	11	12.0 x 15.8	35	16 x 1,5/20 x 1,5	11/11	20x1,5/11	50
61747010	13,5	14.3 x 18.5	40		13,5/13,5	-/13,5	50
61746960	16	16.5 x 21.2	45	20 x 1,5	16/16	25x1,5/16	50
61746970	21	23.0 x 28.5	55	25 x 1,5	21/21	32x1,5/21	50
61746980	29	29.0 x 34.5	65	32 x 1,5	29/29	40x1,5/29	25
61746990	36	36.0 x 42.5	90	40 x 1,5	36/-	50x1,5/36	25
61747000	48	48.0 x 54.5	100	50 x 1,5	48/-	63x1,5/48	25
<b>SILVYN® RILL PA 6 black</b>							
61746935	7	6.5 x 10.0	13	10 x 1,0	7/-	12 x 1,5/7	50
61746945	9	10.0 x 13.0	20	12 x 1,5/16 x 1,5	9/9	16x1,5/9	50
61746955	11	12.0 x 15.8	35	16 x 1,5/20 x 1,5	11/11	20x1,5/11	50
61747015	13,5	14.3 x 18.5	40		13,5/13,5	-/13,5	50
61746965	16	16.5 x 21.2	45	20 x 1,5	16/16	25x1,5/16	50
61746975	21	23.0 x 28.5	55	25 x 1,5	21/21	32x1,5/21	50
61746985	29	29.0 x 34.5	65	32 x 1,5	29/29	40x1,5/29	25
61746995	36	36.0 x 42.5	90	40 x 1,5	36/-	50x1,5/36	25
61747005	48	48.0 x 54.5	100	50 x 1,5	48/-	63x1,5/48	25

Photographs are not to scale and do not represent detailed images of the respective products.

**Similar products**

- SILVYN® RILL PA 12 refer to main catalogue 2012 page 783

**Accessories**

- SILVYN® KLICK-GM refer to page 114
- SILVYN® KLICK 90°M refer to page 115
- SILVYN® KLICK GPZ-M refer to page 116
- SILVYN® KLICK- 90° Flange refer to main catalogue 2012 page 785
- SILVYN® KSE refer to main catalogue 2012 page 787
- SILVYN® KLICK-GP refer to main catalogue 2012 page 788
- SILVYN® KLICK 90° PG refer to main catalogue 2012 page 790
- SILVYN® KLICK-GPZ refer to main catalogue 2012 page 789
- SILVYN® KLICK-Y refer to main catalogue 2012 page 791
- SILVYN® KLICK-Y (TPE) refer to main catalogue 2012 page 791
- SILVYN® KLICK-S refer to main catalogue 2012 page 792
- SILVYN® KLICK-D refer to main catalogue 2012 page 792
- SILVYN® KLICK-V refer to main catalogue 2012 page 792
- SILVYN® KLICK-RH refer to main catalogue 2012 page 793
- SILVYN® K-EM refer to main catalogue 2012 page 793

## SILVYN® KLICK-GM



### Benefits

- Fast assembly
- Easy to disassemble
- High-tensile
- High sealing performance
- Can be rotated

### Application range

- In combination with protective conduit
- SILVYN® RILL PA6
- SILVYN® RILL PA12
- Rotating applications
- Nacelle
- Pitch system
- Foundation
- Yaw drives

### Approvals



- UL FILENUMBER E308201

### Design

- Metric connection thread
- Body with inner sealing
- Upper part with snap-in sleeve

### Technical data

**RAL** Colour delivered  
 Grey (RAL 7001)  
 Black (RAL 9005), UV-resistant

**Material**  
 PA6

**IP** Protection rating  
 IP 68  
 IP 69K according to DIN 40050 T.9

**Temperature range**  
 dynamic: -20°C to +115°C  
 static: -40°C to +115°C

### Note

- For rotating applications, disassemble the upper part to remove sealing, then re-assemble.

### Suitable conduits

- SILVYN® RILL PA 6
- SILVYN® RILL PA 12

Article number	Connection thread M	Hole Ø (mm)	For conduit with outer Ø (mm)	Thread length, D (mm)	SW (mm)	Suitable for SILVYN® RILL	Pieces / PU
<b>SILVYN® KLICK-GM grey</b>							
55501000	10 x 1.0	6.5	10.0	12.0	17.0	6,5 x 10,0	50.0
55501010	12 x 1.5	8.0	13.0	12.0	20.0	10 x 13,0	50.0
55501020	16 x 1.5/1	10.0	13.0	12.0	20.0	10 x 13,0	50.0
55501030	16 x 1.5/2	12.0	15.8	12.0	23.0	12 x 15,8	50.0
55501040	20 x 1.5/1	12.0	15.8	13.0	23.0	12 x 15,8	50.0
55501050	20 x 1.5/2	16.0	21.2	13.0	29.5	16,5 x 21,2	50.0
55501060	25 x 1.5	20.5	28.5	13.0	37.0	23 x 28,5	25.0
55501070	32 x 1.5	27.5	34.5	15.0	44.0	29 x 34,5	25.0
55501080	40 x 1.5	35.0	42.5	15.0	51.5	36 x 42,5	25.0
55501090	50 x 1.5	45.0	54.5	15.3	65.5	48 x 54,5	10.0
55500990	63 x 1.5	48.0	54.5	16.0	59.0	48 x 54,5	10.0
<b>SILVYN® KLICK-GM black</b>							
55501005	10 x 1.0	6.5	10.0	12.0	17.0	6,5 x 10,0	50.0
55501015	12 x 1.5	8.0	13.0	12.0	20.0	10 x 13,0	50.0
55501025	16 x 1.5/1	10.0	13.0	12.0	20.0	10 x 13,0	50.0
55501035	16 x 1.5/2	12.0	15.8	12.0	23.0	12 x 15,8	50.0
55501045	20 x 1.5/1	12.0	15.8	13.0	23.0	12 x 15,8	50.0
55501055	20 x 1.5/2	16.0	21.2	13.0	29.5	16,5 x 21,2	50.0
55501065	25 x 1.5	20.5	28.5	13.0	37.0	23 x 28,5	25.0
55501075	32 x 1.5	27.5	34.5	15.0	44.0	29 x 34,5	25.0
55501085	40 x 1.5	35.0	42.5	15.0	51.5	36 x 42,5	25.0
55501095	50 x 1.5	45.0	54.5	15.3	65.5	48 x 54,5	10.0
55500995	63 x 1.5	48.0	54.5	16.0	59.0	48 x 54,5	10.0

Photographs are not to scale and do not represent detailed images of the respective products.

### Similar products

- SILVYN® KLICK GPZ-M refer to page 116

**SILVYN® KLICK 90°M**



**Benefits**

- 90° elbow enables best assembling
- Fast assembly
- Easy to disassemble
- High-tensile
- High sealing performance

**Application range**

- In combination with protective conduit
- SILVYN® RILL PA6
- SILVYN® RILL PA12
- Nacelle
- Pitch system
- Foundation
- Yaw drives

**Approvals**



- UL FILENUMBER E308201

**Design**

- Metric connection thread
- 90° elbow
- Body with inner sealing
- Upper part with snap-in sleeve

**Technical data**

<b>RAL</b>	<b>Colour delivered</b> Grey (RAL 7001) Black (RAL 9005), UV-resistant
<b>Material</b>	PA6
<b>IP</b>	<b>Protection rating</b> IP 68 IP 69K according to DIN 40050 T.9
<b>Temperature range</b>	dynamic: -20°C to +115°C static: -40°C to +115°C

**Note**

- For rotating applications, disassemble the upper part to remove sealing, then re-assemble.

**Suitable conduits**

- SILVYN® RILL PA 6
- SILVYN® RILL PA 12

Article number	Connection thread M	Hole Ø (mm)	For conduit with outer Ø (mm)	Thread length, D (mm)	Suitable for SILVYN® RILL	Pieces / PU
<b>SILVYN® KLICK-WM grey</b>						
55501110	10 x 1.0	7.0	10.0	12.0	6,5 x 10,0	50.0
55501120	12 x 1.5	8.0	13.0	12.0	10,0 x 13,0	50.0
55501130	16 x 1.5/1	12.0	13.0	12.0	10,0 x 13,0	50.0
55501140	16 x 1.5/2	12.0	15.8	12.0	12 x 15,8	50.0
55501150	20 x 1.5/1	15.5	15.8	13.0	12 x 15,8	50.0
55501160	20 x 1.5/2	15.5	21.2	13.0	16,5 x 21,2	50.0
55501170	25 x 1.5/1	18.0	21.2	13.0	16,5 x 21,2	50.0
55501180	25 x 1.5/2	18.0	28.5	13.0	23 x 28,5	25.0
55501190	32 x 1.5/1	24.0	28.5	15.0	23 x 28,5	25.0
55501200	32 x 1.5/2	24.0	34.5	15.0	29 x 34,5	10.0
55501210	40 x 1.5/1	32.0	34.5	15.0	29 x 34,5	10.0
55501220	40 x 1.5/2	32.0	42.5	15.0	36 x 42,5	10.0
55501230	50 x 1.5/1	39.0	42.5	16.0	36 x 42,5	10.0
55501240	50 x 1.5/2	39.0	54.5	16.0	48 x 54,5	5.0
55501250	63 x 1.5	53.0	54.5	16.0	48 x 54,5	5.0
<b>SILVYN® KLICK-WM black</b>						
55501115	10 x 1.0	7.0	10.0	12.0	6,5 x 10,0	50.0
55501125	12 x 1.5	8.0	13.0	12.0	10,0 x 13,0	50.0
55501135	16 x 1.5/1	12.0	13.0	12.0	10,0 x 13,0	50.0
55501145	16 x 1.5/2	12.0	15.8	12.0	12 x 15,8	50.0
55501155	20 x 1.5/1	15.5	15.8	13.0	12 x 15,8	50.0
55501165	20 x 1.5/2	15.5	21.2	13.0	16,5 x 21,2	50.0
55501175	25 x 1.5/1	18.0	21.2	13.0	16,5 x 21,2	50.0
55501185	25 x 1.5/2	18.0	28.5	13.0	23 x 28,5	25.0
55501195	32 x 1.5/1	24.0	28.5	15.0	23 x 28,5	25.0
55501205	32 x 1.5/2	24.0	34.5	15.0	29 x 34,5	10.0
55501215	40 x 1.5/1	32.0	34.5	15.0	29 x 34,5	10.0
55501225	40 x 1.5/2	32.0	42.5	15.0	36 x 42,5	10.0
55501235	50 x 1.5/1	39.0	42.5	16.0	36 x 42,5	10.0
55501245	50 x 1.5/2	39.0	54.5	16.0	48 x 54,5	5.0
55501255	63 x 1.5	53.0	54.5	16.0	48 x 54,5	5.0

Photographs are not to scale and do not represent detailed images of the respective products.

## SILVYN® KLICK GPZ-M



### Benefits

- Fast assembly
- Easy to disassemble
- Additional cable strain relief
- Additional cable sealing

### Application range

- In combination with protective conduit
- SILVYN® RILL PA6
- SILVYN® RILL PA12
- Used in areas where cables and wires need to be provided with strain relief and additional sealing
- Nacelle
- Pitch system
- Foundation
- Yaw drives

### Approvals



- UL FILENUMBER E308201

### Design

- Metric connection thread
- Cable gland
- Body with inner sealing
- Upper part with snap-in sleeve

### Technical data

**RAL** Colour delivered  
 Grey (RAL 7001)  
 Black (RAL 9005), UV-resistant

**Material**  
 PA6

**IP** Protection rating  
 IP 68  
 IP 69K according to DIN 40050 T.9

**Temperature range**  
 dynamic: -20°C to +100°C  
 static: -30°C to +100°C

### Note

- For rotating applications, disassemble the upper part to remove sealing, then re-assemble.

### Suitable conduits

- SILVYN® RILL PA 6
- SILVYN® RILL PA 12

Article number	Article designation	Hole Ø (mm)	Clamping range (mm)	Thread length, D (mm)	For conduit with outer Ø (mm)	SW (mm)	Suitable for SILVYN® RILL	Pieces / PU
<b>SILVYN® KLICK, GPZ-M grey</b>								
55500800	12 x 1,5	7.0	4.0 - 6.5	8.0	10.0	16.0	7	20.0
55500810	16 x 1,5	8.0	5.0 - 9.5	8.0	13.0	18.0	9	20.0
55500820	20 x 1,5	10.0	8.0 - 12.0	8.0	15.8	21.0	11	20.0
55500830	25 x 1,5	12.0	11.0 - 16.0	8.0	21.2	27.0	16	10.0
55500840	32 x 1,5	18.0	15.0 - 21.0	11.0	28.5	34.0	21	10.0
55500850	40 x 1,5	25.0	16.0 - 26.0	12.0	34.5	40.0	29	10.0
55500860	50 x 1,5	32.0	27.0 - 35.0	13.0	42.5	49.0	36	10.0
55500870	63 x 1,5	44.0	32.0 - 42.0	14.0	54.5	60.0	48	10.0
<b>SILVYN® KLICK, GPZ-M black</b>								
55500805	12 x 1,5	7.0	4.0 - 6.5	8.0	10.0	16.0	7	20.0
55500815	16 x 1,5	8.0	5.0 - 9.5	8.0	13.0	18.0	9	20.0
55500825	20 x 1,5	10.0	8.0 - 12.0	8.0	15.8	21.0	11	20.0
55500835	25 x 1,5	12.0	11.0 - 16.0	8.0	21.2	27.0	16	10.0
55500845	32 x 1,5	18.0	15.0 - 21.0	11.0	28.5	34.0	21	10.0
55500855	40 x 1,5	25.0	16.0 - 26.0	12.0	34.5	40.0	29	10.0
55500865	50 x 1,5	32.0	27.0 - 35.0	13.0	42.5	49.0	36	10.0
55500875	63 x 1,5	44.0	32.0 - 42.0	14.0	54.5	60.0	48	10.0

Photographs are not to scale and do not represent detailed images of the respective products.

**SILVYN® RKS**

**Benefits**

- Fast and easy mounting
- Various applications

**Application range**

- Fastening clamp for cables, conduits and pipes
- Tower

**Approvals**



- Pitch system

**Technical data**



**Material**  
Steel, galvanised  
Polychloroprene



**Temperature range**  
-35 °C to +100 °C



Article number	Article designation	Metal width (mm)	Width x thickness of rubber profile (mm)	Diameter (mm)	Hole Ø (mm)	Support length (mm)	Pieces / PU
<b>SILVYN® RKS 1</b>							
61825170	6/12	12.0	15 x 1,2	6.0	5.3 (M5)	16.0	100.0
61825180	8/12	12.0	15 x 1,2	8.0	5.3 (M5)	17.0	100.0
61825190	10/12	12.0	15 x 1,2	10.0	5.3 (M5)	18.0	100.0
61825200	12/12	12.0	15 x 1,2	12.0	5.3 (M5)	19.0	100.0
61825210	13/15	15.0	18,5 x 1,5	13.0	6.4 (M6)	23.7	100.0
61825355	14/15	15.0	18,5 x 1,5	14.0	6.4 (M6)	24.2	100.0
61825365	15/15	15.0	18,5 x 1,5	15.0	6.4 (M6)	24.7	100.0
61825375	16/15	15.0	18,5 x 1,5	16.0	6.4 (M6)	25.2	100.0
61825040	18/15	15.0	18,5 x 1,5	18.0	6.4 (M6)	26.2	100.0
61825052	19/15	15.0	18,5 x 1,5	19.0	6.4 (M6)	26.7	100.0
61825380	20/15	15.0	18,5 x 1,5	20.0	6.4 (M6)	27.2	100.0
61825382	21/15	15.0	18,5 x 1,5	21.0	6.4 (M6)	27.7	100.0
61825050	22/15	15.0	18,5 x 1,5	22.0	6.4 (M6)	28.2	100.0
61825390	23/15	15.0	18,5 x 1,5	23.0	6.4 (M6)	28.7	100.0
61825392	24/20	20.0	25 x 1,5	24.0	8.4 (M8)	35.0	100.0
61825400	25/15	15.0	18,5 x 1,5	25.0	6.4 (M6)	29.7	100.0
61825402	26/15	15.0	18,5 x 1,5	26.0	6.4 (M6)	30.2	100.0
61825250	28/15	15.0	18,5 x 1,5	28.0	6.4 (M6)	31.2	100.0
61825255	30/15	15.0	18,5 x 1,5	30.0	6.4 (M6)	32.2	100.0
61825257	32/15	15.0	18,5 x 1,5	32.0	6.4 (M6)	33.2	100.0
61825259	34/15	15.0	18,5 x 1,5	34.0	6.4 (M6)	34.2	100.0
61825260	35/15	15.0	18,5 x 1,5	35.0	6.4 (M6)	34.7	100.0
61825262	36/20	20.0	25 x 1,5	36.0	8.4 (M8)	41.0	100.0
61825264	38/20	20.0	25 x 1,5	38.0	8.4 (M8)	42.0	100.0
61825295	40/20	20.0	25 x 1,5	40.0	8.4 (M8)	43.0	100.0













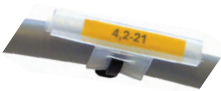







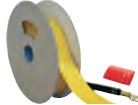









Photographs are not to scale and do not represent detailed images of the respective products.



		BASIC SYSTEM	CUSTOMIZED SYSTEM	
How?	Ready made to deliver for each environment	Your demand - we deliver		
	What?			
CABLE	Outdoor & Indoor	<p>MINI &amp; MAXI &amp; HOLDERS PTE</p> <p>SHRINK TUBES</p> <p>COLLARS TS &amp; HF &amp; MARKING TAGS</p> <p>COLLARS FOR CABLE TIES &amp; MARKING TAGS</p>	<p>STAINLESS STEEL</p> <p>COLLARS FOR CABLE TIES &amp; MARKING TAGS</p> <p>TEXT COLLARS PTET</p>	
	Indoor	<p>LABEL CARDS AND BLOCKS</p> <p>DYMO® printer</p>	<p>SHRINK TUBE MARKING</p> <p>CABLE TIE MARKING FKBB</p>	
	WIRE	before mounting the wire	<p>FLEXIPART</p> <p>PA MARKING RINGS</p>	<p>SHRINK TUBE MARKING</p> <p>FLEXIPART</p> <p>MARKING RINGS</p>
		after mounting the wire	<p>SNAP-ON COLLARS &amp; MARKING TAGS</p> <p>PC MARKING RINGS</p>	<p>SNAP-ON COLLARS &amp; MARKING TAGS</p>
COMPONENT	Device marking	<p>MLM MOUNTING PROFILES &amp; MINI</p> <p>PGS CHARACTER HOLDERS</p>	<p>ENGRAVED MARKING</p>	
	Terminal	<p>TERMINAL BLOCK</p> <p>DYMO® printer</p>	<p>TERMINAL BLOCK</p>	
	Sensor			

DYMO® is a registered trademark of SANFORD GmbH. Photographs are not to scale and do not represent detailed images of the respective products.

**DATA MARKING**

Laser office printer		FLEXIMARK® 10.0		Thermal transfer printers	
					
					
<b>COLLARS FOR CABLE TIES LFL 4,2</b>	<b>FLEXILABEL LFL &amp; HOLDERS PTET/LAB</b>	<b>FLEXILABEL TFL &amp; HOLDERS PTEF/LAB</b>	<b>COLLARS FOR CABLE TIES &amp; MARKING TAGS TMB</b>		
					
<b>LCK/LCFK LABELS</b>	<b>CABLE LABEL LFL &amp; TIES</b>	<b>CABLELABEL LTFL &amp; TIES</b>	<b>TCK LABELS</b>		
					
<b>TAG TIES &amp; LA/LB LABELS</b>	<b>FLEXIMARK® flat shrink tube</b>	<b>TAG TIES &amp; TA LABELS</b>			
					
<b>FLEXIPRINT LF</b>	<b>COLLARS TS/HF &amp; FLEXILABEL LFL 4,2</b>	<b>FLEXIPRINT TF</b>	<b>SHRINKING TUBES SHRINK MARK SM</b>		
					
<b>LCFK/LCK LABELS</b>	<b>BRADY® FLAG LABELS B-425</b>	<b>TCK LABELS</b>	<b>FLAG LABELS</b>	<b>SNAP-ON COLLARS &amp; MARKING TAGS</b>	
					
<b>LA/LB LABELS</b>	<b>LFL LEXEL/THORSMAN</b>	<b>TA LABELS</b>	<b>BRADY® EPREP</b>	<b>MLM MOUNTING PROFILES &amp; TFL 9,5</b>	
					
<b>LA/LB/LC LABELS</b>	<b>TERMINAL BLOCK</b>				
					
<b>CLIP-ON COLLARS &amp; LFL</b>	<b>BRADY® DURASLEEVE</b>	<b>CLIP-ON COLLARS &amp; MARKING TAGS</b>			

Photographs are not to scale and do not represent detailed images of the respective products.

Resistance of FLEXIMARK® labels																				
Product	Material	Temperature Range	Resistance			Chemical						Chemical resistance and abrasion test								
			UV-light	Ageing	Abrasion of the marking text	Diesel	Acid (H2SO4), 25%	Alkali (Detergent solution, 10%)	Distilled water	Salt water (5% NaCl)	Transformer oil (Nytro 10X)	Ethanol	Diesel	Acid (H2SO4), 25%	Alkali (Detergent solution, 10%)	Distilled water	Salt water (5% NaCl)	Transformer oil (Nytro 10X)	Ethanol	
LCK Wrapping labels	Polyester	-40°C - +125°C	■	■	■															
Flexiprint LF	Polyester	-40°C - +125°C	■	■	■															
Flexipart	Polyester	-40°C - +100°C	□	■	■															
LFL cable label	Polyester	-40°C - +125°C	■	■	■															
LB labels	Polyester	-40°C - +125°C	■	■	■															
Flexiprint TF	Polyester	-40°C - +125°C	■	■	■															
Character holders MINI	PTE	-75°C - +80°C	■	■	■															
Character holders PTEF/CAB	PTE	-75°C - +80°C	■	■	■															
Characters strips plastic MINI	PVC	-20°C - +65°C	■	■	■															
TA Labels Cable marking	Polyester	-40°C - +150°C	■	■	■															
Flexi sleeve FS	PVC	-15°C - +90°C	■	■	■															
Shrink tube marking	Polyolefin	-55°C - +125°C	■	■	□															
Collars	PUR+PE	-40°C - +80°C	■	■	■															
Character holders PGS - MINI	ABS	-20°C - +45°C	■	■	■															
MINI FCC Cable marking system	PE	-30°C - +70°C	■	■	□															
Stainless steel marking FCC	SS 2348	max +500°C	■	■	■															

■ = high    ■ = medium    □ = none

To meet the high requirements of our products and to ensure our quality standard all FLEXIMARK® products are subjected to a series of strict tests. These are made

by the independent SP Technical Research Institute of Sweden using the SP 2171 Test Method which is used especially for collars and plastic information carrier which mark

electric wires, cables, components and clamps. For receiving an impression, some of the tests are listed below:

Test	Method and criteria
Ageing resistance	Accelerated ageing in heat oven (2000 days at 90°C (194°F) corresponding to use at 20°C (+68°F) for 30 years. Check for cracks, breaks or similar damage. (Max 50% reduction in elongation before breakage.) Also check for mountability and dismountability.
UV-resistance	Accelerating test corresponding to ISO 4892-2 exposure 1 year outdoors in southern Sweden. Check for brittleness and change in colour and readability.
Abrasion resistance of marking text	According to SP Method 2172 (rubbing machine). Load 75 g per mm mandrel diameter. 200+200 cycles.
Chemical resistance	Mounted sleeves kept for 24 hours at +23°C & -2°C (+73.4°F & 28.4°F) immersed in the chemical. Drying for 2 hours then check for functionality, colour fastness and print legibility.  Chemicals used: Synthetic diesel oil, Sulphuric acid 25%, basic cleaning agent (Berol226, 10%), Distilled water, Sea water (5% NaCl), Transformer oil (Nytro 10x), Ethanol, other chemicals on request.
Chemical resistance with Abrasion test	Combination of abrasion-test and chemical resistance-test.

Note: actual version and further information are available on our homepage

**Tube cable lugs KR/ KRT/ KRF**

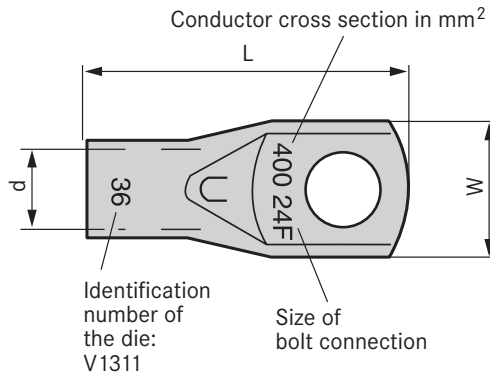

Tube cable lugs KR/ KRT/ KRF

**Benefits**

- Premium cables and wires for railway vehicles

**Application range**

- KR  
For fine and multi-wire copper conductors with a cross-sectional range of 0.75 - 10.00 mm<sup>2</sup>
- KRT  
For multi-wire copper conductors with a cross-sectional range of 10 - 400 mm<sup>2</sup>
- KRF  
For fine-wire copper conductors with a cross-sectional range of 16 - 400 mm<sup>2</sup>
- Tower cable
- Generator
- Yaw drives
- Pitch drives

**Approvals**



- File Number E205350, see main catalogue 2012

**Design**

- For fine and multi-wire copper conductors with a cross section range of 0.75 - 10 mm<sup>2</sup>

**Suitable tools**

- T 2288 pressing pliers refer to main catalogue 2012 page 929
- V 1311 pressing pliers, hydraulic refer to main catalogue 2012 page 930

**Technical data**

- General**  
Inspection hole
- Approvals**  
UL-recognised
- Material**  
Tinned electrolyte copper
- Temperature range**  
Temperature range up to +90°C  
Working temperature: 110°C, max. +200°C

Article number	Article designation	Screw hole Ø (mm)	UL approval	Length (mm)	Pressing dies	d mm	W mm	Pieces / PU
<b>KR</b>								
61796480	KR/0,75	3	no	16		1.3	6.0	100
61796490	KR/0,75	4	no	16		1.3	6.0	100
61796500	KR/1,5	3	yes	16		1.8	6.5	100
61796510	KR/1,5	4	yes	17		1.8	6.5	100
61796520	KR/1,5	5	yes	18		1.8	7.5	100
61796530	KR/2,5	3	yes	17		2.3	7.5	100
61796540	KR/2,5	4	yes	18		2.3	7.5	100
61796550	KR/2,5	5	yes	19		2.3	8.5	100
61796560	KR/2,5	6	yes	19		2.3	8.5	100
61796570	KR/4	4	yes	21		3.0	8.5	100
61796580	KR/4	5	yes	22		3.0	9.0	100
61796590	KR/4	6	yes	23		3.0	10.0	100
61796600	KR/6	4	yes	22		4.0	9.5	100
61796610	KR/6	5	yes	22		4.0	9.5	100
61796620	KR/6	6	yes	23		4.0	10.0	100
61796630	KR/6	8	yes	30		4.0	13.5	100
61796631	KR/10	5	yes	29	B 7 / B 8	5.0	11.5	100
61796632	KR/10	6	yes	29	B 7 / B 8	5.0	11.5	100
61796633	KR/10	8	yes	33	B 7 / B 8	5.0	13.5	100
<b>KRT</b>								
61796640	KRT/10	5	yes	29	B 7	4.5	10.0	100
61796650	KRT/10	6	yes	29	B 7	4.5	10.0	100
61796660	KRT/10	8	yes	34	B 7	4.5	13.0	100
61796670	KRT/10	10	yes	34	B 7	4.5	16.0	100
61796680	KRT/10	12	yes	41	B 7	4.5	19.0	100
61796690	KRT/16	5	yes	34	B 8.5	5.5	12.0	100
61796700	KRT/16	6	yes	34	B 8.5	5.5	12.0	100
61796710	KRT/16	8	yes	39	B 8.5	5.5	15.0	100
61796720	KRT/16	10	yes	39	B 8.5	5.5	16.0	100
61796730	KRT/16	12	yes	44	B 8.5	5.5	19.0	100
61796740	KRT/25	6	yes	43	B 10	7.0	14.0	100
61796750	KRT/25	8	yes	43	B 10	7.0	15.0	100
61796760	KRT/25	10	yes	43	B 10	7.0	16.0	100
61796770	KRT/25	12	yes	48	B 10	7.0	19.0	100
61796780	KRT/35	6	yes	48	B 12	8.5	17.0	100
61796790	KRT/35	8	yes	48	B 12	8.5	17.0	100
61796800	KRT/35	10	yes	48	B 12	8.5	19.0	100
61796810	KRT/35	12	yes	53	B 12	8.5	19.0	50
61796820	KRT/50	6	yes	53	B 14	10.0	20.0	50
61796830	KRT/50	8	yes	53	B 14	10.0	20.0	50
61796840	KRT/50	10	yes	53	B 14	10.0	20.0	50
61796850	KRT/50	12	yes	56	B 14	10.0	22.0	50

Connection and crimping

Tube cable lugs

Article number	Article designation	Screw hole Ø (mm)	UL approval	Length (mm)	Pressing dies	d mm	W mm	Pieces / PU
61796860	KRT/70	8	yes	55	B 16	12.0	23.0	50
61796870	KRT/70	10	yes	55	B 16	12.0	23.0	50
61796880	KRT/70	12	yes	58	B 16	12.0	23.0	50
61796890	KRT/95	8	yes	60	B 18	13.5	26.0	50
61796900	KRT/95	10	yes	60	B 18	13.5	26.0	50
61796910	KRT/95	12	yes	63	B 18	13.5	26.0	50
61796920	KRT/95	16	yes	69	B 18	13.5	28.0	50
61796930	KRT/120	10	yes	64	B 19	15.0	28.0	50
61796940	KRT/120	12	yes	64	B 19	15.0	28.0	50
61796950	KRT/120	16	yes	70	B 19	15.0	28.0	50
61796960	KRT/150	12	no	76	B 22	17.0	32.0	25
61796970	KRT/150	16	no	76	B 22	17.0	32.0	25
61796980	KRT/150	20	no	83	B 22	17.0	32.0	25
61796990	KRT/185	12	no	79	13 B 24	19.0	35.0	25
61797000	KRT/185	16	no	79	13 B 24	19.0	35.0	25
61797010	KRT/185	20	no	86	13 B 24	19.0	35.0	25
61797020	KRT/240	12	no	86	13 B 26	21.0	38.0	25
61797030	KRT/240	16	no	86	13 B 26	21.0	38.0	25
61797040	KRT/240	20	no	93	13 B 26	21.0	38.0	25
61797050	KRT/300	16	no	100	13 B 30	24.0	44.0	10
61797080	KRT/400	20	no	114	13 B 32	26.0	48.0	10
<b>KRF</b>								
61803020	KRF/16	6	yes	33	B 9	6.0	13.0	100
61803030	KRF/16	8	yes	33	B 9	6.0	13.0	100
61803040	KRF/16	10	yes	38	B 9	6.0	16.0	100
61803050	KRF/16	12	yes	47	B 9	6.0	22.0	100
61803060	KRF/25	6	yes	37	B 11	8.0	16.0	100
61803070	KRF/25	8	yes	38	B 11	8.0	16.0	100
61803080	KRF/25	10	yes	42	B 11	8.0	17.0	100
61803090	KRF/25	12	yes	47	B 11	8.0	22.0	100
61803110	KRF/35	6	yes	45	B 13	9.0	18.0	100
61803120	KRF/35	8	yes	47	B 13	9.0	18.0	100
61803130	KRF/35	10	yes	45	B 13	9.0	18.0	100
61803140	KRF/35	12	yes	52	B 13	9.0	22.0	100
61803160	KRF/50	8	yes	50	B 14.4	11.0	21.0	100
61803170	KRF/50	10	yes	50	B 14.5	11.0	21.0	100
61803180	KRF/50	12	yes	53	B 14.5	11.0	21.0	100
61803190	KRF/50	16	yes	59	B 14.5	11.0	27.0	100
61803200	KRF/70	8	yes	55	B 17	13.0	25.0	50
61803210	KRF/70	10	yes	55	B 17	13.0	25.0	50
61803220	KRF/70	12	yes	58	B 17	13.0	25.0	50
61803230	KRF/70	16	yes	64	B 17	13.0	28.0	50
61803240	KRF/95	10	yes	69	B 20	15.0	29.0	50
61803250	KRF/95	12	yes	69	B 20	15.0	29.0	50
61803260	KRF/95	16	yes	69	B 20	15.0	29.0	50
61803270	KRF/120	10	yes	73	B 22	17.0	32.0	25
61803280	KRF/120	12	yes	73	B 22	17.0	32.0	25
61803290	KRF/120	16	yes	73	B 22	17.0	32.0	25
61803300	KRF/150	12	yes	80	B 25/13 B 25	19.0	36.0	25
61803310	KRF/150	16	yes	80	B 25/13 B 25	19.0	36.0	25
61803330	KRF/185	12	yes	86	13 B 27	21.0	39.0	20
61803340	KRF/185	16	yes	86	13 B 27	21.0	39.0	20
61803350	KRF/185	20	yes	93	13 B 27	21.0	39.0	20
61803360	KRF/240	12	yes	95	13 B 30	22.5	42.0	10
61803370	KRF/240	16	yes	95	13 B 30	22.5	42.0	10
61803380	KRF/240	20	yes	95	13 B 30	22.5	42.0	10
61803390	KRF/300	16	yes	114	13 B 32	24.5	45.0	10
61803400	KRF/300	20	yes	114	13 B 32	24.5	45.0	10
61803420	KRF/400	16	yes	126	13 B 38	30.0	56.0	10
61803430	KRF/400	20	yes	126	13 B 38	30.0	56.0	10
61803440	KRF/400	24	yes	126	13 B 38	30.0	56.0	10

Photographs are not to scale and do not represent detailed images of the respective products.

■ Similar products

- Cable lugs KB refer to main catalogue 2012 page 920

ÖLFLEX®  
UNITRONIC®  
ETHERLINE®  
HITRONIC®  
EPIC®  
SKINTOP®  
SILVYN®  
FLEXIMARK®  
ACCESSORIES

**PLG - HSB box shrink tube**

**Benefits**

- Designed for effective electrical insulation
- A viewing window allows for content inspection.

**Application range**

- This flexible and quick-shrinking tube can be used everywhere for bundling, insulation and marking.
- Nacelle
- Tower
- Top/Bottom Box

**Approvals**



**Technical data**



**General**  
Cadmium-free



**Note**  
Good chemical-resistance  
UV-resistant - black



**Info**  
Shrinking ratio: 2:1  
Length change during shrinking: maximum ±10 %



**Material**  
Cross-linked polyolefin, thin wall  
Transparent = halogen-free



**Temperature range**  
-55°C to +125°C  
Shrinking temperature: +120°C



**Suitable tools**

- HG 2310 LCD hot-air pistol refer to main catalogue 2012 page 950

Article number	Article description	Internal Ø before contraction (mm)	Shrinkage range (mm)	Panel thickness, shrunk ± 0.1 mm	Contents (m)	PU
<b>Black</b>						
61752220	HSB 46-0	1.2	1.2 - 0.6	0.4	12.0	1
61752230	HSB 63-0	1.6	1.6 - 0.8	0.4	12.0	1
61752240	HSB 93-0	2.4	2.4 - 1.2	0.5	11.5	1
61752250	HSB 125-0	3.2	3.2 - 1.6	0.5	11.5	1
61752260	HSB 187-0	4.7	4.7 - 2.4	0.5	9.5	1
61752270	HSB 250-0	6.4	6.4 - 3.2	0.6	7.5	1
61752280	HSB 375-0	9.5	9.5 - 4.8	0.6	6.5	1
61752290	HSB 500-0	12.7	12.7 - 6.4	0.7	6.0	1
61752300	HSB 750-0	19.1	19.1 - 9.5	0.7	5.0	1
61752310	HSB 1000-0	25.4	25.4 - 12.7	0.8	3.3	1
<b>Transparent</b>						
61752830	HSB 46-C	1.2	1.2 - 0.6	0.4	12.0	1
61752840	HSB 63-C	1.6	1.6 - 0.8	0.4	12.0	1
61752850	HSB 93-C	2.4	2.4 - 1.2	0.5	11.5	1
61752860	HSB 125-C	3.2	3.2 - 1.6	0.5	11.5	1
61752870	HSB 187-C	4.7	4.7 - 2.4	0.5	9.5	1
61752880	HSB 250-C	6.4	6.4 - 3.2	0.6	7.5	1
61752890	HSB 375-C	9.5	9.5 - 4.8	0.6	6.5	1
61752900	HSB 500-C	12.7	12.7 - 6.4	0.7	6.0	1
61752910	HSB 750-C	19.1	19.1 - 9.5	0.7	5.0	1
61752920	HSB 1000-C	25.4	25.4 - 12.7	0.8	3.3	1

Other colours are available upon request.

Photographs are not to scale and do not represent detailed images of the respective products.

## Basic Tie cable tie



### Benefits

- High resistance to bases, oils, greases, oil derivatives, solvents containing chlorine

### Application range

- Basic Tie is a multipurpose cable tie for many applications.
- Inside WIG e.g.
- Tower
- Pitch
- Nacelle

### Product features

- Flame retardancy: UL 94 class V2.
- Water absorption: 2.5 % (50 % relative humidity)

### Approvals



### Note

- Not resistant to phenols
- Limited resistance to acids



### Info

- The standard cable ties for many applications

### Technical data



#### General

Dielectric strength:  
50,000 volts/mm  
For higher tensile strength



#### Note

Melting point: +256 °C



#### Material

Polyamide 6.6 - halogen-free



#### Temperature range

-40 °C to +85 °C  
Max. temperature: +110 °C (short-term)

Article number	Article description	UL approval	Length x width (mm)	Bundling Ø (mm)	Tensile strength (N)	PU
<b>natural</b>						
61831001	Basic Tie 98x2.5 nat.	yes	98.0 x 2.5	1.0 - 21.0	80	1,000
61831003	Basic Tie 160x2.6 nat.	yes	160.0 x 2.6	1.0 - 40.0	80	1,000
61831004	Basic Tie 200x2.6 nat.	yes	200.0 x 2.6	1.0 - 52.0	80	1,000
61831005	Basic Tie 140x3.6 nat.	yes	140.0 x 3.6	2.0 - 35.0	130	1,000
61831006	Basic Tie 200x3.6 nat.	yes	200.0 x 3.6	2.0 - 50.0	130	1,000
61831007	Basic Tie 290x3.6 nat.	yes	290.0 x 3.6	2.0 - 80.0	130	500
61831013	Basic Tie 370x3.6 nat.	yes	370.0 x 3.6	2.0 - 103.0	130	100
61831009	Basic Tie 160x4.5 nat.	yes	160.0 x 4.5	2.5 - 40.0	220	1,000
61831011	Basic Tie 200x4.8 nat.	yes	200.0 x 4.8	3.0 - 50.0	220	1,000
61831014	Basic Tie 290x4.8 nat.	yes	290.0 x 4.8	3.5 - 79.0	220	100
61831016	Basic Tie 360x4.8 nat.	yes	360.0 x 4.8	3.5 - 103.0	220	100
61831020	Basic Tie 240x7.8 nat.	yes	240.0 x 7.8	3.5 - 63.0	540	100
61831021	Basic Tie 300x7.8 nat.	yes	300.0 x 7.8	4.0 - 80.0	540	100
61831022	Basic Tie 365x7.8 nat.	yes	365.0 x 7.8	8.0 - 100.0	540	100
61831023	Basic Tie 450x7.8 nat.	yes	450.0 x 7.8	35.0 - 130.0	540	100
61831024	Basic Tie 540x7.8 nat.	yes	540.0 x 7.8	35.0 - 158.0	540	100
61831025	Basic Tie 750x7.8 nat.	yes	750.0 x 7.8	35.0 - 200.0	540	100
61831026	Basic Tie 780x9.0 nat.	yes	780.0 x 9.0	32.0 - 233.0	700	100
<b>UV-resistant - black</b>						
61831041	Basic Tie 98x2.5 bk	yes	98.0 x 2.5	1.0 - 21.0	80	1,000
61831043	Basic Tie 160x2.6 bk	yes	160.0 x 2.6	1.0 - 40.0	80	1,000
61831044	Basic Tie 200x2.6 bk	yes	200.0 x 2.6	1.0 - 52.0	80	1,000
61831045	Basic Tie 140x3.6 bk	yes	140.0 x 3.6	2.0 - 35.0	130	1,000
61831046	Basic Tie 200x3.6 bk	yes	200.0 x 3.6	2.0 - 50.0	130	1,000
61831047	Basic Tie 290x3.6 bk	yes	290.0 x 3.6	2.0 - 80.0	130	500
61831053	Basic Tie 370x3.6 bk	yes	370.0 x 3.6	2.0 - 103.0	130	100
61831049	Basic Tie 160x4.5 bk	yes	160.0 x 4.5	2.5 - 40.0	220	1,000
61831051	Basic Tie 200x4.8 bk	yes	200.0 x 4.8	3.0 - 50.0	220	1,000
61831054	Basic Tie 290x4.8 bk	yes	290.0 x 4.8	3.5 - 79.0	220	100
61831056	Basic Tie 360x4.8 bk	yes	360.0 x 4.8	3.5 - 103.0	220	100
61831060	Basic Tie 240x7.8 bk	yes	240.0 x 7.8	3.5 - 63.0	540	100
61831061	Basic Tie 300x7.8 bk	yes	300.0 x 7.8	4.0 - 80.0	540	100
61831062	Basic Tie 365x7.8 bk	yes	365.0 x 7.8	8.0 - 100.0	540	100
61831063	Basic Tie 450x7.8 bk	yes	450.0 x 7.8	35.0 - 130.0	540	100
61831064	Basic Tie 540x7.8 bk	yes	540.0 x 7.8	35.0 - 158.0	540	100
61831065	Basic Tie 750x7.8 bk	yes	750.0 x 7.8	35.0 - 200.0	540	100
61831066	Basic Tie 780x9.0 bk	yes	780.0 x 9.0	32.0 - 233.0	700	100

Photographs are not to scale and do not represent detailed images of the respective products.

**New**

## Twist Tail™ cable tie



**Info**

- No special tool needed
- Worked instantly

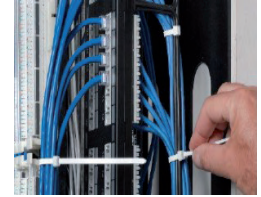

**Benefits**

- The round, flat, edge-free tie-heads allow assembly without getting caught and protect against injury and damage at adjacent cables and components.
- The cable tie can be gripped securely for easy tightening.
- In addition, the safety-grip tab prevents the tie from slipping out during assembly, and secures it before tightening by hand.

**Application range**

- Industrial cable ties for quick and secure assembly
- General purpose applications, indoors and outdoors
- Nacelle
- Top/Bottom Box

**Approvals**



**Design**

- Wrap the cable tie around a bundle of cables, bend the excess tail in two directions and twist. The tail breaks right off, leaving no sharp edges to scratch your hands or your cables.
- Available in 3 different lengths and 2 colours (white and UV-resistant black)

**Technical data**

- General**  
Tensile strength: 133 N
- Approvals**  
Flammability class: UL 94 V-2/polyamide 6.6
- Note**  
Halogen-free  
silicone-free
- Colour delivered**  
Black (RAL 9005), UV-resistant  
white
- Material**  
Polyamide 6.6
- Temperature range**  
-40 °C to +85 °C

Article number	Article description	UL approval	Length (mm)	Max. bundle Ø (mm)	Pieces / PU
<b>white</b>					
61832007	TWIST TAIL TT-7-30-9-L	yes	181	45.0	50
61832009	TWIST TAIL TT-11-30-0-L	yes	282	76.0	50
61832011	TWIST TAIL TT-14-30-9-L	yes	358	102.0	50
<b>Black (RAL 9005), UV-resistant</b>					
61832008	TWIST TAIL TT-7-30-0-L	yes	181	45.0	50
61832010	TWIST TAIL TT-11-30-0-L	yes	282	76.0	50
61832012	TWIST TAIL TT-14-30-0-L	yes	358	102.0	50

TWIST TAIL™ is a registered trademark of Thomas & Betts  
Photographs are not to scale and do not represent detailed images of the respective products.

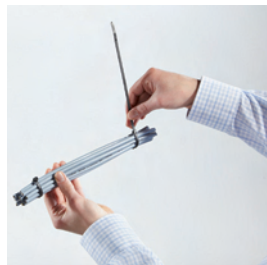
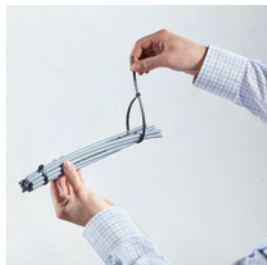



## TY - FAST® - UV-resistant cable ties / TY - FAST® standard cable ties



TY - FAST® standard cable ties

### Benefits

#### TY - FAST® standard cable ties

- TY-FAST® cable ties have low threading and high tying forces due to their integrated lock.
- The round, flat, edge-free tie-heads allow assembly without getting caught and protect against injury and damage at adjacent cables and components.
- The raised tie end and the "SURE-GRIP" gripping profile on both sides of the tie end offer improved grip.
- The cable tie can be gripped securely for easy tightening.
- In addition, the safety-grip tab prevents the tie from slipping out during assembly, and secures it before tightening by hand or with a tool.

### Application range

#### TY - FAST® standard cable ties

- Cable ties for industrial applications
- Industrial cable ties for quick and secure assembly

#### TY - FAST®- UV-resistant cable ties

- Cable ties for industrial applications

#### TY - FAST® standard cable ties

#### TY - FAST®- UV-resistant cable ties

- Tower
- Nacelle
- Pitch
- Top/Bottom Box

### Approvals



#### TY - FAST® standard cable ties

- File Number E49405, see main catalogue 2012

### Design

#### TY - FAST®- UV-resistant cable ties

- TY-FAST® cable ties are also available in UV-resistant and weather-resistant design, in black.
- The description for these cable ties are marked with "x".

### Suitable tools

- TY-GUN ERG 50 / TY-GUN ERG 120 cable tie pliers refer to main catalogue 2012 page 962

### Technical data



#### Approvals

**TY - FAST® standard cable ties**  
Flammability class: UL 94 V-2/polyamide 6.6



#### Info

**TY - FAST®- UV-resistant cable ties**  
In black colour UV-resistant and weather-proofed  
Halogen-free



#### Colour delivered

**TY - FAST®- UV-resistant cable ties**  
Black



#### Material

**TY - FAST® standard cable ties**  
Polyamide 6.6 - halogen-free  
**TY - FAST®- UV-resistant cable ties**  
Polyamide 6.6



#### Temperature range

-40°C to +80°C

Article number	Article description	UL approval	Length x width (mm)	Bundling Ø (mm)	Tensile strength (N)	Pieces / PU
<b>natural</b>						
61810350	TY100-18	yes	111.0 x 2.4	25.0	80.0	1,000
61810360	TY125-18	yes	136.0 x 2.4	32.0	80.0	1,000
61810370	TY200-18	yes	197.0 x 2.4	50.0	80.0	1,000
61810380	TY125-40	yes	142.0 x 3.6	32.0	180.0	1,000
61810390	TY200-40	yes	205.0 x 3.6	50.0	180.0	1,000
61810400	TY300-40	yes	290.0 x 3.6	76.0	180.0	1,000
61810410	TY175-50	yes	186.0 x 4.7	44.0	220.0	1,000
61810420	TY300-50	yes	291.0 x 4.7	76.0	220.0	1,000
61810430	TY400-50	yes	368.0 x 4.7	102.0	220.0	1,000
61810440	TY200-120	no	219.0 x 7.6	50.0	540.0	500
61810450	TY400-120	yes	365.0 x 7.6	102.0	540.0	500
<b>UV-resistant - black</b>						
61810460	TY100-18x	yes	111.0 x 2.4	25.0	80.0	1,000
61810470	TY125-18x	yes	136.0 x 2.4	32.0	80.0	1,000
61810480	TY200-18x	yes	197.0 x 2.4	50.0	80.0	1,000
61810490	TY125-40x	yes	142.0 x 3.6	32.0	180.0	1,000
61810500	TY200-40x	yes	205.0 x 3.6	50.0	180.0	1,000
61810510	TY300-40x	yes	290.0 x 3.6	76.0	180.0	1,000
61810520	TY175-50x	yes	186.0 x 4.7	44.0	220.0	1,000
61810530	TY300-50x	yes	291.0 x 4.7	76.0	220.0	1,000
61810540	TY400-50x	yes	368.0 x 4.7	102.0	220.0	1,000
61810550	TY200-120x	no	219.0 x 7.6	50.0	540.0	500
61810560	TY400-120x	no	365.0 x 7.6	102.0	540.0	500

TY-FAST® is a registered trademark of Thomas & Betts

Photographs are not to scale and do not represent detailed images of the respective products.

## TY- RAP® heat-resistant cable ties

### Benefits

- Contains all the advantages of TY-RAP®, with higher heat-resistance

### Application range

- This temperature-resistant cable tie can be used in areas exposed to high temperatures such as electrical heating devices or heating installations.
- Gear Box
- Cooling system

### Technical data



**Approvals**  
Flammability class: UL 94 V-2/polyamide 6.6



**Info**  
Halogen-free and silicone-free



**Material**  
Heat-resistant polyamide 6.6



**Temperature range**  
-40°C to +100°C



### Approvals



- File Number E49405, main catalogue 2012

### Design

- Colour: yellow transparent
- Heat-resistant cable ties have the extension "M"

### Suitable tools

- TY-GUN ERG 50 / TY-GUN ERG 120 cable tie pliers refer to main catalogue 2012 page 962

Article number	Article description	UL approval	Length x width (mm)	Bundling Ø (mm)	Tensile strength (N)	Pieces / PU
<b>TY-RAP® heat-resistant</b>						
61723470	TYH 23 M	yes	92.0 x 2.4	2.0 - 16.0	80.0	1,000
61723460	TYH 232 M	yes	200.0 x 2.4	2.0 - 50.0	80.0	1,000
61723440	TYH 24 M	yes	140.0 x 3.6	2.0 - 29.0	180.0	1,000
61723430	TYH 242 M	no	208.0 x 3.6	2.0 - 50.0	180.0	1,000
61723410	TYH 26 M	yes	281.0 x 3.6	2.0 - 76.0	180.0	1,000
61723420	TYH 25 M	yes	186.0 x 4.8	3.5 - 45.0	220.0	1,000
61723380	TYH 28 M	yes	360.0 x 4.8	3.5 - 102.0	220.0	1,000
61723390	TYH 272 M	no	223.0 x 7.6	6.0 - 50.0	540.0	500
61723400	TYH 27 M	yes	340.0 x 7.0	6.0 - 90.0	540.0	500
61723350	TYH 29 M	no	762.0 x 7.6	6.0 - 229.0	540.0	500

TY-RAP® is a registered trademark of Thomas & Betts

Photographs are not to scale and do not represent detailed images of the respective products.

## TY- RAP® weather-proof, UV-stabilised

### Benefits

- Weather-resistant for harsh environmental conditions

### Application range

- The TY-RAP® weather-resistant product is used outdoors for installation and maintenance of power plants.
- Tower
- Nacelle

### Product features

- Heat and UV-resistant TY- RAP®



### Info

- Good quality cable ties with steel blade

### Technical data



**Colour delivered**  
RAL 9005 black/UV-resistant



**Material**  
Polyamide 6.6 - halogen-free



**Temperature range**  
-40°C to +85°C

### Approvals



- File Number E49405, main catalogue 2012



Article number	Article description	UL approval	Length x width (mm)	Bundling Ø (mm)	Tensile strength (N)	Pieces / PU
<b>TY-RAP® weather-resistant</b>						
61723010	TYB* 23 MX	no	92.0 x 2.4	2.0 - 16.0	80.0	1,000
61723160	TY 272 MX	no	223.0 x 7.6	6.0 - 50.0	540.0	500
61723050	TY 27 MX	yes	340.0 x 7.0	6.0 - 90.0	540.0	500
61723070	TY 29 MX	no	762.0 x 7.6	6.0 - 229.0	540.0	500
61723060	TY 28 MX	yes	360.0 x 4.8	3.5 - 102.0	220.0	1,000
61723150	TY 253 MX	no	293.0 x 4.8	3.5 - 78.0	220.0	1,000
61723030	TYB* 25 MX	no	186.0 x 4.8	3.5 - 45.0	220.0	1,000
61723140	TY 244 MX	no	368.0 x 3.6	2.0 - 103.0	180.0	1,000
61723040	TY 26 MX	yes	281.0 x 3.6	2.0 - 76.0	180.0	1,000
61723130	TY 242 MX	yes	208.0 x 3.6	2.0 - 50.0	180.0	1,000
61723020	TYB* 24 MX	no	140.0 x 3.6	2.0 - 29.0	180.0	1,000
61723120	TY 234 MX	no	356.0 x 2.4	2.0 - 102.0	80.0	1,000
61723110	TY 232 MX	no	200.0 x 2.4	2.0 - 50.0	80.0	1,000

TY-RAP® is a registered trademark of Thomas & Betts

Photographs are not to scale and do not represent detailed images of the respective products.



#### For the use of our products is valid

The conformity of our products with the relevant European directives and compliance with the provisions contained therein shall be indicated by the CE marking.

The safety of our products is closely associated with how they are used. A knowledge of and adherence to the respective international/national standards of use (e.g. DIN VDE 0100; 0298) are mandatory.

There are particular risks if installed improperly. This applies to all our products/items:

**Processing is only to be done by an authorized electrician! Otherwise, there is the risk of an electric shock or a fire ignited by electric current!**

#### Safety

Without exception our products are tested for application safety in accordance with laid down standards and our own regulations, which complement the standards. Relevant legal requirements and safety regulations are also observed. Provided due care and attention is paid, the possibility of product-specific danger to the user may thus reasonably be excluded. Where products are used carelessly or incorrectly, however, considerable

danger to persons and the environment may arise. For this reason, our cables must only be processed and/or used responsibly by trained electricians or specialists. This catalogue contains general information for the application of each product. Independent of such information, the application standards DIN VDE 0298 and DIN VDE 001 for cables will apply. Excerpts from these standards, as well as complementary selection and

application tables, design and installation guidelines, are contained in the tables in the appendix to our current Main Catalogue. Our machines and installation tools are – where necessary – designed in accordance with the machine guidelines and display the CE identification mark. It must be noted, however, that our machines and installation tools must only be used by trained specialized personnel and for the purpose for

which they were designed. ©Copyright by U.I. Lapp GmbH. Reprinting or reproduction of the text or the illustrations may be made only with written approval and with correct indication of source. We reserve the right to make modifications to our products, especially those based on technical improvements or continued development. All illustrations and numerical data etc. are therefore without warranty and are subject to change.



**ÖLFLEX®**  
Cabos de ligação e de controle



**UNITRONIC®**  
Sistemas de comunicação de dados



**ETHERLINE®**  
Sistema de comunicação de dados para tecnologia ETHERNET



**HITRONIC®**  
Sistemas de transmissão ótica



**EPIC®**  
Conectores industriais



**SKINTOP®**  
Prensa-cabos



**SILVYN®**  
Sistemas de condútes protetores para cabos e esteiras porta-cabos



**FLEXIMARK®**  
Sistemas de identificadores

**BASE**  
**AUTOMAÇÃO**

Siga o LAPP em



Termos de troca:  
Nossas condições gerais de venda podem ser baixadas em nosso site [lappbrasil.lappgroup.com/termos-de-troca](http://lappbrasil.lappgroup.com/termos-de-troca)



Cabos Lapp Brasil Ltda.  
Av. Dr. Mauro Lindemberg Monteiro, 628 - Galpão 18  
CEP 06278-010 Osasco-SP  
Tel.: +55 11 21664166  
[www.lappgroup.com.br](http://www.lappgroup.com.br) [vendas.lbr@lappgroup.com.br](mailto:vendas.lbr@lappgroup.com.br)

(11) 4456-4321 (11) 97885-1596

[COMERCIAL@BASEAUTOMACAO.COM.BR](mailto:COMERCIAL@BASEAUTOMACAO.COM.BR)

[WWW.BASEAUTOMACAO.COM.BR](http://WWW.BASEAUTOMACAO.COM.BR)